



2004

MODEL YEAR VEHICLES

SELECTION LIST

Isolation Module System Snowplows



Lit. No. 64308
June 1, 2006
Revision 08

This document supersedes all editions with an earlier date.

TABLE OF CONTENTS

About the <i>Selection List</i>	3	Nissan Attachment Kits	36
Selection Example	4	Toyota Attachment Kits	37
Chevy/GMC Attachment Kits	5	Headlamp Reference Guide	38
Dodge Attachment Kits	14	Weight and Dimensional Charts	39
Ford Attachment Kits	18	Dimensional Diagram	40
International Attachment Kits	33	Ballast Inquiry Sheet	41
Jeep Attachment Kits	34	UltraMount® System to UniMount® System	
Mazda Attachment Kits	35	Conversion Kit	42

ABBREVIATION KEY			
---	No Application	NTEA	National Truck Equipment Association
4WS	Four Wheel Steering	OEM	Original Equipment Manufacturer
4x2	Two Wheel Drive	OHC	Overhead Cam
4x4	Four Wheel Drive	PN	Part Number
A,Q&L	A-Frame, Quadrant & Lift Frame	RGAWR	Rear Gross Axle Weight Rating
AWD	All Wheel Drive	SL	Selection List
CG	Center of Gravity	SU-2DR	Two Door Sport/Utility Vehicle
Chassis	Chassis Cab or Cab Chassis	SU-4DR	Four Door Sport/Utility Vehicle
DIA	Diameter	SUB	Suburbanite™ Snowplow
DRW	Dual Rear Wheels	UHW	UniMount® Heavy Weight Snowplow
Ext Cab	Extended Cab Vehicle	UTM	UltraMount® MIDWEIGHT™ Snowplow
FFV	Flex Fuel Vehicle	UTMY	UltraMount MIDWEIGHT Poly Snowplow
FGAWR	Front Gross Axle Weight Rating	UTMVP	UltraMount MVP® Snowplow
FMVSS	Federal Motor Vehicle Safety Standards	UTMVPP	UltraMount MVP PLUS Snowplow
GVWR	Gross Vehicle Weight Rating	UTMVPPY	UltraMount Poly MVP PLUS Snowplow
HD	Heavy Duty	UTP	UltraMount PRO-PLOW® Snowplow
HO	High Output	UTPP	UltraMount PRO PLUS® Snowplow
HYD	Hydraulic	UTPY	UltraMount POLY PRO-PLOW Snowplow
MIN	Minimum	w/	With
MVP	MultiPosition V-Plow	w/o	Without
MVPP	MVP PLUS™ Snowplow		

⚠ WARNING

New untitled vehicle installation of a snowplow requires National Highway Traffic Safety Administration altered vehicle certification labeling. Installer to verify that selected snowplow and ballast, if required, do not exceed GVWR or GAWR rating label and complies with FMVSS.

⚠ WARNING

Do not exceed GVWR or GAWR, including blade and ballast. The rating label is found on the driver-side vehicle door cornerpost.

ABOUT THE SELECTION LIST

The *Selection List (SL)* is designed to help you determine the appropriate snowplow components for a particular snowplow vehicle application. The information published in this guide is based on Federal Motor Vehicle Safety Standards (FMVSS) and a "representative" snowplow vehicle as defined in this guide. The vehicle includes a combined weight of 300 lb for occupants in the front seat location.

This *SL* is for specific model year vehicles only and is listed on the front cover of this guide. This guide should be saved for future reference. New selection guides will be published for the upcoming model year and so on. The instructions on page 4 explain how to use the *Selection List*.

The "Representative Vehicle"

Knowing that today's snowplow vehicles come in a variety of sizes and configurations (such as wheel base, engine size, and handling packages), Western Products has defined a "representative vehicle" that contains the options most likely to appear on a typical snowplow application. The "representative vehicle" includes the following options:

- 4X4 Drivetrain (unless noted)
- Spare Tire & Wheel
- Automatic Transmission
- Rear Bumper
- Air Conditioning
- Full Fluids

NOTE: If the vehicle in question does not match a vehicle listing in the *Selection List*, or has options that differ from the "Representative Vehicle" as defined earlier, the ballast inquiry sheet must be filled out and submitted in order to determine plow availability and correct ballast amounts to maintain FMVSS compliance. Completed vehicle at no time shall exceed GVWR or GAWR.

Snowplow Product

Snowplows are considered motor vehicle equipment. The installer is ultimately responsible for determining and correctly labeling the vehicle with the addition of snowplow selection. No product selected and installed shall render inoperative the vehicle's safety compliance.

Product Changes

All information is as accurate as we can determine but is subject to revision with additional or more complete information. Western Products reserves the right under its product improvement policy to change construction or design details and furnish equipment when so altered without reference to illustrations or specifications used. Western Products or the vehicle manufacturer may require or recommend optional equipment for snow removal.

Ballast

When ballast is required it must be secured behind the rear wheels in a manner which prevents it from sliding during normal driving. Ballast shall not exceed 1000 lb.

Western Products offers an optional ballast retainer kit (62849) for this purpose.

HOW TO USE THE SELECTION LIST

Selection Example:

Acme Motors 15000 VX with UltraMount® System

- Go to the section for the appropriate manufacturer.
- Go to the subsection for the desired snowplow:
 - **Section 1:** Suburbanite™ & MIDWEIGHT™ snowplows
 - **Section 2:** PRO-PLOW®, PRO PLUS® & Heavy Weight snowplows
 - **Section 3:** MVP® & MVP PLUS™ snowplows
- Starting at the left-most column, find the **model** and appropriate configuration for the vehicle. In this case, 4X4, Regular Cab, 6.5 ft. box, 5.3L V8 engine, 3925 Min. FGAWR.

- Locate the **harness kit** part number for this vehicle: 27780. See Headlamp Reference Guide in the back of the Selection List for more information.
- Locate the **mount** for this vehicle: 1523 for Suburbanite™ system or 67960-1 for UltraMount® system. Refer to any footnotes concerning conditions or requirements. For this example the UltraMount system is selected and has five footnotes: 1, 2, 3, 4 and 6.
- Locate the acceptable **blades** at the top of the table. Only those blades with ballast weights listed are valid applications. Three short dashes (—) indicates an invalid application. A question mark (?) indicates a ballast inquiry sheet must be completed.

- For this example, there are two acceptable UltraMount blades. Choose the 7'-6" Steel MIDWEIGHT blade. This blade requires 350 lb of ballast.
- To order components for a complete snowplow package, read down from the top of the selected blade column for appropriate part numbers. Be sure to select *one* control, either joystick or hand-held. For this example, the part numbers would be:
 - 64340 (blade assembly)
 - 64336 (A, Q & L assembly Box 1)
 - 67992 (A, Q & L assembly Box 2)
 - 64620 (hydraulic kit)
 - 28800 (light kit)
 - 56369 or 56462 (control)
 - 27780 (harness kit, from Step 4)
 - 67960-1 (mount, from Step 5 – *must match blade*)

2004 Acme Motors

Section 1 Suburbanite™ & MIDWEIGHT™ blades

Model	Body Style	DRW	Box Option	Engine Type	Min FGAWR	Min RGAWR	Min GVWR	Harness Kit	Personal Plow system		Ballast Guidelines, lbs (1)	UltraMount® system		Ballast Guidelines, lbs (1)			
									Mount Kit	Notes		Mount Kit	Notes				
15000 RS	4x4	Reg Cab	No	6.5 Box	4.3L V6	3925	3750	6400	HB3/HB4 use	1523	3,6,8	---	100	67960-1	2,3,4,6	350	300
15000 TU	4x4	Reg Cab	No	6.5 Box	4.8L V8	3925	3750	6400		1523	3,6,8	---	150	67960-1	2,3,4,6	400	400
15000 VX	4x4	Reg Cab	No	6.5 Box	5.3L V8	3925	3750	6400		1523	3,6,8	---	100	67960-1	2,3,4,6	350	350

Suburbanite™		
6'-8" POLY	7'-4" POLY	
SUB68	SUB74	
Blade Assembly	27546	27548
AQ&L Assembly Box 1	27550	
AQ&L Assembly Box 2	n/a	
Hydraulic Kit	27516	
Light Kit	64100	
Choose a Joystick Control or Hand-Held Control	56369	
	56462	

UltraMount™		
MIDWEIGHT™		
7'-6" STEEL	7'-6" POLY	
IUTH75	IUTHY75	
Blade Assembly	64340	64330
AQ&L Assembly Box 1	64336	
AQ&L Assembly Box 2	67992	
Hydraulic Kit	64620	
Light Kit	28800	
Choose a Joystick Control or Hand-Held Control	56369	
	56462	

- Notes:**
- Ballast amounts are based on a "Representative Vehicle," defined in the vehicle selection guide instructions, and must be modified for all other configurations for axle and GVWR compliance.
 - Recommended snowplow prep package whenever available.
 - Requires bumper notching.

- Recommended Z85 suspension.
- All New Style Only (2nd # in model # is 5 not 0) example: K15903. Refer to label in glove box for model number.
- These Snowplows Are For Personal/Homeowner Use Only.

2004 Chevy/GMC

Section 1 Suburbanite™ & MIDWEIGHT™ Blades

 Suburbanite™	
6'-8" POLY SUB68	7'-4" POLY SUB74
Plow Blade Assembly AQ&L Assembly Box 1 AQ&L Assembly Box 2 Hydraulic Kit Light Kit Choose a Joystick Control or Hand-Held Control	
27546	27548
27550	
n/a	
27516	
64100	
56369	
56462	

 UltraMount™	
MIDWEIGHT™	
7'-6" STEEL IUTH75	7'-6" POLY IUTHY75
64340	64330
64336	
67992	
64620	
28800	
56369	
56462	

Model	Body Style	DRW	Box Option	Engine Type	Min F G A W R	Min R G A W R	Min G V W R	Harness Kit	Personal Plow system		Ballast Guidelines, lbs (1)	UltraMount® system		Ballast Guidelines, lbs (1)			
									Mount Kit	Notes		Mount Kit	Notes				
TRAILBLAZER EXT/ENVOY XL	4x4	SU-4DR	No	---	4.2L I6	3200	3400	6400	HB3/HB4 use 28028	1533-1	8	0	0	n/a	---	---	---
TRAILBLAZER EXT/ENVOY XL	4x4	SU-4DR	No	---	5.3L V8	3200	3400	6400	HB3/HB4 use 27480	1533-1	8	0	0	n/a	---	---	---
BLAZER	4x4	SU-4DR	No	---	4.3L V6	2800	2700	5350	HB3/HB4 use 27480	1503	8,16	0	0	n/a	---	---	---
AVALANCHE 1500	4x4	---	No	---	5.3L V8	3800	4000	7000	HB3/HB4 use 27480-1	1523	3,6,8	---	0	67960-1	2,3,4,6	350	300
TAHOE/YUKON 1500	4x4	SU-4DR	No	---	4.8L V8	4180	6000	6900	HB3/HB4 use 27480-1	1523	3,6,8	---	0	67960-1	2,3,4,6	0	0
TAHOE/YUKON 1500	4x4	SU-4DR	No	---	4.8L V8	4180	6000	6800	HB3/HB4 use 27480-1	1523	3,6,8	---	0	67960-1	2,3,4,6	0	0
TAHOE/YUKON 1500	4x4	SU-4DR	No	---	4.8L V8	3800	4000	6900	HB3/HB4 use 27480-1	1523	3,6,8	---	0	67960-1	2,3,4,6	0	0
TAHOE/YUKON 1500	4x4	SU-4DR	No	---	4.8L V8	3400	4000	6800	HB3/HB4 use 27480-1	1523	3,6,8	---	0	67960-1	2,3,4,6	---	---
TAHOE/YUKON 1500	4x4	SU-4DR	No	---	5.3L V8	4180	6000	6900	HB3/HB4 use 27480-1	1523	3,6,8	---	0	67960-1	2,3,4,6	0	0
TAHOE/YUKON 1500	4x4	SU-4DR	No	---	5.3L V8	4180	6000	6800	HB3/HB4 use 27480-1	1523	3,6,8	---	0	67960-1	2,3,4,6	0	0
TAHOE/YUKON 1500	4x4	SU-4DR	No	---	5.3L V8	3800	4000	6900	HB3/HB4 use 27480-1	1523	3,6,8	---	0	67960-1	2,3,4,6	0	0
TAHOE/YUKON 1500	4x4	SU-4DR	No	---	5.3L V8	3400	4000	6800	HB3/HB4 use 27480-1	1523	3,6,8	---	0	67960-1	2,3,4,6	---	---
YUKON DENALI	AWD	SU-4DR	No	---	6.0L V8	3350	4000	7000	HB3/HB4 use 27780	1523	3,6,8	---	0	67960-1	2,3,4,6	---	---
YUKON XL DENALI	AWD	SU-4DR	No	---	6.0L V8	3600	4000	7200	HB3/HB4 use 27780	1523	3,6,8	---	0	67960-1	2,3,4,6	---	---
SUBURBAN/YUKON XL 1500	4x4	SU-4DR	No	---	5.3L V8	3600	4000	7200	HB3/HB4 use 27780	1523	3,6,8	---	0	67960-1	2,3,4,6	---	---
SUBURBAN/YUKON XL 1500	4x4	SU-4DR	No	---	5.3L BIF	3600	4000	7200	HB3/HB4 use 27780	1523	3,6,8	---	0	67960-1	2,3,4,6	---	---
AVALANCHE 2500	4x4	---	No	---	8.1L V8	4500	5500	8600	HB3/HB4 use 27780-2	n/a	---	---	---	67981-2	---	150	100
AVALANCHE 2500	4x4	---	No	---	8.1L V8	4380	5500	8600	HB3/HB4 use 27780-2	n/a	---	---	---	67981-2	---	550	500
SUBURBAN/YUKON XL 2500 w/4WS	4x4	SU-4DR	No	---	6.0L V8	4500	5360	8600	HB3/HB4 use 27780-2	n/a	---	---	---	67981-2	---	0	0
SUBURBAN/YUKON XL 2500 w/4WS	4x4	SU-4DR	No	---	6.0L V8	4180	5360	8600	HB3/HB4 use 27780-2	n/a	---	---	---	67981-2	---	0	0
SUBURBAN/YUKON XL 2500 w/4WS	4x4	SU-4DR	No	---	6.0L V8	4100	5360	8600	HB3/HB4 use 27780-2	n/a	---	---	---	67981-2	---	150	100
SUBURBAN/YUKON XL 2500 w/4WS	4x4	SU-4DR	No	---	8.1L V8	4500	5360	8600	HB3/HB4 use 27780-2	n/a	---	---	---	67981-2	---	0	0
SUBURBAN/YUKON XL 2500	4x4	SU-4DR	No	---	6.0L V8	4500	5360	8600	HB3/HB4 use 27780-2	n/a	---	---	---	67981-2	---	0	0
SUBURBAN/YUKON XL 2500	4x4	SU-4DR	No	---	6.0L V8	4180	5360	8600	HB3/HB4 use 27780-2	n/a	---	---	---	67981-2	---	0	0
SUBURBAN/YUKON XL 2500	4x4	SU-4DR	No	---	6.0L V8	4100	5360	8600	HB3/HB4 use 27780-2	n/a	---	---	---	67981-2	---	100	100
SUBURBAN/YUKON XL 2500	4x4	SU-4DR	No	---	8.1L V8	4500	5360	8600	HB3/HB4 use 27780-2	n/a	---	---	---	67981-2	---	0	0
COLORADO/CANYON Z71	4x4	Reg Cab	No	6.1 Box	2.8L I4	2800	2700	5150	HB3/HB4 use 27480-1	31543	3,8	50	50	n/a	---	---	---
COLORADO/CANYON Z71	4x4	Reg Cab	No	6.1 Box	2.8L I4	2753	2896	5150	HB3/HB4 use 27480-1	31543	3,8	50	50	n/a	---	---	---
COLORADO/CANYON Z71	4x4	Reg Cab	No	6.1 Box	3.5L I5	2800	2700	5150	HB3/HB4 use 27480-1	31543	3,8	50	100	n/a	---	---	---
COLORADO/CANYON Z71	4x4	Reg Cab	No	6.1 Box	3.5L I5	2753	2896	5150	HB3/HB4 use 27480-1	31543	3,8	50	100	n/a	---	---	---
COLORADO/CANYON Z71	4x4	Ext Cab	No	6.1 Box	2.8L I4	2753	2896	5300	HB3/HB4 Canada use 8437-1 & 28555	31543	3,8	50	100	n/a	---	---	---
COLORADO/CANYON Z71	4x4	Ext Cab	No	6.1 Box	2.8L I4	2700	2900	5300	HB3/HB4 Canada use 8437-1 & 28555	31543	3,8	150	250	n/a	---	---	---
COLORADO/CANYON Z71	4x4	Ext Cab	No	6.1 Box	3.5L I5	2753	2896	5300	HB3/HB4 Canada use 8437-1 & 28555	31543	3,8	100	200	n/a	---	---	---
COLORADO/CANYON Z71	4x4	Ext Cab	No	6.1 Box	3.5L I5	2700	2900	5300	HB3/HB4 Canada use 8437-1 & 28555	31543	3,8	300	400	n/a	---	---	---

- Notes:**
- Ballast amounts are based on a "Representative Vehicle," defined in the vehicle selection guide instructions, and must be modified for all other configurations for axle and GVWR compliance.
 - Recommended snowplow prep package whenever available.
 - Requires bumper notching.

- Recommended Z85 suspension.
- All New Style Only (2nd # in model # is 5 not 0) example: K15903. Refer to label in glove box for model number.
- These Snowplows Are For Personal/Homeowner Use Only.
- Not intended for use with High Rider or ZR2 style trucks.

2004 Chevy/GMC

Section 1 Suburbanite™ & MIDWEIGHT™ Blades

 Suburbanite™	
6'-8" POLY	7'-4" POLY
SUB68	SUB74
Plow Blade Assembly	27546
AQ&L Assembly Box 1	27550
AQ&L Assembly Box 2	n/a
Hydraulic Kit	27516
Light Kit	64100
Choose a Joystick Control or Hand-Held Control	56369
	56462

 UltraMount™	
MIDWEIGHT™	
7'-6" STEEL	7'-6" POLY
IUTH75	IUTHY75
64340	64330
64336	
67992	
64620	
28800	
56369	
56462	

Model	Body Style	DRW	Box Option	Engine Type	Min F G A W R	Min R G A W R	Min G V W R	Harness Kit	Personal Plow system		Ballast Guidelines, lbs (1)	UltraMount® system		Ballast Guidelines, lbs (1)			
									Mount Kit	Notes		Mount Kit	Notes				
COLORADO/CANYON Z71	4x4	Crew Cab	No	5.0 Box	2.8L I4	2753	2896	5300	HB3/HB4 US use 27480-1 or HB3/HB4 Canada use 8437-1 & 28555	31543	3,8	0	50	n/a	---	---	---
COLORADO/CANYON Z71	4x4	Crew Cab	No	5.0 Box	2.8L I4	2700	2900	5300		31543	3,8	150	250	n/a	---	---	---
COLORADO/CANYON Z71	4x4	Crew Cab	No	5.0 Box	3.5L I5	2753	2896	5300		31543	3,8	200	300	n/a	---	---	---
COLORADO/CANYON Z71	4x4	Crew Cab	No	5.0 Box	3.5L I5	2700	2900	5300		31543	3,8	400	500	n/a	---	---	---
COLORADO/CANYON Z85	4x4	Reg Cab	No	6.1 Box	2.8L I4	2800	2700	5150		31543	3,8	50	50	n/a	---	---	---
COLORADO/CANYON Z85	4x4	Reg Cab	No	6.1 Box	2.8L I4	2753	2896	5150		31543	3,8	50	50	n/a	---	---	---
COLORADO/CANYON Z85	4x4	Reg Cab	No	6.1 Box	3.5L I5	2800	2700	5150		31543	3,8	50	100	n/a	---	---	---
COLORADO/CANYON Z85	4x4	Reg Cab	No	6.1 Box	3.5L I5	2753	2896	5150		31543	3,8	50	100	n/a	---	---	---
COLORADO/CANYON Z85	4x4	Ext Cab	No	6.1 Box	2.8L I4	2753	2896	5300	HB3/HB4 US use 27480-1 or HB3/HB4 Canada use 8437-1 & 28555	31543	3,8	50	50	n/a	---	---	---
COLORADO/CANYON Z85	4x4	Ext Cab	No	6.1 Box	2.8L I4	2700	2900	5300		31543	3,8	100	200	n/a	---	---	---
COLORADO/CANYON Z85	4x4	Ext Cab	No	6.1 Box	3.5L I5	2753	2896	5300		31543	3,8	100	200	n/a	---	---	---
COLORADO/CANYON Z85	4x4	Ext Cab	No	6.1 Box	3.5L I5	2700	2900	5300		31543	3,8	300	400	n/a	---	---	---
COLORADO/CANYON Z85	4x4	Crew Cab	No	5.0 Box	2.8L I4	2753	2896	5300		31543	3,8	0	50	n/a	---	---	---
COLORADO/CANYON Z85	4x4	Crew Cab	No	5.0 Box	2.8L I4	2700	2900	5300		31543	3,8	150	250	n/a	---	---	---
COLORADO/CANYON Z85	4x4	Crew Cab	No	5.0 Box	3.5L I5	2753	2896	5300		31543	3,8	200	300	n/a	---	---	---
COLORADO/CANYON Z85	4x4	Crew Cab	No	5.0 Box	3.5L I5	2700	2900	5300		31543	3,8	400	500	n/a	---	---	---
K1500 SILV/SIERRA	4x4	Reg Cab	No	6.5 Box	4.3L V6	3925	3750	6400		1523	3,6,8	---	100	67960-1	2,3,4,6	350	350
K1500 SILV/SIERRA	4x4	Reg Cab	No	6.5 Box	4.3L V6	3200	3400	6400		1523	3,6,8	---	100	67960-1	2,3,4,6	---	---
K1500 SILV/SIERRA	4x4	Reg Cab	No	6.5 Box	4.3L V6	3150	3686	6400		1523	3,6,8	---	250	67960-1	2,3,4,6	---	---
K1500 SILV/SIERRA	4x4	Reg Cab	No	6.5 Box	4.8L V8	3925	3750	6400		1523	3,6,8	---	150	67960-1	2,3,4,6	400	350
K1500 SILV/SIERRA	4x4	Reg Cab	No	6.5 Box	4.8L V8	3200	3400	6400		1523	3,6,8	---	400	67960-1	2,3,4,6	---	---
K1500 SILV/SIERRA	4x4	Reg Cab	No	6.5 Box	4.8L V8	3150	3686	6400		1523	3,6,8	---	600	67960-1	2,3,4,6	---	---
K1500 SILV/SIERRA	4x4	Reg Cab	No	6.5 Box	5.3L V8	3925	3750	6400		1523	3,6,8	---	150	67960-1	2,3,4,6	400	350
K1500 SILV/SIERRA	4x4	Reg Cab	No	6.5 Box	5.3L V8	3200	3400	6400	HB3/HB4 use 27780	1523	3,6,8	---	400	67960-1	2,3,4,6	---	---
K1500 SILV/SIERRA	4x4	Reg Cab	No	6.5 Box	5.3L V8	3150	3686	6400		1523	3,6,8	---	600	67960-1	2,3,4,6	---	---
K1500 SILV/SIERRA	4x4	Reg Cab	No	8.0 Box	4.3L V6	3925	3750	6400		1523	3,6,8	---	150	67960-1	2,3,4,6	350	350
K1500 SILV/SIERRA	4x4	Reg Cab	No	8.0 Box	4.3L V6	3200	3400	6400		1523	3,6,8	---	350	67960-1	2,3,4,6	---	---
K1500 SILV/SIERRA	4x4	Reg Cab	No	8.0 Box	4.8L V8	3925	3750	6400		1523	3,6,8	---	150	67960-1	2,3,4,6	400	400
K1500 SILV/SIERRA	4x4	Reg Cab	No	8.0 Box	4.8L V8	3200	3400	6400		1523	3,6,8	---	700	67960-1	2,3,4,6	---	---
K1500 SILV/SIERRA	4x4	Reg Cab	No	8.0 Box	5.3L V8	3925	3750	6400		1523	3,6,8	---	150	67960-1	2,3,4,6	400	400
K1500 SILV/SIERRA	4x4	Reg Cab	No	8.0 Box	5.3L V8	3200	3400	6400		1523	3,6,8	---	700	67960-1	2,3,4,6	---	---

- Notes:**
- Ballast amounts are based on a "Representative Vehicle," defined in the vehicle selection guide instructions, and must be modified for all other configurations for axle and GVWR compliance.
 - Recommended snowplow prep package whenever available.
 - Requires bumper notching.

- Recommended Z85 suspension.
- All New Style Only (2nd # in model # is 5 not 0) example: K15903. Refer to label in glove box for model number.
- These Snowplows Are For Personal/Homeowner Use Only.

2004 Chevy/GMC

Section 1 Suburbanite™ & MIDWEIGHT™ Blades

 Suburbanite™	
6'-8" POLY SUB68	7'-4" POLY SUB74
Plow Blade Assembly AQ&L Assembly Box 1 AQ&L Assembly Box 2 Hydraulic Kit Light Kit Choose a Joystick Control or Hand-Held Control	
27546	27548
27550	
n/a	
27516	
64100	
56369	
56462	

 UltraMount™	
MIDWEIGHT™	
7'-6" STEEL IUTH75	7'-6" POLY IUTHY75
64340	64330
64336	
67992	
64620	
28800	
56369	
56462	

Model	Body Style	DRW	Box Option	Engine Type	Min F G A W R	Min R G A W R	Min G V W R	Harness Kit	Personal Plow system		Ballast Guidelines, lbs (1)	UltraMount® system		Ballast Guidelines, lbs (1)		
									Mount Kit	Notes		Mount Kit	Notes			
K1500 SILV/SIERRA	4x4	Ext Cab	No	6.5 Box	4.8L V8	4180	6000	6900	1523	3,6,8	---	150	67960-1	2,3,4,6	400	400
K1500 SILV/SIERRA	4x4	Ext Cab	No	6.5 Box	4.8L V8	3925	3750	6400	1523	3,6,8	---	150	67960-1	2,3,4,6	400	400
K1500 SILV/SIERRA	4x4	Ext Cab	No	6.5 Box	4.8L V8	3800	4000	6900	1523	3,6,8	---	150	67960-1	2,3,4,6	500	450
K1500 SILV/SIERRA	4x4	Ext Cab	No	6.5 Box	5.3L V8	4180	6000	6900	1523	3,6,8	---	150	67960-1	2,3,4,6	400	400
K1500 SILV/SIERRA	4x4	Ext Cab	No	6.5 Box	5.3L V8	3925	3750	6400	1523	3,6,8	---	150	67960-1	2,3,4,6	400	400
K1500 SILV/SIERRA	4x4	Ext Cab	No	6.5 Box	5.3L V8	3800	4000	6900	1523	3,6,8	---	150	67960-1	2,3,4,6	500	450
K1500 SILV/SIERRA	4x4	Ext Cab	No	8.0 Box	4.8L V8	3925	3750	6400	1523	3,6,8	---	150	67960-1	2,3,4,6	400	350
K1500 SILV/SIERRA	4x4	Ext Cab	No	8.0 Box	5.3L V8	3925	3750	6400	1523	3,6,8	---	150	67960-1	2,3,4,6	400	400
K1500 SILV/SIERRA w/4WS	4x4	Ext Cab	No	6.5 Box	4.8L V8	4180	6000	6900	1523	3,6,8	---	0	67960-1	2,3,4,6	150	150
K1500 SILV/SIERRA w/4WS	4x4	Ext Cab	No	6.5 Box	4.8L V8	3800	4000	6900	1523	3,6,8	---	0	67960-1	2,3,4,6	550	500
K1500 SILV/SIERRA w/4WS	4x4	Ext Cab	No	6.5 Box	5.3L V8	4180	6000	6900	1523	3,6,8	---	0	67960-1	2,3,4,6	150	150
K1500 SILV/SIERRA w/4WS	4x4	Ext Cab	No	6.5 Box	5.3L V8	3800	4000	6900	1523	3,6,8	---	0	67960-1	2,3,4,6	550	500
SIERRA DENALI w/4WS	4x4	Ext Cab	No	---	6.0L V8	3925	4000	7200	1523	3,6,8	---	0	67960-1	2,3,4,6	150	150
SIERRA DENALI w/4WS	4x4	Ext Cab	No	---	6.0L V8	3600	4000	7200	1523	3,6,8	---	150	67960-1	2,3,4,6	---	---
SIERRA DENALI	4x4	Ext Cab	No	---	6.0L V8	3925	4000	7200	1523	3,6,8	---	150	67960-1	2,3,4,6	400	350
SIERRA DENALI	4x4	Ext Cab	No	---	6.0L V8	3600	4000	7200	1523	3,6,8	---	150	67960-1	2,3,4,6	---	---
K2500 SILV/SIERRA	4x4	Ext Cab	No	6.5 Box	6.0L V8	4410	6000	8600	n/a	---	---	---	67981-2	---	350	350
K2500 SILV/SIERRA	4x4	Crew Cab	No	6.5 Box	6.0L V8	4500	6000	8600	n/a	---	---	---	67981-2	---	300	300
K2500 SILV/SIERRA	4x4	Crew Cab	No	6.5 Box	6.0L V8	4410	6000	8600	n/a	---	---	---	67981-2	---	300	300
K2500 SILV/SIERRA w/4WS	4x4	Crew Cab	No	6.5 Box	6.0L V8	4500	6000	8600	n/a	---	---	---	67981-2	---	100	100
K2500 SILV/SIERRA w/4WS	4x4	Crew Cab	No	6.5 Box	6.0L V8	4410	6000	8600	n/a	---	---	---	67981-2	---	100	100
K2500HD SILV/SIERRA	4x4	Reg Cab	No	8.0 Box	6.0L V8	4800	6084	9200	n/a	---	---	---	67981-2	---	250	200
K2500HD SILV/SIERRA	4x4	Reg Cab	No	8.0 Box	6.0L V8	4670	6084	9200	n/a	---	---	---	67981-2	---	250	200
K2500HD SILV/SIERRA	4x4	Reg Cab	No	8.0 Box	6.0L V8	4500	6084	9200	n/a	---	---	---	67981-2	---	250	200
K2500HD SILV/SIERRA	4x4	Reg Cab	No	8.0 Box	6.6L D	4800	6084	9200	n/a	---	---	---	67981-2	---	400	400
K2500HD SILV/SIERRA	4x4	Reg Cab	No	8.0 Box	6.6L D	4670	6084	9200	n/a	---	---	---	67981-2	---	400	400
K2500HD SILV/SIERRA	4x4	Reg Cab	No	8.0 Box	6.6L D	4500	6084	9200	n/a	---	---	---	67981-2	---	550	500
K2500HD SILV/SIERRA	4x4	Reg Cab	No	8.0 Box	6.6L D	4410	6084	9200	n/a	---	---	---	67981-2	---	900	850
K2500HD SILV/SIERRA	4x4	Reg Cab	No	8.0 Box	8.1L V8	4800	6084	9200	n/a	---	---	---	67981-2	---	300	300
K2500HD SILV/SIERRA	4x4	Reg Cab	No	8.0 Box	8.1L V8	4670	6084	9200	n/a	---	---	---	67981-2	---	300	300
K2500HD SILV/SIERRA	4x4	Reg Cab	No	8.0 Box	8.1L V8	4500	6084	9200	n/a	---	---	---	67981-2	---	300	300
K2500HD SILV/SIERRA	4x4	Reg Cab	No	8.0 Box	8.1L V8	4410	6084	9200	n/a	---	---	---	67981-2	---	300	300

HB3/HB4 use
27780

- Notes:**
- Ballast amounts are based on a "Representative Vehicle," defined in the vehicle selection guide instructions, and must be modified for all other configurations for axle and GVWR compliance.
 - Recommended snowplow prep package whenever available.
 - Requires bumper notching.
 - Recommended Z85 suspension.
 - All New Style Only (2nd # in model # is 5 not 0) example: K15903. Refer to label in glove box for model number.
 - These Snowplows Are For Personal/Homeowner Use Only.

2004 Chevy/GMC

Section 1 Suburbanite™ & MIDWEIGHT™ Blades

 Suburbanite™	
6'-8" POLY SUB68	7'-4" POLY SUB74
Plow Blade Assembly AQ&L Assembly Box 1 AQ&L Assembly Box 2 Hydraulic Kit Light Kit Choose a Joystick Control or Hand-Held Control	
27546	27548
27550	
n/a	
27516	
64100	
56369	
56462	

 UltraMount™	
MIDWEIGHT™	
7'-6" STEEL IUTH75	7'-6" POLY IUTHY75
64340	64330
64336	
67992	
64620	
28800	
56369	
56462	

Model	Body Style	DRW	Box Option	Engine Type	Min F G A W R	Min R G A W R	Min G V W R	Harness Kit	Personal Plow system		Ballast Guidelines, lbs (1)	UltraMount® system		Ballast Guidelines, lbs (1)		
									Mount Kit	Notes		Mount Kit	Notes			
K2500HD SILV/SIERRA	4x4	Ext Cab	No	6.5 Box	6.0L V8	4800	6084	9200	n/a	---	---	---	67981-2	---	300	300
K2500HD SILV/SIERRA	4x4	Ext Cab	No	6.5 Box	6.0L V8	4670	6084	9200	n/a	---	---	---	67981-2	---	300	300
K2500HD SILV/SIERRA	4x4	Ext Cab	No	6.5 Box	6.0L V8	4500	6084	9200	n/a	---	---	---	67981-2	---	300	300
K2500HD SILV/SIERRA	4x4	Ext Cab	No	6.5 Box	6.6L D	4800	6084	9200	n/a	---	---	---	67981-2	---	450	450
K2500HD SILV/SIERRA	4x4	Ext Cab	No	6.5 Box	6.6L D	4670	6084	9200	n/a	---	---	---	67981-2	---	450	450
K2500HD SILV/SIERRA	4x4	Ext Cab	No	6.5 Box	8.1L V8	4800	6084	9200	n/a	---	---	---	67981-2	---	400	350
K2500HD SILV/SIERRA	4x4	Ext Cab	No	6.5 Box	8.1L V8	4670	6084	9200	n/a	---	---	---	67981-2	---	400	350
K2500HD SILV/SIERRA	4x4	Ext Cab	No	6.5 Box	8.1L V8	4500	6084	9200	n/a	---	---	---	67981-2	---	400	350
K2500HD SILV/SIERRA	4x4	Ext Cab	No	8.0 Box	6.0L V8	4800	6084	9200	n/a	---	---	---	67981-2	---	250	250
K2500HD SILV/SIERRA	4x4	Ext Cab	No	8.0 Box	6.0L V8	4670	6084	9200	n/a	---	---	---	67981-2	---	250	250
K2500HD SILV/SIERRA	4x4	Ext Cab	No	8.0 Box	6.6L D	4800	6084	9200	n/a	---	---	---	67981-2	---	400	400
K2500HD SILV/SIERRA	4x4	Ext Cab	No	8.0 Box	6.6L D	4670	6084	9200	n/a	---	---	---	67981-2	---	850	800
K2500HD SILV/SIERRA	4x4	Ext Cab	No	8.0 Box	8.1L V8	4800	6084	9200	n/a	---	---	---	67981-2	---	350	350
K2500HD SILV/SIERRA	4x4	Ext Cab	No	8.0 Box	8.1L V8	4670	6084	9200	n/a	---	---	---	67981-2	---	350	350
K2500HD SILV/SIERRA	4x4	Ext Cab	No	8.0 Box	8.1L V8	4500	6084	9200	n/a	---	---	---	67981-2	---	850	800
K2500HD SILV/SIERRA	4x4	Crew Cab	No	6.5 Box	6.0L V8	4800	6084	9200	n/a	---	---	---	67981-2	---	200	200
K2500HD SILV/SIERRA	4x4	Crew Cab	No	6.5 Box	6.0L V8	4670	6084	9200	n/a	---	---	---	67981-2	---	200	200
K2500HD SILV/SIERRA	4x4	Crew Cab	No	6.5 Box	6.0L V8	4500	6084	9200	n/a	---	---	---	67981-2	---	200	200
K2500HD SILV/SIERRA	4x4	Crew Cab	No	6.5 Box	6.6L D	4800	6084	9200	n/a	---	---	---	67981-2	---	600	550
K2500HD SILV/SIERRA	4x4	Crew Cab	No	6.5 Box	8.1L V8	4800	6084	9200	n/a	---	---	---	67981-2	---	300	250
K2500HD SILV/SIERRA	4x4	Crew Cab	No	6.5 Box	8.1L V8	4670	6084	9200	n/a	---	---	---	67981-2	---	350	300
K2500HD SILV/SIERRA	4x4	Crew Cab	No	8.0 Box	6.0L V8	4800	6084	9200	n/a	---	---	---	67981-2	---	200	200
K2500HD SILV/SIERRA	4x4	Crew Cab	No	8.0 Box	6.0L V8	4670	6084	9200	n/a	---	---	---	67981-2	---	200	200
K2500HD SILV/SIERRA	4x4	Crew Cab	No	8.0 Box	6.0L V8	4500	6084	9200	n/a	---	---	---	67981-2	---	200	200
K2500HD SILV/SIERRA	4x4	Crew Cab	No	8.0 Box	6.0L V8	4410	6084	9200	n/a	---	---	---	67981-2	---	200	200
K2500HD SILV/SIERRA	4x4	Crew Cab	No	8.0 Box	6.6L D	4800	6084	9200	n/a	---	---	---	67981-2	---	900	850
K2500HD SILV/SIERRA	4x4	Crew Cab	No	8.0 Box	8.1L V8	4800	6084	9200	n/a	---	---	---	67981-2	---	300	300
K2500HD SILV/SIERRA	4x4	Crew Cab	No	8.0 Box	8.1L V8	4670	6084	9200	n/a	---	---	---	67981-2	---	700	650
K2500HD SILV/SIERRA	4x4	All	No	Chassis	All	All	All	8501	n/a	---	---	---	67981-2	---	?	?

Notes:
1. Ballast amounts are based on a "Representative Vehicle," defined in the vehicle selection guide instructions, and must be modified for all other configurations for axle and GVWR compliance.

2004 Chevy/GMC

Section 2 PRO-PLOW®, PRO PLUS® & Heavy Weight Blades

UltraMount																			UniMount				
PRO-PLOW®										PRO PLUS®									Heavy Weight				
7'-6" STEEL	7'-6" POLY	8'-0" STEEL	8'-0" POLY	8'-6" STEEL	7'-6" STEEL	8'-0" STEEL	8'-6" STEEL	9'-0" STEEL		9'-0" STEEL	10'-0" STEEL												
IUTP75	IUTP75	IUTP80	IUTP80	IUTP85	IUTPP75	IUTPP80	IUTPP85	IUTPP90		IUHW90	IUHW10												
60381	62400	60390	62450	60308	64750	66980	66974	66901		62301	62302												
67950					66490					62298-1													
67951-2					64999					62299-1													
64588					28800					64400													
64999					28800					28800													
64588					56369					56369													
64999					56462					56462													
Choose a Joystick Control or Hand-Held Control										UniMount® system		Ballast Guidelines, lbs (1)											
Model	Body Style	DRW	Box Option	Engine Type	Min F G A W R	Min R G A W R	Min G V W R	Harness Kit	UltraMount® system	Ballast Guidelines, lbs (1)									UniMount® system	Ballast Guidelines, lbs (1)			
									Mount Kit	Notes								Mount Kit	Notes				
TAHOE/YUKON 1500	4x4	SU-4DR	No	---	4.8L V8	4180	6000	6900	67960-1	2,3,4,6	50	100	50	100	---	---	---	---	---	n/a	---	---	---
TAHOE/YUKON 1500	4x4	SU-4DR	No	---	4.8L V8	4180	6000	6800	67960-1	2,3,4,6	50	100	50	100	---	---	---	---	---	n/a	---	---	---
TAHOE/YUKON 1500	4x4	SU-4DR	No	---	5.3L V8	4180	6000	6900	67960-1	2,3,4,6	50	100	50	100	---	---	---	---	---	n/a	---	---	---
TAHOE/YUKON 1500	4x4	SU-4DR	No	---	5.3L V8	4180	6000	6800	67960-1	2,3,4,6	50	100	50	100	---	---	---	---	---	n/a	---	---	---
AVALANCHE 2500	4x4	---	No	---	8.1L V8	4500	5500	8600	67981-2	---	800	1000	900	---	---	---	---	---	n/a	---	---	---	
SUBURBAN/YUKON XL 2500 w/4WS	4x4	SU-4DR	No	---	6.0L V8	4500	5360	8600	67981-2	---	0	0	0	0	---	---	---	---	---	n/a	---	---	---
SUBURBAN/YUKON XL 2500	4x4	SU-4DR	No	---	6.0L V8	4500	5360	8600	67981-2	---	0	0	0	0	---	---	---	---	---	n/a	---	---	---
K1500 SILV/SIERRA	4x4	Reg Cab	No	6.5 Box	4.3L V6	3925	3750	6400	67960-1	2,3,4,6	450	500	500	500	500	---	---	---	---	n/a	---	---	---
K1500 SILV/SIERRA	4x4	Reg Cab	No	6.5 Box	4.8L V8	3925	3750	6400	67960-1	2,3,4,6	500	550	500	550	550	---	---	---	---	n/a	---	---	---
K1500 SILV/SIERRA	4x4	Reg Cab	No	6.5 Box	5.3L V8	3925	3750	6400	67960-1	2,3,4,6	500	550	500	550	550	---	---	---	---	n/a	---	---	---
K1500 SILV/SIERRA	4x4	Reg Cab	No	8.0 Box	4.3L V6	3925	3750	6400	67960-1	2,3,4,6	450	500	500	500	500	---	---	---	---	n/a	---	---	---
K1500 SILV/SIERRA	4x4	Reg Cab	No	8.0 Box	4.8L V8	3925	3750	6400	67960-1	2,3,4,6	500	550	550	550	550	---	---	---	---	n/a	---	---	---
K1500 SILV/SIERRA	4x4	Reg Cab	No	8.0 Box	5.3L V8	3925	3750	6400	67960-1	2,3,4,6	500	550	550	550	550	---	---	---	---	n/a	---	---	---
K1500 SILV/SIERRA	4x4	Ext Cab	No	6.5 Box	4.8L V8	4180	6000	6900	67960-1	2,3,4,6	500	550	550	550	550	---	---	---	---	n/a	---	---	---
K1500 SILV/SIERRA	4x4	Ext Cab	No	6.5 Box	5.3L V8	4180	6000	6900	67960-1	2,3,4,6	500	550	550	550	550	---	---	---	---	n/a	---	---	---
K1500 SILV/SIERRA w/4WS	4x4	Ext Cab	No	6.5 Box	4.8L V8	4180	6000	6900	67960-1	2,3,4,6	300	300	300	350	300	---	---	---	---	n/a	---	---	---
K1500 SILV/SIERRA w/4WS	4x4	Ext Cab	No	6.5 Box	5.3L V8	4180	6000	6900	67960-1	2,3,4,6	300	300	300	350	300	---	---	---	---	n/a	---	---	---
SIERRA DENALI w/4WS	4x4	Ext Cab	No	---	6.0L V8	3925	4000	7200	67960-1	2,3,4,6	850	---	950	---	---	---	---	---	---	n/a	---	---	---
SIERRA DENALI	4x4	Ext Cab	No	---	6.0L V8	3925	4000	7200	67960-1	2,3,4,6	800	---	900	---	1000	---	---	---	---	n/a	---	---	---

- Notes:
- Ballast amounts are based on a "Representative Vehicle," defined in the vehicle selection guide instructions, and must be modified for all other configurations for axle and GVWR compliance.
 - Recommended snowplow prep package whenever available.

- Requires bumper notching.
- Recommended Z85 suspension.
- All New Style Only (2nd # in model # is 5 not 0) example: K15903. Refer to label in glove box for model number.

2004 Chevy/GMC

Section 2 PRO-PLOW®, PRO PLUS® & Heavy Weight Blades

PRO-PLOW®					PRO PLUS®				
7'-6" STEEL	7'-6" POLY	8'-0" STEEL	8'-0" POLY	8'-6" STEEL	7'-6" STEEL	8'-0" STEEL	8'-6" STEEL	9'-0" STEEL	
IUTP75	IUTP75	IUTP80	IUTPY80	IUTP85	IUTPP75	IUTPP80	IUTPP85	IUTPP90	
Blade Assembly	60381	62400	60390	62450	60308	64750	66980	66974	66901
AQ&L Assembly Box 1	67950			66490					
AQ&L Assembly Box 2	67951-2				64999				
Hydraulic Kit	64588			64999					
Light Kit	28800								
Choose a Joystick Control	56369								
or Hand-Held Control	56462								

Heavy Weight	
9'-0" STEEL	10'-0" STEEL
IUHW90	IUHW10
62301	62302
62298-1	
62299-1	
64400	
28800	
56369	
56462	

Model	Body Style	DRW	Box Option	Engine Type	Min F G A W R	Min R G A W R	Min G V W R	Harness Kit	UltraMount® system		Ballast Guidelines, lbs (1)								UniMount® system		Ballast Guidelines, lbs (1)		
									Mount Kit	Notes	Mount Kit	Notes	Mount Kit	Notes	Mount Kit	Notes	Mount Kit	Notes					
K2500 SILV/SIERRA	4x4	Ext Cab	No	6.5 Box	6.0L V8	4410	6000	8600	67981-2	---	500	550	500	550	500	800	900	1000	---	n/a	---	---	---
K2500 SILV/SIERRA	4x4	Crew Cab	No	6.5 Box	6.0L V8	4500	6000	8600	67981-2	---	400	600	450	650	550	---	---	---	---	n/a	---	---	---
K2500 SILV/SIERRA	4x4	Crew Cab	No	6.5 Box	6.0L V8	4410	6000	8600	67981-2	---	750	1000	850	---	950	---	---	---	---	n/a	---	---	---
K2500 SILV/SIERRA w/4WS	4x4	Crew Cab	No	6.5 Box	6.0L V8	4500	6000	8600	67981-2	---	400	650	500	700	600	---	---	---	---	n/a	---	---	---
K2500 SILV/SIERRA w/4WS	4x4	Crew Cab	No	6.5 Box	6.0L V8	4410	6000	8600	67981-2	---	800	---	900	---	1000	---	---	---	---	n/a	---	---	---
K2500HD SILV/SIERRA	4x4	Reg Cab	No	8.0 Box	6.0L V8	4800	6084	9200	67981-2	---	350	400	350	400	400	450	500	500	500	n/a	---	---	---
K2500HD SILV/SIERRA	4x4	Reg Cab	No	8.0 Box	6.0L V8	4670	6084	9200	67981-2	---	350	400	350	400	400	450	500	500	500	n/a	---	---	---
K2500HD SILV/SIERRA	4x4	Reg Cab	No	8.0 Box	6.0L V8	4500	6084	9200	67981-2	---	350	400	350	400	400	450	500	500	500	n/a	---	---	---
K2500HD SILV/SIERRA	4x4	Reg Cab	No	8.0 Box	6.0L V8	4410	6084	9200	67981-2	---	350	400	350	400	400	450	500	500	500	n/a	---	---	---
K2500HD SILV/SIERRA	4x4	Reg Cab	No	8.0 Box	6.6L D	4800	6084	9200	67981-2	---	550	550	550	550	550	850	950	1000	---	n/a	---	---	---
K2500HD SILV/SIERRA	4x4	Reg Cab	No	8.0 Box	6.6L D	4670	6084	9200	67981-2	---	650	900	750	900	850	---	---	---	---	n/a	---	---	---
K2500HD SILV/SIERRA	4x4	Reg Cab	No	8.0 Box	8.1L V8	4800	6084	9200	67981-2	---	450	450	450	500	450	550	550	600	600	n/a	---	---	---
K2500HD SILV/SIERRA	4x4	Reg Cab	No	8.0 Box	8.1L V8	4670	6084	9200	67981-2	---	450	450	450	500	450	650	750	850	900	n/a	---	---	---
K2500HD SILV/SIERRA	4x4	Reg Cab	No	8.0 Box	8.1L V8	4500	6084	9200	67981-2	---	600	850	700	850	800	---	---	---	---	n/a	---	---	---
K2500HD SILV/SIERRA	4x4	Reg Cab	No	8.0 Box	8.1L V8	4410	6084	9200	67981-2	---	950	---	1000	---	---	---	---	---	---	n/a	---	---	---
K2500HD SILV/SIERRA	4x4	Ext Cab	No	6.5 Box	6.0L V8	4800	6084	9200	67981-2	---	400	450	450	450	450	550	550	550	600	n/a	---	---	---
K2500HD SILV/SIERRA	4x4	Ext Cab	No	6.5 Box	6.0L V8	4670	6084	9200	67981-2	---	400	450	450	450	450	550	550	550	600	n/a	---	---	---
K2500HD SILV/SIERRA	4x4	Ext Cab	No	6.5 Box	6.0L V8	4500	6084	9200	67981-2	---	400	450	450	450	450	550	550	550	600	n/a	---	---	---
K2500HD SILV/SIERRA	4x4	Ext Cab	No	6.5 Box	6.0L V8	4800	6084	9200	67981-2	---	400	450	450	450	450	550	550	550	600	n/a	---	---	---
K2500HD SILV/SIERRA	4x4	Ext Cab	No	6.5 Box	6.0L V8	4500	6084	9200	67981-2	---	400	450	450	450	450	550	550	550	600	n/a	---	---	---
K2500HD SILV/SIERRA	4x4	Ext Cab	No	6.5 Box	6.0L V8	4670	6084	9200	67981-2	---	500	600	500	650	550	---	---	---	---	n/a	---	---	---
K2500HD SILV/SIERRA	4x4	Ext Cab	No	8.0 Box	6.0L V8	4800	6084	9200	67981-2	---	350	400	400	400	400	500	500	500	500	n/a	---	---	---
K2500HD SILV/SIERRA	4x4	Ext Cab	No	8.0 Box	6.0L V8	4670	6084	9200	67981-2	---	350	400	400	400	400	500	500	500	500	n/a	---	---	---
K2500HD SILV/SIERRA	4x4	Ext Cab	No	8.0 Box	6.0L V8	4500	6084	9200	67981-2	---	350	400	400	400	400	750	850	950	1000	n/a	---	---	---
K2500HD SILV/SIERRA	4x4	Ext Cab	No	8.0 Box	8.1L V8	4800	6084	9200	67981-2	---	450	650	500	700	600	---	---	---	---	n/a	---	---	---
K2500HD SILV/SIERRA	4x4	Ext Cab	No	8.0 Box	8.1L V8	4670	6084	9200	67981-2	---	950	---	---	---	---	---	---	---	---	n/a	---	---	---
K2500HD SILV/SIERRA	4x4	Crew Cab	No	6.5 Box	6.0L V8	4800	6084	9200	67981-2	---	300	350	350	350	350	450	450	450	500	n/a	---	---	---
K2500HD SILV/SIERRA	4x4	Crew Cab	No	6.5 Box	6.0L V8	4670	6084	9200	67981-2	---	300	350	350	350	350	450	450	550	650	n/a	---	---	---
K2500HD SILV/SIERRA	4x4	Crew Cab	No	6.5 Box	6.0L V8	4500	6084	9200	67981-2	---	300	600	450	650	550	---	---	---	---	n/a	---	---	---
K2500HD SILV/SIERRA	4x4	Crew Cab	No	6.5 Box	6.0L V8	4410	6084	9200	67981-2	---	750	1000	850	---	950	---	---	---	---	n/a	---	---	---
K2500HD SILV/SIERRA	4x4	Crew Cab	No	6.5 Box	8.1L V8	4800	6084	9200	67981-2	---	650	900	750	950	850	---	---	---	---	n/a	---	---	---
K2500HD SILV/SIERRA	4x4	Crew Cab	No	8.0 Box	6.0L V8	4800	6084	9200	67981-2	---	300	350	350	350	350	450	450	450	500	n/a	---	---	---
K2500HD SILV/SIERRA	4x4	Crew Cab	No	8.0 Box	6.0L V8	4670	6084	9200	67981-2	---	300	350	350	350	350	650	750	850	950	n/a	---	---	---
K2500HD SILV/SIERRA	4x4	Crew Cab	No	8.0 Box	6.0L V8	4500	6084	9200	67981-2	---	650	900	750	950	850	---	---	---	---	n/a	---	---	---
K2500HD SILV/SIERRA	4x4	Crew Cab	No	8.0 Box	8.1L V8	4800	6084	9200	67981-2	---	950	---	---	---	---	---	---	---	---	n/a	---	---	---
K2500HD SILV/SIERRA	4x4	All	No	Chassis	All	All	All	8501	67981-2	---	?	?	?	?	?	?	?	?	?	n/a	---	---	---

Notes:
1. Ballast amounts are based on a "Representative Vehicle," defined in the vehicle selection guide instructions, and must be modified for all other configurations for axle and GVWR compliance.

2004 Chevy/GMC

Section 2 PRO-PLOW®, PRO PLUS® & Heavy Weight Blades

UltraMount								
PRO-PLOW®					PRO PLUS®			
7'-6" STEEL	7'-6" POLY	8'-0" STEEL	8'-0" POLY	8'-6" STEEL	7'-6" STEEL	8'-0" STEEL	8'-6" STEEL	9'-0" STEEL
IUTP75	IUTPY75	IUTP80	IUTPY80	IUTP85	IUTPP75	IUTPP80	IUTPP85	IUTPP90
60381	62400	60390	62450	60308	64750	66980	66974	66901
67950					66490			
67951-2								
64588					64999			
Light Kit					28800			
Choose a Joystick Control or Hand-Held Control					56369			
					56462			

UniMount	
Heavy Weight	
9'-0" STEEL	10'-0" STEEL
IUHW90	IUHW10
62301	62302
62298-1	
62299-1	
64400	
28800	
56369	
56462	

Model	Body Style	DRW	Box Option	Engine Type	Min FAWR	Min RAWR	Min GVWR	Harness Kit	UltraMount® system		Ballast Guidelines, lbs (1)								UniMount® system		Ballast Guidelines, lbs (1)		
									Mount Kit	Notes	Mount Kit	Notes	Mount Kit	Notes	Mount Kit	Notes	Mount Kit	Notes					
K3500 SILV/SIERRA	4x4	Reg Cab	Yes	8.0 Box	6.0L V8	4800	8550	11400	67981-2	---	---	---	---	---	150	---	---	250	250	n/a	---	---	---
K3500 SILV/SIERRA	4x4	Reg Cab	Yes	8.0 Box	6.0L V8	4670	8550	11400	67981-2	---	---	---	---	---	150	---	---	250	250	n/a	---	---	---
K3500 SILV/SIERRA	4x4	Reg Cab	Yes	8.0 Box	6.0L V8	4500	8550	11400	67981-2	---	---	---	---	---	150	---	---	300	350	n/a	---	---	---
K3500 SILV/SIERRA	4x4	Reg Cab	Yes	8.0 Box	6.6L D	4800	8550	11400	67981-2	---	---	---	---	---	550	---	---	---	---	n/a	---	---	---
K3500 SILV/SIERRA	4x4	Reg Cab	Yes	8.0 Box	6.6L D	4670	8550	11400	67981-2	---	---	---	---	---	950	---	---	---	---	n/a	---	---	---
K3500 SILV/SIERRA	4x4	Reg Cab	Yes	8.0 Box	8.1L V8	4800	8550	11400	67981-2	---	---	---	---	---	250	---	---	550	650	n/a	---	---	---
K3500 SILV/SIERRA	4x4	Reg Cab	Yes	8.0 Box	8.1L V8	4670	8550	11400	67981-2	---	---	---	---	---	400	---	---	1000	---	n/a	---	---	---
K3500 SILV/SIERRA	4x4	Reg Cab	Yes	8.0 Box	8.1L V8	4500	8550	11400	67981-2	---	---	---	---	---	950	---	---	---	---	n/a	---	---	---
K3500 SILV/SIERRA	4x4	Ext Cab	Yes	8.0 Box	6.0L V8	4800	8550	11400	67981-2	---	---	---	---	---	100	---	---	200	200	n/a	---	---	---
K3500 SILV/SIERRA	4x4	Ext Cab	Yes	8.0 Box	8.1L V8	4800	8550	11400	67981-2	---	---	---	---	---	800	---	---	---	---	n/a	---	---	---
K3500 SILV/SIERRA	4x4	Crew Cab	Yes	8.0 Box	6.0L V8	4800	8550	11400	67981-2	---	---	---	---	---	100	---	---	450	550	n/a	---	---	---
K3500 SILV/SIERRA	4x4	All	Yes	Chassis	All	All	All	8501	67981-2	---	---	---	---	---	?	---	---	?	?	n/a	---	---	---
C3500 SILV/SIERRA	4x2	Ext Cab	Yes	8.0 Box	6.0L V8	4800	8550	11400	67981-2	---	---	---	---	---	0	---	---	100	150	n/a	---	---	---
C3500 SILV/SIERRA	4x2	Ext Cab	Yes	8.0 Box	6.0L V8	4670	8550	11400	67981-2	---	---	---	---	---	0	---	---	100	150	n/a	---	---	---
C3500 SILV/SIERRA	4x2	Ext Cab	Yes	8.0 Box	6.6L D	4800	8550	11400	67981-2	---	---	---	---	---	600	---	---	---	---	n/a	---	---	---
C3500 SILV/SIERRA	4x2	Ext Cab	Yes	8.0 Box	8.1L V8	4800	8550	11400	67981-2	---	---	---	---	---	150	---	---	600	700	n/a	---	---	---
C3500 SILV/SIERRA	4x2	Ext Cab	Yes	8.0 Box	8.1L V8	4670	8550	11400	67981-2	---	---	---	---	---	450	---	---	---	---	n/a	---	---	---
C3500 SILV/SIERRA	4x2	Crew Cab	Yes	8.0 Box	6.0L V8	4800	8550	11400	67981-2	---	---	---	---	---	0	---	---	100	100	n/a	---	---	---
C3500 SILV/SIERRA	4x2	Crew Cab	Yes	8.0 Box	6.6L D	4800	8550	11400	67981-2	---	---	---	---	---	900	---	---	---	---	n/a	---	---	---
C3500 SILV/SIERRA	4x2	Crew Cab	Yes	8.0 Box	8.1L V8	4800	8550	11400	67981-2	---	---	---	---	---	200	---	---	900	1000	n/a	---	---	---
C3500 SILV/SIERRA	4x2	Crew Cab	Yes	8.0 Box	8.1L V8	4670	8550	11400	67981-2	---	---	---	---	---	750	---	---	---	---	n/a	---	---	---
C3500 SILV/SIERRA	4x2	All	Yes	Chassis	All	All	All	10001	67981-2	---	---	---	---	---	?	---	---	?	?	n/a	---	---	---
C4500	4x2	All	Yes	Chassis	All	All	All	10001	2B use 27890 or 1A/2A use 27890	64110	2	---	---	---	---	---	---	?	?	62275	---	?	?
C5500	4x2	All	Yes	Chassis	All	All	All	10001	2B use 27890 or 1A/2A use 27890	64110	2	---	---	---	---	---	---	?	?	62275	---	?	?

- Notes:
- Ballast amounts are based on a "Representative Vehicle," defined in the vehicle selection guide instructions, and must be modified for all other configurations for axle and GVWR compliance.
 - Recommended snowplow prep package whenever available.

2004 Chevy/GMC

Section 3 MVP® & MVP PLUS™ Blades

MVP®		MVP PLUS™				
8'-6" STEEL	7'-6" STEEL	7'-6" POLY	8'-6" STEEL	8'-6" POLY	9'-6" STEEL	9'-6" POLY
IUMV85	IUMVPP75	IUMVPPY75	IUMVPP85	IUMVPPY85	IUMVPP95	IUMVPPY95
Blade Assembly	63819	44475	44575	44485	44585	44495
AQ&L Assembly Box 1	63910					
AQ&L Assembly Box 2	67951-2	44225				
Hydraulic Kit	64777					
Light Kit	28800					
Choose a Joystick Control or Hand-Held Control	96369	96700				
	96462	96600				

Model	Body Style	DRW	Box Option	Engine Type	Min FAWR	Min RAWR	Min GVWR	Harness Kit	UltraMount® system		67960-1	2,3,4,6	---	550	550	---	---	---	---
									Mount Kit	Notes									
K1500 SILV/SIERRA	4x4	Reg Cab	No	6.5 Box	4.3L V6	3925	3750	6400		67960-1	2,3,4,6	---	550	550	---	---	---	---	---
K1500 SILV/SIERRA	4x4	Reg Cab	No	6.5 Box	4.8L V8	3925	3750	6400		67960-1	2,3,4,6	---	700	600	---	---	---	---	---
K1500 SILV/SIERRA	4x4	Reg Cab	No	6.5 Box	5.3L V8	3925	3750	6400		67960-1	2,3,4,6	---	700	600	---	---	---	---	---
K1500 SILV/SIERRA	4x4	Reg Cab	No	8.0 Box	4.3L V6	3925	3750	6400		67960-1	2,3,4,6	---	550	550	---	---	---	---	---
K1500 SILV/SIERRA	4x4	Ext Cab	No	6.5 Box	4.8L V8	4180	6000	6900		67960-1	2,3,4,6	---	600	600	---	---	---	---	---
K1500 SILV/SIERRA	4x4	Ext Cab	No	6.5 Box	5.3L V8	4180	6000	6900		67960-1	2,3,4,6	---	600	600	---	---	---	---	---
K2500 SILV/SIERRA	4x4	Ext Cab	No	6.5 Box	6.0L V8	4410	6000	8600		67981-2	---	---	---	800	650	---	950	---	---
K2500 SILV/SIERRA	4x4	Crew Cab	No	6.5 Box	6.0L V8	4500	6000	8600		67981-2	---	---	---	1000	---	---	---	---	---
K2500HD SILV/SIERRA	4x4	Reg Cab	No	8.0 Box	6.0L V8	4800	6084	9200		67981-2	---	550	450	450	500	450	600	550	550
K2500HD SILV/SIERRA	4x4	Reg Cab	No	8.0 Box	6.0L V8	4670	6084	9200		67981-2	---	550	450	450	500	450	600	550	550
K2500HD SILV/SIERRA	4x4	Reg Cab	No	8.0 Box	6.0L V8	4500	6084	9200		67981-2	---	550	450	450	500	450	800	600	600
K2500HD SILV/SIERRA	4x4	Reg Cab	No	8.0 Box	6.0L V8	4410	6084	9200		67981-2	---	700	450	450	500	450	---	---	900
K2500HD SILV/SIERRA	4x4	Reg Cab	No	8.0 Box	6.6L D	4800	6084	9200		67981-2	---	---	850	750	---	950	---	---	---
K2500HD SILV/SIERRA	4x4	Reg Cab	No	8.0 Box	8.1L V8	4800	6084	9200		67981-2	---	700	550	500	600	550	---	---	900
K2500HD SILV/SIERRA	4x4	Reg Cab	No	8.0 Box	8.1L V8	4670	6084	9200	HB3/HB4 use 27780	67981-2	---	---	700	550	950	750	---	---	---
K2500HD SILV/SIERRA	4x4	Ext Cab	No	6.5 Box	6.0L V8	4800	6084	9200		67981-2	---	600	500	500	550	550	700	650	650
K2500HD SILV/SIERRA	4x4	Ext Cab	No	6.5 Box	6.0L V8	4670	6084	9200		67981-2	---	600	500	500	550	550	700	650	650
K2500HD SILV/SIERRA	4x4	Ext Cab	No	6.5 Box	6.0L V8	4500	6084	9200		67981-2	---	900	500	500	650	550	---	---	---
K2500HD SILV/SIERRA	4x4	Ext Cab	No	6.5 Box	8.1L V8	4800	6084	9200		67981-2	---	---	600	600	900	700	---	---	---
K2500HD SILV/SIERRA	4x4	Ext Cab	No	6.5 Box	8.1L V8	4670	6084	9200		67981-2	---	---	---	1000	---	---	---	---	---
K2500HD SILV/SIERRA	4x4	Ext Cab	No	8.0 Box	6.0L V8	4800	6084	9200		67981-2	---	550	450	450	500	500	600	600	600
K2500HD SILV/SIERRA	4x4	Ext Cab	No	8.0 Box	6.0L V8	4670	6084	9200		67981-2	---	600	450	450	500	500	---	---	850
K2500HD SILV/SIERRA	4x4	Ext Cab	No	8.0 Box	6.0L V8	4500	6084	9200		67981-2	---	---	---	800	650	---	900	---	---
K2500HD SILV/SIERRA	4x4	Ext Cab	No	8.0 Box	8.1L V8	4800	6084	9200		67981-2	---	---	---	1000	---	---	---	---	---
K2500HD SILV/SIERRA	4x4	Crew Cab	No	6.5 Box	6.0L V8	4800	6084	9200		67981-2	---	500	450	400	450	450	900	600	600
K2500HD SILV/SIERRA	4x4	Crew Cab	No	6.5 Box	6.0L V8	4670	6084	9200		67981-2	---	950	450	400	700	500	---	---	---
K2500HD SILV/SIERRA	4x4	Crew Cab	No	6.5 Box	6.0L V8	4500	6084	9200		67981-2	---	---	---	1000	---	---	---	---	---
K2500HD SILV/SIERRA	4x4	Crew Cab	No	8.0 Box	6.0L V8	4800	6084	9200		67981-2	---	650	400	400	450	450	---	---	900
K2500HD SILV/SIERRA	4x4	Crew Cab	No	8.0 Box	6.0L V8	4670	6084	9200		67981-2	---	---	700	550	1000	800	---	---	---
K2500HD SILV/SIERRA	4x4	All	No	Chassis	All	All	All	8501		67981-2	---	?	?	?	?	?	?	?	?

- Notes:**
- Ballast amounts are based on a "Representative Vehicle," defined in the vehicle selection guide instructions, and must be modified for all other configurations for axle and GVWR compliance.
 - Recommended snowplow prep package whenever available.

- Requires bumper notching.
- Recommended Z85 suspension.
- All New Style Only (2nd # in model # is 5 not 0) example: K15903. Refer to label in glove box for model number.

2004 Chevy/GMC

Section 3 MVP® & MVP PLUS™ Blades

UltraMount						
MVP®	MVP PLUS™					
8'-6" STEEL	7'-6" STEEL	7'-6" POLY	8'-6" STEEL	8'-6" POLY	9'-6" STEEL	9'-6" POLY
IUMVP85	IUTHVPP75	IUTHVPPY75	IUTHVPP85	IUTHVPPY85	IUTHVPP95	IUTHVPPY95
Blade Assembly	63819	44475	44575	44485	44585	44495
AQ&L Assembly Box 1	63910					
AQ&L Assembly Box 2	67951-2	44225				
Hydraulic Kit	64777					
Light Kit	28800					
Choose a Joystick Control or Hand-Held Control	96369	96700				
	96462	96600				

Model	Body Style	DRW	Box Option	Engine Type	Min F G A W R	Min R G A W R	Min G V W R	Harness Kit	UltraMount® system		Ballast	Ballast	Ballast	Ballast	Ballast	Ballast	
									Mount Kit	Notes							
K3500 SILV/SIERRA	4x4	Reg Cab	Yes	8.0 Box	6.0L V8	4800	8550	11400	67981-2	---	300	---	---	250	200	350	300
K3500 SILV/SIERRA	4x4	Reg Cab	Yes	8.0 Box	6.0L V8	4670	8550	11400	67981-2	---	300	---	---	250	200	400	300
K3500 SILV/SIERRA	4x4	Reg Cab	Yes	8.0 Box	6.0L V8	4500	8550	11400	67981-2	---	600	---	---	400	250	1000	800
K3500 SILV/SIERRA	4x4	Reg Cab	Yes	8.0 Box	8.1L V8	4800	8550	11400	67981-2	---	900	---	---	650	500	---	---
K3500 SILV/SIERRA	4x4	Reg Cab	Yes	8.0 Box	8.1L V8	4670	8550	11400	67981-2	---	---	---	---	---	950	---	---
K3500 SILV/SIERRA	4x4	Ext Cab	Yes	8.0 Box	6.0L V8	4800	8550	11400	67981-2	---	350	---	---	200	150	750	550
K3500 SILV/SIERRA	4x4	Crew Cab	Yes	8.0 Box	6.0L V8	4800	8550	11400	67981-2	---	850	---	---	600	400	---	---
K3500 SILV/SIERRA	4x4	All	Yes	Chassis	All	All	All	8501	67981-2	---	?	---	---	?	?	?	?
C3500 SILV/SIERRA	4x2	Ext Cab	Yes	8.0 Box	6.0L V8	4800	8550	11400	67981-2	---	150	---	---	100	100	200	200
C3500 SILV/SIERRA	4x2	Ext Cab	Yes	8.0 Box	6.0L V8	4670	8550	11400	67981-2	---	150	---	---	100	100	400	200
C3500 SILV/SIERRA	4x2	Ext Cab	Yes	8.0 Box	8.1L V8	4800	8550	11400	67981-2	---	950	---	---	750	550	---	---
C3500 SILV/SIERRA	4x2	Crew Cab	Yes	8.0 Box	6.0L V8	4800	8550	11400	67981-2	---	150	---	---	100	100	200	200
C3500 SILV/SIERRA	4x2	Crew Cab	Yes	8.0 Box	6.0L V8	4670	8550	11400	67981-2	---	200	---	---	100	100	700	450
C3500 SILV/SIERRA	4x2	Crew Cab	Yes	8.0 Box	8.1L V8	4800	8550	11400	67981-2	---	---	---	---	---	900	---	---
C3500 SILV/SIERRA	4x2	All	Yes	Chassis	All	All	All	10001	67981-2	---	?	---	---	?	?	?	?
C4500	4x2	All	Yes	Chassis	All	All	All	10001	2B use 27890 or 1A/2A use 27890	64110	2	?	---	?	?	?	?
C5500	4x2	All	Yes	Chassis	All	All	All	10001	2B use 27890 or 1A/2A use 27890	64110	2	?	---	?	?	?	?

- Notes:**
- Ballast amounts are based on a "Representative Vehicle," defined in the vehicle selection guide instructions, and must be modified for all other configurations for axle and GVWR compliance.
 - Recommended snowplow prep package whenever available.

2004 Dodge

Section 1 Suburbanite™ & MIDWEIGHT™ Blades

 Suburbanite™	
6'-8" POLY	7'-4" POLY
SUB68	SUB74
Blade Assembly	27546 27548
AQ&L Assembly Box 1	27550
AQ&L Assembly Box 2	n/a
Hydraulic Kit	27516
Light Kit	64100
Choose a Joystick Control	56369
or Hand-Held Control	56462

 UltraMount™	
MIDWEIGHT™	
7'-6" STEEL	7'-6" POLY
IUTH75	IUTHY75
64340	64330
64336	
67992	
64620	
28800	
56369	
56462	

Model	4x4	Body Style	DRW	Box Option	Engine Type	Min F G A W R	Min R G A W R	Min G V W R	Harness Kit	Personal Plow system		Ballast Guidelines, lbs (1)	UltraMount® system		Ballast Guidelines, lbs (1)			
										Mount Kit	Notes		Mount Kit	Notes				
DURANGO ST	4x4	SU-4DR	No	---	4.7L V8	3600	3900	6600	H13 use 28400	33903	3,8	---	0	n/a	---	---	---	
DURANGO SLT	4x4	SU-4DR	No	---	4.7L V8	3600	3900	6600		33903	3,8	---	0	n/a	---	---	---	
DURANGO SLT	4x4	SU-4DR	No	---	5.7L V8	3600	3900	6600		33903	3,8	---	0	n/a	---	---	---	
DURANGO LIMITED	4x4	SU-4DR	No	---	4.7L V8	3600	3900	6600		33903	3,8	---	0	n/a	---	---	---	
DURANGO LIMITED	4x4	SU-4DR	No	---	5.7L V8	3600	3900	6600		33903	3,8	---	0	n/a	---	---	---	
DAKOTA	4x4	Reg Cab	No	6.5 Box	3.7L V6	3600	3806	5900	HB5 use 8436	n/a	---	---	---	3919	---	350	300	
DAKOTA	4x4	Reg Cab	No	6.5 Box	3.7L V6	3600	3806	5400		n/a	---	---	---	---	3919	---	350	350
DAKOTA	4x4	Club Cab	No	6.5 Box	3.7L V6	3600	3806	6010		n/a	---	---	---	---	3919	---	300	300
DAKOTA SLT	4x4	Reg Cab	No	6.5 Box	3.7L V6	3600	3806	5900		n/a	---	---	---	---	3919	---	350	300
DAKOTA SLT	4x4	Reg Cab	No	6.5 Box	3.7L V6	3600	3806	5400		n/a	---	---	---	---	3919	---	350	350
DAKOTA SLT	4x4	Reg Cab	No	6.5 Box	4.7L V8	3600	3806	5900		n/a	---	---	---	---	3919	---	350	350
DAKOTA SLT	4x4	Reg Cab	No	6.5 Box	4.7L V8	3600	3806	5400		n/a	---	---	---	---	3919	---	350	350
DAKOTA SLT	4x4	Club Cab	No	6.5 Box	3.7L V6	3600	3806	6010		n/a	---	---	---	---	3919	---	350	350
DAKOTA SLT	4x4	Club Cab	No	6.5 Box	4.7L V8	3600	3806	6010		n/a	---	---	---	---	3919	---	350	350
DAKOTA SLT	4x4	Quad Cab	No	5.3 Box	3.7L V6	3600	3806	6010		n/a	---	---	---	---	3919	---	200	200
DAKOTA SLT	4x4	Quad Cab	No	5.3 Box	4.7L V8	3600	3806	6010		n/a	---	---	---	---	3919	---	250	250
DAKOTA SPORT	4x4	Reg Cab	No	6.5 Box	3.7L V6	3600	3806	5900		n/a	---	---	---	---	3919	---	350	350
DAKOTA SPORT	4x4	Reg Cab	No	6.5 Box	3.7L V6	3600	3806	5400		n/a	---	---	---	---	3919	---	350	350
DAKOTA SPORT	4x4	Reg Cab	No	6.5 Box	4.7L V8	3600	3806	5400		n/a	---	---	---	---	3919	---	350	350
DAKOTA SPORT	4x4	Club Cab	No	6.5 Box	3.7L V6	3600	3806	6010		n/a	---	---	---	---	3919	---	350	350
DAKOTA SPORT	4x4	Club Cab	No	6.5 Box	4.7L V8	3600	3806	6010		n/a	---	---	---	---	3919	---	350	350
DAKOTA SPORT	4x4	Quad Cab	No	5.3 Box	3.7L V6	3600	3806	6010		n/a	---	---	---	---	3919	---	200	200
DAKOTA SPORT	4x4	Quad Cab	No	5.3 Box	4.7L V8	3600	3806	6010		n/a	---	---	---	---	3919	---	250	200

- Notes:**
- Ballast amounts are based on a "Representative Vehicle," defined in the vehicle selection guide instructions, and must be modified for all other configurations for axle and GVWR compliance.
 - Requires bumper notching.
 - These Snowplows Are For Personal/Homeowner Use Only.

2004 Dodge

Section 1 Suburbanite™ & MIDWEIGHT™ Blades

 Suburbanite™	
6'-8" POLY SUB68	7'-4" POLY SUB74
Plow Blade Assembly 27546	27548
AQ&L Assembly Box 1 27550	
AQ&L Assembly Box 2 n/a	
Hydraulic Kit 27516	
Light Kit 64100	
Choose a Joystick Control 56369	
or Hand-Held Control 56462	

 UltraMount™	
MIDWEIGHT™	
7'-6" STEEL IUTH75	7'-6" POLY IUTHY75
64340	64330
64336	
67992	
64620	
28800	
56369	
56462	

Model	Body Style	DRW	Box Option	Engine Type	Min F G A W R	Min R G A W R	Min G V W R	Harness Kit	Personal Plow system		Ballast Guidelines, lbs (1)	UltraMount® system		Ballast Guidelines, lbs (1)	
									Mount Kit	Notes		Mount Kit	Notes		
RAM 1500	4x4	Reg Cab	No	6.5 Box	4.7L FFV	3900	3900	6350	n/a	---	---	63760	3	200	200
RAM 1500	4x4	Reg Cab	No	6.5 Box	4.7L OHC	3900	3900	6350	n/a	---	---	63760	3	200	200
RAM 1500	4x4	Reg Cab	No	6.5 Box	5.7L V8	3900	3900	6350	n/a	---	---	63760	3	200	200
RAM 1500	4x4	Reg Cab	No	8.0 Box	4.7L V8	3900	3900	6550	n/a	---	---	63760	3	350	300
RAM 1500	4x4	Reg Cab	No	8.0 Box	5.7L V8	3900	3900	6550	n/a	---	---	63760	3	300	250
RAM 1500	4x4	Quad Cab	No	6.5 Box	4.7L V8	3900	3900	6650	n/a	---	---	63760	3	400	350
RAM 1500	4x4	Quad Cab	No	6.5 Box	5.7L V8	3900	3900	6650	n/a	---	---	63760	3	350	300
RAM 1500 SLT	4x4	Reg Cab	No	6.5 Box	4.7L V8	3900	3900	6350	n/a	---	---	63760	3	200	200
RAM 1500 SLT	4x4	Reg Cab	No	6.5 Box	5.7L V8	3900	3900	6350	n/a	---	---	63760	3	150	150
RAM 1500 SLT	4x4	Reg Cab	No	8.0 Box	4.7L V8	3900	3900	6550	n/a	---	---	63760	3	400	350
RAM 1500 SLT	4x4	Reg Cab	No	8.0 Box	5.7L V8	3900	3900	6550	n/a	---	---	63760	3	400	350
RAM 1500 SLT	4x4	Quad Cab	No	6.5 Box	5.7L V8	3900	3900	6650	n/a	---	---	63760	3	400	350
RAM 1500 SLT+20" tires	4x4	Reg Cab	No	6.5 Box	4.7L V8	3900	3900	6350	n/a	---	---	63760	3	200	200
RAM 1500 SLT+20" tires	4x4	Reg Cab	No	6.5 Box	5.7L V8	3900	3900	6350	n/a	---	---	63760	3	150	150
RAM 1500 SLT+20" tires	4x4	Quad Cab	No	6.5 Box	5.7L V8	3900	3900	6650	n/a	---	---	63760	3	450	400
RAM 1500 SLT+LT275/70R17 tires	4x4	Reg Cab	No	6.5 Box	4.7L V8	3900	3900	6350	n/a	---	---	63760	3	200	200
RAM 1500 SLT+LT275/70R17 tires	4x4	Reg Cab	No	6.5 Box	5.7L V8	3900	3900	6350	n/a	---	---	63760	3	150	150
RAM 1500 SLT+LT275/70R17 tires	4x4	Quad Cab	No	6.5 Box	5.7L V8	3900	3900	6650	n/a	---	---	63760	3	450	400
RAM 2500	4x4	Reg Cab	No	8.0 Box	5.7L V8	5200	6000	8650	n/a	---	---	63883-2	23	200	200
RAM 2500	4x4	Reg Cab	No	8.0 Box	5.9L D	5200	6000	9000	n/a	---	---	63883-2	23	450	450
RAM 2500	4x4	Reg Cab	No	8.0 Box	5.9L D HO	5200	6000	9000	n/a	---	---	63883-2	23	450	450
RAM 2500	4x4	Quad Cab	No	6.5 Box	5.7L V8	5200	6000	8800	n/a	---	---	63883-2	23	100	100
RAM 2500	4x4	Quad Cab	No	6.5 Box	5.9L D	5200	6000	9000	n/a	---	---	63883-2	23	400	350
RAM 2500	4x4	Quad Cab	No	6.5 Box	5.9L D HO	5200	6000	9000	n/a	---	---	63883-2	23	350	350
RAM 2500	4x4	Quad Cab	No	8.0 Box	5.7L V8	5200	6000	8800	n/a	---	---	63883-2	23	150	150
RAM 2500	4x4	Quad Cab	No	8.0 Box	5.9L D	5200	6000	9000	n/a	---	---	63883-2	23	400	400
RAM 2500	4x4	Quad Cab	No	8.0 Box	5.9L D HO	5200	6000	9000	n/a	---	---	63883-2	23	400	400
RAM 2500	4x4	All	No	Chassis	All	All	All	8501	n/a	---	---	63883-2	23	?	?
RAM 2500 SLT	4x4	Reg Cab	No	8.0 Box	5.7L V8	5200	6000	8650	n/a	---	---	63883-2	23	200	200
RAM 2500 SLT	4x4	Reg Cab	No	8.0 Box	5.9L D	5200	6000	9000	n/a	---	---	63883-2	23	450	450
RAM 2500 SLT	4x4	Reg Cab	No	8.0 Box	5.9L D HO	5200	6000	9000	n/a	---	---	63883-2	23	400	400
RAM 2500 SLT	4x4	Quad Cab	No	6.5 Box	5.7L V8	5200	6000	8800	n/a	---	---	63883-2	23	100	100
RAM 2500 SLT	4x4	Quad Cab	No	6.5 Box	5.9L D	5200	6000	9000	n/a	---	---	63883-2	23	350	350
RAM 2500 SLT	4x4	Quad Cab	No	8.0 Box	5.7L V8	5200	6000	8800	n/a	---	---	63883-2	23	100	100
RAM 2500 SLT	4x4	Quad Cab	No	8.0 Box	5.9L D	5200	6000	9000	n/a	---	---	63883-2	23	400	400
RAM 2500 SLT	4x4	Quad Cab	No	8.0 Box	5.9L D HO	5200	6000	9000	n/a	---	---	63883-2	23	650	600

HB5 use 8436

- Notes:**
- Ballast amounts are based on a "Representative Vehicle," defined in the vehicle selection guide instructions, and must be modified for all other configurations for axle and GVWR compliance.
 - Requires bumper notching.
 - Requires bumper notching on Sport and LE Sport option.

2004 Dodge

Section 2

PRO-PLOW®, PRO PLUS® & Heavy Weight Blades

UltraMount									
PRO-PLOW®					PRO PLUS®				
7'-6" STEEL	7'-6" POLY	8'-0" STEEL	8'-0" POLY	8'-6" STEEL	7'-6" STEEL	8'-0" STEEL	8'-6" STEEL	9'-0" STEEL	
IUTP75	IUTP75	IUTP80	IUTPY80	IUTP85	IUTPP75	IUTPP80	IUTPP85	IUTPP90	
Blade Assembly	60381	62400	60390	62450	60308	64750	66980	66974	66901
AQ&L Assembly Box 1	67950				66490				
AQ&L Assembly Box 2	67951-2								
Hydraulic Kit	64588				64999				
Light Kit					28800				
Choose a Joystick Control or Hand-Held Control					56369				
					56462				

UniMount	
Heavy Weight	
9'-0" STEEL	10'-0" STEEL
IUHW90	IUHW10
62301	62302
62298-1	
62299-1	
64400	
28800	
56369	
56462	

Model	Body Style	DRW	Box Option	Engine Type	Min FAWR	Min R GAWR	Min GVWR	Harness Kit	UltraMount® system		Ballast Guidelines, lbs (1)									UniMount® system		Ballast Guidelines, lbs (1)				
									Mount Kit	Notes	Mount Kit	Notes	Mount Kit	Notes	Mount Kit	Notes	Mount Kit	Notes	Mount Kit	Notes						
DAKOTA	4x4	Reg Cab	No	6.5 Box	3.7L V6	3600	3806	5900			3919	---	450	500	450	500	---	---	---	---	---	---	n/a	---	---	---
DAKOTA	4x4	Club Cab	No	6.5 Box	3.7L V6	3600	3806	6010			3919	---	450	500	450	500	---	---	---	---	---	---	n/a	---	---	---
DAKOTA SLT	4x4	Reg Cab	No	6.5 Box	3.7L V6	3600	3806	5900			3919	---	450	500	450	500	---	---	---	---	---	---	n/a	---	---	---
DAKOTA SLT	4x4	Reg Cab	No	6.5 Box	4.7L V8	3600	3806	5900			3919	---	450	500	500	500	---	---	---	---	---	---	n/a	---	---	---
DAKOTA SLT	4x4	Club Cab	No	6.5 Box	3.7L V6	3600	3806	6010			3919	---	450	600	500	650	---	---	---	---	---	---	n/a	---	---	---
DAKOTA SLT	4x4	Club Cab	No	6.5 Box	4.7L V8	3600	3806	6010			3919	---	650	---	---	---	---	---	---	---	---	---	n/a	---	---	---
DAKOTA SPORT	4x4	Reg Cab	No	6.5 Box	3.7L V6	3600	3806	5900			3919	---	450	500	500	500	---	---	---	---	---	---	n/a	---	---	---
DAKOTA SPORT	4x4	Club Cab	No	6.5 Box	3.7L V6	3600	3806	6010			3919	---	450	500	500	550	---	---	---	---	---	---	n/a	---	---	---
DAKOTA SPORT	4x4	Club Cab	No	6.5 Box	4.7L V8	3600	3806	6010			3919	---	600	---	---	---	---	---	---	---	---	---	n/a	---	---	---
RAM 1500	4x4	Reg Cab	No	6.5 Box	5.7L V8	3900	3900	6350			63760	3	400	---	---	---	---	---	---	---	---	---	n/a	---	---	---
RAM 2500	4x4	Reg Cab	No	8.0 Box	5.7L V8	5200	6000	8650			63883-2	23	350	350	350	400	350	450	500	500	500	---	n/a	---	---	---
RAM 2500	4x4	Reg Cab	No	8.0 Box	5.9L D	5200	6000	9000			63883-2	23	600	750	650	800	700	---	---	---	---	---	n/a	---	---	---
RAM 2500	4x4	Reg Cab	No	8.0 Box	5.9L D HO	5200	6000	9000			63883-2	23	550	700	600	750	650	---	---	---	---	---	n/a	---	---	---
RAM 2500	4x4	Quad Cab	No	6.5 Box	5.7L V8	5200	6000	8800			63883-2	23	250	300	250	300	300	400	400	400	450	---	n/a	---	---	---
RAM 2500	4x4	Quad Cab	No	6.5 Box	5.9L D	5200	6000	9000			63883-2	23	750	---	900	---	1000	---	---	---	---	---	n/a	---	---	---
RAM 2500	4x4	Quad Cab	No	6.5 Box	5.9L D HO	5200	6000	9000			63883-2	23	450	600	500	650	550	---	---	---	---	---	n/a	---	---	---
RAM 2500	4x4	Quad Cab	No	8.0 Box	5.7L V8	5200	6000	8800			63883-2	23	300	350	300	350	300	400	450	450	450	---	n/a	---	---	---
RAM 2500	4x4	All	No	Chassis	All	All	All	8501			63883-2	23	?	?	?	?	?	?	?	?	?	---	n/a	---	---	---
RAM 2500 SLT	4x4	Reg Cab	No	8.0 Box	5.7L V8	5200	6000	8650			63883-2	23	300	350	350	350	350	450	450	450	500	---	n/a	---	---	---
RAM 2500 SLT	4x4	Reg Cab	No	8.0 Box	5.9L D	5200	6000	9000			63883-2	23	550	800	650	850	750	---	---	---	---	---	n/a	---	---	---
RAM 2500 SLT	4x4	Reg Cab	No	8.0 Box	5.9L D HO	5200	6000	9000			63883-2	23	550	600	550	600	550	---	---	---	---	---	n/a	---	---	---
RAM 2500 SLT	4x4	Quad Cab	No	6.5 Box	5.7L V8	5200	6000	8800			63883-2	23	250	250	250	300	250	350	400	400	400	---	n/a	---	---	---
RAM 2500 SLT	4x4	Quad Cab	No	6.5 Box	5.9L D	5200	6000	9000			63883-2	23	650	950	800	950	900	---	---	---	---	---	n/a	---	---	---
RAM 2500 SLT	4x4	Quad Cab	No	8.0 Box	5.7L V8	5200	6000	8800			63883-2	23	250	300	250	300	300	350	400	400	400	---	n/a	---	---	---
RAM 3500	4x4	Reg Cab	Yes	8.0 Box	5.7L V8	5200	9350	11500			63883-2	23	---	---	---	---	100	---	---	250	250	---	n/a	---	---	---
RAM 3500	4x4	Reg Cab	Yes	8.0 Box	5.9L D	5200	9350	12000			63883-2	23	---	---	---	---	900	---	---	---	---	---	n/a	---	---	---
RAM 3500	4x4	Reg Cab	Yes	8.0 Box	5.9L D HO	5200	9350	12000			63883-2	23	---	---	---	---	650	---	---	---	---	---	n/a	---	---	---
RAM 3500	4x4	Quad Cab	Yes	6.5 Box	5.9L D	5200	6150	9900			63883-2	23	---	---	---	---	800	---	---	---	---	---	n/a	---	---	---
RAM 3500	4x4	Quad Cab	Yes	6.5 Box	5.9L D HO	5200	6150	9900			63883-2	23	---	---	---	---	550	---	---	---	---	---	n/a	---	---	---
RAM 3500	4x4	Quad Cab	Yes	8.0 Box	5.7L V8	5200	9350	11500			63883-2	23	---	---	---	---	50	---	---	150	200	---	n/a	---	---	---
RAM 3500	4x4	All	Yes	Chassis	All	All	All	8501			63883-2	23	---	---	---	---	?	---	---	?	?	---	n/a	---	---	---
RAM 3500	4x2	All	Yes	Chassis	All	All	All	10001			63883-2	23	---	---	---	---	?	---	?	?	?	---	n/a	---	---	---
RAM 3500 SLT	4x4	Reg Cab	Yes	8.0 Box	5.7L V8	5200	9350	11500			63883-2	23	---	---	---	---	100	---	---	250	250	---	n/a	---	---	---
RAM 3500 SLT	4x4	Reg Cab	Yes	8.0 Box	5.9L D	5200	9350	12000			63883-2	23	---	---	---	---	950	---	---	---	---	---	n/a	---	---	---
RAM 3500 SLT	4x4	Reg Cab	Yes	8.0 Box	5.9L D HO	5200	9350	12000			63883-2	23	---	---	---	---	750	---	---	---	---	---	n/a	---	---	---
RAM 3500 SLT	4x4	Quad Cab	Yes	6.5 Box	5.9L D	5200	6150	9900			63883-2	23	---	---	---	---	900	---	---	---	---	---	n/a	---	---	---
RAM 3500 SLT	4x4	Quad Cab	Yes	6.5 Box	5.9L D HO	5200	6150	9900			63883-2	23	---	---	---	---	650	---	---	---	---	---	n/a	---	---	---
RAM 3500 SLT	4x4	Quad Cab	Yes	8.0 Box	5.7L V8	5200	9350	11500			63883-2	23	---	---	---	---	50	---	---	150	200	---	n/a	---	---	---

Notes:
 1. Ballast amounts are based on a "Representative Vehicle," defined in the vehicle selection guide instructions, and must be modified for all other configurations for axle and GVWR compliance.

3. Requires bumper notching.
 23. Requires bumper notching on Sport and LE Sport option.

2004 Dodge

Section 3 MVP® & MVP PLUS™ Blades

UltraMount						
MVP®	MVP PLUS™					
8'-6" STEEL	7'-6" STEEL	7'-6" POLY	8'-6" STEEL	8'-6" POLY	9'-6" STEEL	9'-6" POLY
Plow	IUMVP85	IUTHVPP75	IUTHVPPY75	IUTHVPP85	IUTHVPPY85	IUTHVPPY95
Blade Assembly	63819	44475	44575	44485	44585	44495
AQ&L Assembly Box 1	63910					
AQ&L Assembly Box 2	67951-2	44225				
Hydraulic Kit	64777					
Light Kit	28800					
Choose a Joystick Control or Hand-Held Control	96369	96700				
	96462	96600				

Model	Body Style	DRW	Box Option	Engine Type	Min FAWR	Min RAWR	Min GVWR	Harness Kit	UltraMount® system		550	450	400	500	450	600	550
									Mount Kit	Notes							
RAM 2500	4x4 Reg Cab	No	8.0 Box	5.7L V8	5200	6000	8650	HB5 use 8436	63883-2	23	550	450	400	500	450	600	550
RAM 2500	4x4 Quad Cab	No	6.5 Box	5.7L V8	5200	6000	8800		63883-2	23	450	350	350	400	400	500	500
RAM 2500	4x4 Quad Cab	No	6.5 Box	5.9L D HO	5200	6000	9000		63883-2	23	---	---	950	---	---	---	---
RAM 2500	4x4 Quad Cab	No	8.0 Box	5.7L V8	5200	6000	8800		63883-2	23	500	400	350	450	400	550	500
RAM 2500	4x4 All	No	Chassis	All	All	All	8501		63883-2	23	?	?	?	?	?	?	?
RAM 2500 SLT	4x4 Reg Cab	No	8.0 Box	5.7L V8	5200	6000	8650		63883-2	23	550	400	400	450	450	600	550
RAM 2500 SLT	4x4 Reg Cab	No	8.0 Box	5.9L D HO	5200	6000	9000		63883-2	23	---	---	900	---	---	---	---
RAM 2500 SLT	4x4 Quad Cab	No	6.5 Box	5.7L V8	5200	6000	8800		63883-2	23	450	350	300	400	350	500	450
RAM 2500 SLT	4x4 Quad Cab	No	8.0 Box	5.7L V8	5200	6000	8800		63883-2	23	450	350	350	400	350	500	450
RAM 3500	4x4 Reg Cab	Yes	8.0 Box	5.7L V8	5200	9350	11500		63883-2	23	300	---	---	200	200	350	300
RAM 3500	4x4 Quad Cab	Yes	8.0 Box	5.7L V8	5200	9350	11500		63883-2	23	200	---	---	150	150	550	300
RAM 3500	4x4 All	Yes	Chassis	All	All	All	8501		63883-2	23	?	---	---	?	?	?	?
RAM 3500	4x2 All	Yes	Chassis	All	All	All	10001		63883-2	23	?	---	---	?	?	?	?
RAM 3500 SLT	4x4 Reg Cab	Yes	8.0 Box	5.7L V8	5200	9350	11500		63883-2	23	300	---	---	200	200	350	300
RAM 3500 SLT	4x4 Quad Cab	Yes	8.0 Box	5.7L V8	5200	9350	11500		63883-2	23	200	---	---	150	150	650	400

- Notes:
- Ballast amounts are based on a "Representative Vehicle," defined in the vehicle selection guide instructions, and must be modified for all other configurations for axle and GVWR compliance.
 - Requires bumper notching on Sport and LE Sport option.

2004 Ford

Section 1 Suburbanite™ & MIDWEIGHT™ Blades

	
Suburbanite™	
6'-8" POLY	7'-4" POLY
SUB68	SUB74
Plow	
Blade Assembly	
27546	27548
AQ&L Assembly Box 1	
27550	
AQ&L Assembly Box 2	
n/a	
Hydraulic Kit	
27516	
Light Kit	
64100	
Choose a Joystick Control	
56369	
or Hand-Held Control	
56462	

	
MIDWEIGHT™	
7'-6" STEEL	7'-6" POLY
IUTH75	IUTHY75
64340	64330
64336	
67992	
64620	
28800	
56369	
56462	

Model	Body Style	DRW	Box Option	Engine Type	Min F G A W R	Min R G A W R	Min G V W R	Harness Kit	Personal Plow system		Ballast Guidelines, lbs (1)	UltraMount® system		Ballast Guidelines, lbs (1)	
									Mount Kit	Notes		Mount Kit	Notes		
EXPLORER SPORT TRAC	4x4	---	No	4.0 Box	4.0L V6	2900	3200	5840							
EXCURSION EARLY	4x4	SU-4DR	No	---	5.4L V8	4700	5250	9200							
EXCURSION EARLY	4x4	SU-4DR	No	---	5.4L V8	4700	5250	8900							
EXCURSION EARLY	4x4	SU-4DR	No	---	6.8L V10	4700	5250	9200							
EXCURSION EARLY	4x4	SU-4DR	No	---	6.8L V10	4700	5250	8900							
EXCURSION LATE	4x4	SU-4DR	No	---	5.4L V8	4700	5250	9200							
EXCURSION LATE	4x4	SU-4DR	No	---	5.4L V8	4700	5250	8900							
EXCURSION LATE	4x4	SU-4DR	No	---	6.8L V10	4700	5250	9200							
EXCURSION LATE	4x4	SU-4DR	No	---	6.8L V10	4700	5250	8900							
RANGER	4x4	Reg Cab	No	6.0 Box	3.0L V6	2850	2750	5040							
RANGER	4x4	Reg Cab	No	6.0 Box	3.0L V6	2850	2550	4760							
RANGER	4x4	Reg Cab	No	6.0 Box	3.0L V6	2710	2750	5040							
RANGER	4x4	Reg Cab	No	6.0 Box	3.0L V6	2710	2550	4760							
RANGER	4x4	Reg Cab	No	6.0 Box	3.0L V6	2510	2750	5040							
RANGER	4x4	Reg Cab	No	6.0 Box	4.0L V6	2850	2750	5040							
RANGER	4x4	Reg Cab	No	6.0 Box	4.0L V6	2850	2550	4760							
RANGER	4x4	Reg Cab	No	6.0 Box	4.0L V6	2710	2750	5040							
RANGER	4x4	Reg Cab	No	6.0 Box	4.0L V6	2710	2550	4760							
RANGER	4x4	Reg Cab	No	7.0 Box	3.0L V6	2850	2750	5060							
RANGER	4x4	Reg Cab	No	7.0 Box	3.0L V6	2850	2550	4840							
RANGER	4x4	Reg Cab	No	7.0 Box	3.0L V6	2710	2750	5060							
RANGER	4x4	Reg Cab	No	7.0 Box	3.0L V6	2710	2550	4840							
RANGER	4x4	Reg Cab	No	7.0 Box	3.0L V6	2510	2750	5060							
RANGER	4x4	Reg Cab	No	7.0 Box	4.0L V6	2850	2750	5060							
RANGER	4x4	Reg Cab	No	7.0 Box	4.0L V6	2850	2550	4840							
RANGER	4x4	Reg Cab	No	7.0 Box	4.0L V6	2710	2750	5060							
RANGER	4x4	Reg Cab	No	7.0 Box	4.0L V6	2710	2550	4840							
RANGER	4x4	Super Cab	No	6.0 Box	4.0L V6	2850	2750	5440							
RANGER	4x4	Super Cab	No	6.0 Box	4.0L V6	2850	2750	5320							
RANGER	4x4	Super Cab	No	6.0 Box	4.0L V6	2850	2750	5180							
RANGER	4x4	Super Cab	No	6.0 Box	4.0L V6	2850	2600	5140							
RANGER	4x4	Super Cab	No	6.0 Box	4.0L V6	2850	2600	5000							
RANGER	4x4	Super Cab	No	6.0 Box	4.0L V6	2710	2750	5320							
RANGER	4x4	Super Cab	No	6.0 Box	4.0L V6	2710	2750	5180							

- Notes:**
- Ballast amounts are based on a "Representative Vehicle," defined in the vehicle selection guide instructions, and must be modified for all other configurations for axle and GVWR compliance.
 - "EARLY" indicates a build date before 12-01-2003, "LATE" indicates a build date on or after 12-01-2003.
 - These Snowplows Are For Personal/Homeowner Use Only.

2004 Ford

Section 1 Suburbanite™ & MIDWEIGHT™ Blades

	
Suburbanite™	
6'-8" POLY	7'-4" POLY
SUB68	SUB74
Plow	
Blade Assembly	27546 27548
AQ&L Assembly Box 1	27550
AQ&L Assembly Box 2	n/a
Hydraulic Kit	27516
Light Kit	64100
Choose a Joystick Control	56369
or Hand-Held Control	56462

	
MIDWEIGHT™	
7'-6" STEEL	7'-6" POLY
IUTH75	IUTHY75
64340	64330
64336	
67992	
64620	
28800	
56369	
56462	

Model	Body Style	DRW	Box Option	Engine Type	Min F G A W R	Min R G A W R	Min G V W R	Harness Kit	Personal Plow system		Ballast Guidelines, lbs (1)	UltraMount® system		Ballast Guidelines, lbs (1)				
									Mount Kit	Notes		Mount Kit	Notes					
F150	4x4	Reg Cab	No	6.5 Box	4.6L V8	3600	3500	6800	H13 use 28400	1233	8	---	0	64500	3	---	---	
F150	4x4	Reg Cab	No	6.5 Box	4.6L V8	3450	3500	6800		1233	8	---	250	64500	3	---	---	
F150	4x4	Reg Cab	No	6.5 Box	5.4L V8	3600	3500	6850		1233	8	---	0	64500	3	---	---	
F150	4x4	Reg Cab	No	6.5 Box	5.4L V8	3450	3500	6850		1233	8	---	400	64500	3	---	---	
F150	4x4	Reg Cab	No	8.0 Box	4.6L V8	3750	3800	6950		1233	8	---	0	64500	3	---	---	
F150	4x4	Reg Cab	No	8.0 Box	4.6L V8	3600	3800	6950		1233	8	---	150	64500	3	---	---	
F150	4x4	Reg Cab	No	8.0 Box	4.6L V8	3450	3800	6950		1233	8	---	800	64500	3	---	---	
F150	4x4	Reg Cab	No	8.0 Box	5.4L V8	4300	4900	8200		1233	8	---	0	64500	3	150	150	
F150	4x4	Reg Cab	No	8.0 Box	5.4L V8	4300	4800	8200		1233	8	---	0	64500	3	150	150	
F150	4x4	Reg Cab	No	8.0 Box	5.4L V8	4050	4900	8200		1233	8	---	0	64500	3	550	500	
F150	4x4	Reg Cab	No	8.0 Box	5.4L V8	3750	3850	6950		1233	8	---	50	64500	3	---	---	
F150	4x4	Reg Cab	No	8.0 Box	5.4L V8	3600	3850	6950		1233	8	---	400	64500	3	---	---	
F150	4x4	Super Cab	No	5.5 Box	4.6L V8	3750	3800	6900		1233	8	---	0	64500	3	---	---	
F150	4x4	Super Cab	No	5.5 Box	4.6L V8	3600	3800	6900		1233	8	---	0	64500	3	---	---	
F150	4x4	Super Cab	No	5.5 Box	4.6L V8	3450	3800	6900		1233	8	---	500	64500	3	---	---	
F150	4x4	Super Cab	No	5.5 Box	5.4L V8	3750	3850	7150		1233	8	---	0	64500	3	---	---	
F150	4x4	Super Cab	No	5.5 Box	5.4L V8	3600	3850	7150		1233	8	---	250	64500	3	---	---	
F150	4x4	Super Cab	No	6.5 Box	4.6L V8	3750	3800	6950		1233	8	---	0	64500	3	---	---	
F150	4x4	Super Cab	No	6.5 Box	4.6L V8	3600	3800	6950		1233	8	---	300	64500	3	---	---	
F150	4x4	Super Cab	No	6.5 Box	5.4L V8	3900	3850	7200		1233	8	---	0	64500	3	---	---	
F150	4x4	Super Cab	No	6.5 Box	5.4L V8	3750	3850	7200		1233	8	---	150	64500	3	---	---	
F150	4x4	Super Cab	No	8.0 Box	5.4L V8	4300	4900	8200		1233	8	---	0	64500	3	350	300	
F150	4x4	Super Cab	No	8.0 Box	5.4L V8	4300	4800	8200		1233	8	---	0	64500	3	350	300	
F150	4x4	Super Cab	No	8.0 Box	5.4L V8	4050	4900	8200		1233	8	---	0	64500	3	---	---	
F150	4x4	Super Cab	No	8.0 Box	5.4L V8	4050	4800	8200		1233	8	---	0	64500	3	---	---	
F150	4x4	SuperCrew	No	5.5 Box	4.6L V8	3750	3800	6900		1233	8	---	0	64500	3	---	---	
F150	4x4	SuperCrew	No	5.5 Box	4.6L V8	3600	3800	6900		1233	8	---	500	64500	3	---	---	
F150	4x4	SuperCrew	No	5.5 Box	5.4L V8	3900	3850	7200		1233	8	---	0	64500	3	---	---	
F150	4x4	SuperCrew	No	5.5 Box	5.4L V8	3750	3850	7200		1233	8	---	150	64500	3	---	---	
F150	4x4	SuperCrew	No	5.5 Box	5.4L V8	3600	3850	7200		1233	8	---	750	64500	3	---	---	
F150 HERITAGE	4x4	Reg Cab	No	6.5 Box	4.2L V6	3400	3550	6050		HB5 use 8436	1223	8	---	0	67810	2,10	500	500
F150 HERITAGE	4x4	Reg Cab	No	6.5 Box	4.2L V6	3200	3550	6050			1223	8	---	0	67810	2,10	---	---
F150 HERITAGE	4x4	Reg Cab	No	6.5 Box	4.6L V8	3600	3550	6250			1223	8	---	0	67810	2,10	300	300
F150 HERITAGE	4x4	Reg Cab	No	6.5 Box	4.6L V8	3400	3550	6250			1223	8	---	0	67810	2,10	750	700
F150 HERITAGE	4x4	Reg Cab	No	6.5 Box	4.6L V8	3200	3550	6250	1223		8	---	0	67810	2,10	---	---	

- Notes:**
- Ballast amounts are based on a "Representative Vehicle," defined in the vehicle selection guide instructions, and must be modified for all other configurations for axle and GVWR compliance.
 - Recommended snowplow prep package whenever available.

- Requires bumper notching.
- These Snowplows Are For Personal/Homeowner Use Only.
- May require bumper or air dam notching.

2004 Ford

Section 1 Suburbanite™ & MIDWEIGHT™ Blades

 Suburbanite™	
6'-8" POLY SUB68	7'-4" POLY SUB74
Plow Blade Assembly AQ&L Assembly Box 1 AQ&L Assembly Box 2 Hydraulic Kit Light Kit Choose a Joystick Control or Hand-Held Control	
27546	27548
27550	
n/a	
27516	
64100	
56369	
56462	

 UltraMount™	
MIDWEIGHT™	
7'-6" STEEL IUTH75	7'-6" POLY IUTHY75
64340	64330
64336	
67992	
64620	
28800	
56369	
56462	

Model	Body Style	DRW	Box Option	Engine Type	Min F G A W R	Min R C A W R	Min G V W R	Harness Kit	Personal Plow system		Ballast Guidelines, lbs (1)	UltraMount® system		Ballast Guidelines, lbs (1)				
									Mount Kit	Notes		Mount Kit	Notes					
F150 HERITAGE	4x4	Reg Cab	No	8.0 Box	4.2L V6	3600	3550	6050	HB5 use 8436	1223	8	---	50	67810	2,10	300	300	
F150 HERITAGE	4x4	Reg Cab	No	8.0 Box	4.2L V6	3400	3550	6050		1223	8	---	50	67810	2,10	---	---	
F150 HERITAGE	4x4	Reg Cab	No	8.0 Box	4.6L V8	3600	3550	6250		1223	8	---	50	67810	2,10	400	350	
F150 HERITAGE	4x4	Reg Cab	No	8.0 Box	4.6L V8	3400	3550	6250		1223	8	---	50	67810	2,10	---	---	
F150 HERITAGE	4x4	Reg Cab	No	8.0 Box	5.4L V8 BIF	4150	4800	7700		1223	8	---	0	67810	2,10	150	150	
F150 HERITAGE	4x4	Super Cab	No	6.5 Box	4.6L V8	3600	3550	6250		1223	8	---	0	67810	2,10	500	450	
F150 HERITAGE	4x4	Super Cab	No	6.5 Box	4.6L V8	3400	3550	6250		1223	8	---	0	67810	2,10	---	---	
F150 HERITAGE	4x4	Super Cab	No	6.5 Box	5.4L V8 BIF	4150	4800	7700		1223	8	---	0	67810	2,10	100	100	
F150 HERITAGE	4x4	Super Cab	No	8.0 Box	4.6L V8	3900	3500	6250		1223	8	---	50	67810	2,10	300	300	
F150 HERITAGE	4x4	Super Cab	No	8.0 Box	4.6L V8	3768	3500	6250		1223	8	---	50	67810	2,10	350	300	
F150 HERITAGE	4x4	Super Cab	No	8.0 Box	4.6L V8	3600	3500	6250		1223	8	---	50	67810	2,10	---	---	
F250 SUPER DUTY EARLY	4x4	Reg Cab	No	8.0 Box	5.4L V8	5200	6084	8800		2B use 8439 or HB5 use 8436	n/a	---	---	---	67982	2,7	200	200
F250 SUPER DUTY EARLY	4x4	Reg Cab	No	8.0 Box	5.4L V8	4800	6084	8800			n/a	---	---	---	67982	2,7	200	200
F250 SUPER DUTY EARLY	4x4	Reg Cab	No	8.0 Box	5.4L V8	4400	6084	8800			n/a	---	---	---	67982	2,7	200	200
F250 SUPER DUTY EARLY	4x4	Reg Cab	No	8.0 Box	6.0L D	5200	6084	8800			n/a	---	---	---	67982	2,7	450	450
F250 SUPER DUTY EARLY	4x4	Reg Cab	No	8.0 Box	6.0L D	4800	6084	8800	n/a		---	---	---	67982	2,7	---	1000	
F250 SUPER DUTY EARLY	4x4	Reg Cab	No	8.0 Box	6.8L V10	5200	6084	8800	n/a		---	---	---	67982	2,7	300	300	
F250 SUPER DUTY EARLY	4x4	Reg Cab	No	8.0 Box	6.8L V10	4800	6084	8800	n/a		---	---	---	67982	2,7	300	300	
F250 SUPER DUTY EARLY	4x4	Reg Cab	No	8.0 Box	6.8L V10	4400	6084	8800	n/a		---	---	---	67982	2,7	650	600	
F250 SUPER DUTY EARLY	4x4	Super Cab	No	6.8 Box	5.4L V8	5200	6084	8800	n/a		---	---	---	67982	2,7	150	150	
F250 SUPER DUTY EARLY	4x4	Super Cab	No	6.8 Box	5.4L V8	4800	6084	8800	n/a		---	---	---	67982	2,7	150	150	
F250 SUPER DUTY EARLY	4x4	Super Cab	No	6.8 Box	5.4L V8	4400	6084	8800	n/a		---	---	---	67982	2,7	400	350	
F250 SUPER DUTY EARLY	4x4	Super Cab	No	6.8 Box	6.0L D	5200	6084	8800	n/a		---	---	---	67982	2,7	400	400	
F250 SUPER DUTY EARLY	4x4	Super Cab	No	6.8 Box	6.0L D	4970	6084	8800	n/a		---	---	---	67982	2,7	600	550	
F250 SUPER DUTY EARLY	4x4	Super Cab	No	6.8 Box	6.8L V10	5200	6084	8800	n/a		---	---	---	67982	2,7	250	250	
F250 SUPER DUTY EARLY	4x4	Super Cab	No	6.8 Box	6.8L V10	4800	6084	8800	n/a		---	---	---	67982	2,7	250	250	
F250 SUPER DUTY EARLY	4x4	Super Cab	No	6.8 Box	6.8L V10	4400	6084	8800	n/a		---	---	---	67982	2,7	950	900	
F250 SUPER DUTY EARLY	4x4	Super Cab	No	8.0 Box	5.4L V8	5200	6084	8800	n/a		---	---	---	67982	2,7	200	200	
F250 SUPER DUTY EARLY	4x4	Super Cab	No	8.0 Box	5.4L V8	4800	6084	8800	n/a		---	---	---	67982	2,7	200	200	
F250 SUPER DUTY EARLY	4x4	Super Cab	No	8.0 Box	5.4L V8	4400	6084	8800	n/a		---	---	---	67982	2,7	1000	950	
F250 SUPER DUTY EARLY	4x4	Super Cab	No	8.0 Box	6.0L D	5200	6084	8800	n/a		---	---	---	67982	2,7	450	400	
F250 SUPER DUTY EARLY	4x4	Super Cab	No	8.0 Box	6.8L V10	5200	6084	8800	n/a		---	---	---	67982	2,7	250	250	
F250 SUPER DUTY EARLY	4x4	Super Cab	No	8.0 Box	6.8L V10	4800	6084	8800	n/a		---	---	---	67982	2,7	250	250	
F250 SUPER DUTY EARLY	4x4	Crew Cab	No	6.8 Box	5.4L V8	5200	6084	8800	n/a		---	---	---	67982	2,7	150	150	
F250 SUPER DUTY EARLY	4x4	Crew Cab	No	6.8 Box	5.4L V8	4800	6084	8800	n/a		---	---	---	67982	2,7	150	150	
F250 SUPER DUTY EARLY	4x4	Crew Cab	No	6.8 Box	5.4L V8	4400	6084	8800	n/a		---	---	---	67982	2,7	1000	950	
F250 SUPER DUTY EARLY	4x4	Crew Cab	No	6.8 Box	6.0L D	5200	6084	8800	n/a		---	---	---	67982	2,7	400	350	

Notes:
 1. Ballast amounts are based on a "Representative Vehicle," defined in the vehicle selection guide instructions, and must be modified for all other configurations for axle and GVWR compliance.
 2. Recommended snowplow prep package whenever available.

7. "EARLY" indicates a build date before 12-01-2003, "LATE" indicates a build date on or after 12-01-2003.
 8. These Snowplows Are For Personal/Homeowner Use Only.
 10. May require bumper or air dam notching.

2004 Ford

Section 1 Suburbanite™ & MIDWEIGHT™ Blades

 Suburbanite™	
6'-8" POLY SUB68	7'-4" POLY SUB74
Plow Blade Assembly AQ&L Assembly Box 1 AQ&L Assembly Box 2 Hydraulic Kit Light Kit Choose a Joystick Control or Hand-Held Control	
27546	27548
27550	
n/a	
27516	
64100	
56369	
56462	

 UltraMount™	
MIDWEIGHT™	
7'-6" STEEL IUTH75	7'-6" POLY IUTHY75
64340	64330
64336	
67992	
64620	
28800	
56369	
56462	

Model	Body Style	DRW	Box Option	Engine Type	Min F G A W R	Min R G A W R	Min G V W R	Harness Kit	Personal Plow system		Ballast Guidelines, lbs (1)	UltraMount® system		Ballast Guidelines, lbs (1)	
									Mount Kit	Notes		Mount Kit	Notes		
F250 SUPER DUTY EARLY	4x4	Crew Cab	No	6.8 Box	6.8L V10	5200	6084	8800	n/a	---	---	67982	2,7	200	200
F250 SUPER DUTY EARLY	4x4	Crew Cab	No	6.8 Box	6.8L V10	4800	6084	8800	n/a	---	---	67982	2,7	200	200
F250 SUPER DUTY EARLY	4x4	Crew Cab	No	8.0 Box	5.4L V8	5200	6084	8800	n/a	---	---	67982	2,7	150	150
F250 SUPER DUTY EARLY	4x4	Crew Cab	No	8.0 Box	5.4L V8	4800	6084	8800	n/a	---	---	67982	2,7	150	150
F250 SUPER DUTY EARLY	4x4	Crew Cab	No	8.0 Box	6.8L V10	5200	6084	8800	n/a	---	---	67982	2,7	250	200
F250 SUPER DUTY EARLY	4x4	Crew Cab	No	8.0 Box	6.8L V10	4800	6084	8800	n/a	---	---	67982	2,7	400	350
F250 SUPER DUTY LATE	4x4	Reg Cab	No	8.0 Box	5.4L V8	5200	6084	8800	n/a	---	---	3249	7	200	200
F250 SUPER DUTY LATE	4x4	Reg Cab	No	8.0 Box	5.4L V8	4800	6084	8800	n/a	---	---	3249	7	200	200
F250 SUPER DUTY LATE	4x4	Reg Cab	No	8.0 Box	5.4L V8	4400	6084	8800	n/a	---	---	3249	7	200	200
F250 SUPER DUTY LATE	4x4	Reg Cab	No	8.0 Box	6.0L D	5200	6084	8800	n/a	---	---	3249	7	450	450
F250 SUPER DUTY LATE	4x4	Reg Cab	No	8.0 Box	6.0L D	4800	6084	8800	n/a	---	---	3249	7	---	1000
F250 SUPER DUTY LATE	4x4	Reg Cab	No	8.0 Box	6.8L V10	5200	6084	8800	n/a	---	---	3249	7	300	250
F250 SUPER DUTY LATE	4x4	Reg Cab	No	8.0 Box	6.8L V10	4800	6084	8800	n/a	---	---	3249	7	300	250
F250 SUPER DUTY LATE	4x4	Reg Cab	No	8.0 Box	6.8L V10	4400	6084	8800	n/a	---	---	3249	7	600	550
F250 SUPER DUTY LATE	4x4	Super Cab	No	6.8 Box	5.4L V8	5200	6084	8800	n/a	---	---	3249	7	150	150
F250 SUPER DUTY LATE	4x4	Super Cab	No	6.8 Box	5.4L V8	4800	6084	8800	n/a	---	---	3249	7	150	150
F250 SUPER DUTY LATE	4x4	Super Cab	No	6.8 Box	5.4L V8	4400	6084	8800	n/a	---	---	3249	7	400	350
F250 SUPER DUTY LATE	4x4	Super Cab	No	6.8 Box	6.0L D	5200	6084	8800	n/a	---	---	3249	7	400	400
F250 SUPER DUTY LATE	4x4	Super Cab	No	6.8 Box	6.0L D	4970	6084	8800	n/a	---	---	3249	7	600	550
F250 SUPER DUTY LATE	4x4	Super Cab	No	6.8 Box	6.8L V10	5200	6084	8800	n/a	---	---	3249	7	250	250
F250 SUPER DUTY LATE	4x4	Super Cab	No	6.8 Box	6.8L V10	4800	6084	8800	n/a	---	---	3249	7	250	250
F250 SUPER DUTY LATE	4x4	Super Cab	No	6.8 Box	6.8L V10	4400	6084	8800	n/a	---	---	3249	7	900	900
F250 SUPER DUTY LATE	4x4	Super Cab	No	8.0 Box	5.4L V8	5200	6084	8800	n/a	---	---	3249	7	200	200
F250 SUPER DUTY LATE	4x4	Super Cab	No	8.0 Box	5.4L V8	4800	6084	8800	n/a	---	---	3249	7	200	200
F250 SUPER DUTY LATE	4x4	Super Cab	No	8.0 Box	5.4L V8	4400	6084	8800	n/a	---	---	3249	7	1000	950
F250 SUPER DUTY LATE	4x4	Super Cab	No	8.0 Box	6.0L D	5200	6084	8800	n/a	---	---	3249	7	450	400
F250 SUPER DUTY LATE	4x4	Super Cab	No	8.0 Box	6.8L V10	5200	6084	8800	n/a	---	---	3249	7	250	250
F250 SUPER DUTY LATE	4x4	Super Cab	No	8.0 Box	6.8L V10	4800	6084	8800	n/a	---	---	3249	7	250	250
F250 SUPER DUTY LATE	4x4	Super Cab	No	8.0 Box	6.8L V10	4400	6084	8800	n/a	---	---	3249	7	150	150
F250 SUPER DUTY LATE	4x4	Crew Cab	No	6.8 Box	5.4L V8	5200	6084	8800	n/a	---	---	3249	7	150	150
F250 SUPER DUTY LATE	4x4	Crew Cab	No	6.8 Box	5.4L V8	4800	6084	8800	n/a	---	---	3249	7	150	150
F250 SUPER DUTY LATE	4x4	Crew Cab	No	6.8 Box	5.4L V8	4400	6084	8800	n/a	---	---	3249	7	950	900
F250 SUPER DUTY LATE	4x4	Crew Cab	No	6.8 Box	6.0L D	5200	6084	8800	n/a	---	---	3249	7	350	350
F250 SUPER DUTY LATE	4x4	Crew Cab	No	6.8 Box	6.8L V10	5200	6084	8800	n/a	---	---	3249	7	200	200
F250 SUPER DUTY LATE	4x4	Crew Cab	No	6.8 Box	6.8L V10	4800	6084	8800	n/a	---	---	3249	7	200	200
F250 SUPER DUTY LATE	4x4	Crew Cab	No	8.0 Box	5.4L V8	5200	6084	8800	n/a	---	---	3249	7	150	150
F250 SUPER DUTY LATE	4x4	Crew Cab	No	8.0 Box	5.4L V8	4800	6084	8800	n/a	---	---	3249	7	150	150
F250 SUPER DUTY LATE	4x4	Crew Cab	No	8.0 Box	6.8L V10	5200	6084	8800	n/a	---	---	3249	7	200	200
F250 SUPER DUTY LATE	4x4	Crew Cab	No	8.0 Box	6.8L V10	4800	6084	8800	n/a	---	---	3249	7	200	200

2B use 8439
or HB5 use
8436

- Notes:**
- Ballast amounts are based on a "Representative Vehicle," defined in the vehicle selection guide instructions, and must be modified for all other configurations for axle and GVWR compliance.
 - Recommended snowplow prep package whenever available.
 - "EARLY" indicates a build date before 12-01-2003, "LATE" indicates a build date on or after 12-01-2003.

2004 Ford

Section 2

PRO-PLOW®, PRO PLUS® & Heavy Weight Blades

UltraMount																			UniMount	
PRO-PLOW®										PRO PLUS®									Heavy Weight	
7'-6" STEEL	7'-6" POLY	8'-0" STEEL	8'-0" POLY	8'-6" STEEL	7'-6" STEEL	8'-0" STEEL	8'-6" STEEL	9'-0" STEEL		9'-0" STEEL	10'-0" STEEL									
IUTP75	IUTPY75	IUTP80	IUTPY80	IUTP85	IUTPP75	IUTPP80	IUTPP85	IUTPP90		IUHW90	IUHW10									
60381	62400	60390	62450	60308	64750	66980	66974	66901		62301	62302									
67950					66490							62298-1								
67951-2					64999							62299-1								
64588					28800							64400								
67951-2					56369							28800								
67951-2					56462							56369								
67951-2					56462							56462								

Model	Body Style	DRW	Box Option	Engine Type	Min FAWR	Min RAWR	Min GVWR	Harness Kit	UltraMount® system	Ballast Guidelines, lbs (1)										UniMount® system	Ballast Guidelines, lbs (1)				
									Mount Kit	Notes										Mount Kit	Notes				
EXCURSION EARLY	4x4	SU-4DR	No	---	5.4L V8	4700	5250	9200	HB5 use 8436	67982	7	50	250	150	300	---	---	---	---	---	n/a	---	---	---	
EXCURSION EARLY	4x4	SU-4DR	No	---	5.4L V8	4700	5250	8900		67982	7	50	250	150	300	---	---	---	---	---	---	n/a	---	---	---
EXCURSION EARLY	4x4	SU-4DR	No	---	6.8L V10	4700	5250	9200		67982	7	250	---	300	---	---	---	---	---	---	---	n/a	---	---	---
EXCURSION EARLY	4x4	SU-4DR	No	---	6.8L V10	4700	5250	8900		67982	7	250	---	300	---	---	---	---	---	---	---	n/a	---	---	---
EXCURSION LATE	4x4	SU-4DR	No	---	5.4L V8	4700	5250	9200		3249	7	50	250	100	300	---	---	---	---	---	---	n/a	---	---	---
EXCURSION LATE	4x4	SU-4DR	No	---	5.4L V8	4700	5250	8900		3249	7	50	250	100	300	---	---	---	---	---	---	n/a	---	---	---
EXCURSION LATE	4x4	SU-4DR	No	---	6.8L V10	4700	5250	9200	3249	7	200	---	300	---	---	---	---	---	---	---	n/a	---	---	---	
EXCURSION LATE	4x4	SU-4DR	No	---	6.8L V10	4700	5250	8900	3249	7	200	---	300	---	---	---	---	---	---	---	n/a	---	---	---	
F150	4x4	Reg Cab	No	8.0 Box	5.4L V8	4300	4900	8200	H13 use 28400	64500	3	400	650	500	700	600	---	---	---	---	n/a	---	---	---	
F150	4x4	Reg Cab	No	8.0 Box	5.4L V8	4300	4800	8200	64500	3	400	650	500	700	600	---	---	---	---	---	n/a	---	---	---	
F150 HERITAGE	4x4	Reg Cab	No	8.0 Box	5.4L V8 BIF	4150	4800	7700	HB5 use 8436	67810	2,10	250	450	300	500	400	---	---	---	---	n/a	---	---	---	
F150 HERITAGE	4x4	Super Cab	No	6.5 Box	5.4L V8 BIF	4150	4800	7700		67810	2,10	350	600	500	650	550	---	---	---	---	n/a	---	---	---	
F250 SUPER DUTY EARLY	4x4	Reg Cab	No	8.0 Box	5.4L V8	5200	6084	8800	2B use 8439 or HB5 use 8436	67982	2,7	350	400	350	400	350	450	500	500	500	n/a	---	---	---	
F250 SUPER DUTY EARLY	4x4	Reg Cab	No	8.0 Box	5.4L V8	4800	6084	8800		67982	2,7	350	400	350	400	350	450	500	500	500	500	n/a	---	---	---
F250 SUPER DUTY EARLY	4x4	Reg Cab	No	8.0 Box	5.4L V8	4400	6084	8800		67982	2,7	900	---	1000	---	---	---	---	---	---	---	n/a	---	---	---
F250 SUPER DUTY EARLY	4x4	Reg Cab	No	8.0 Box	6.0L D	5200	6084	8800		67982	2,7	600	600	600	600	600	950	---	---	---	---	n/a	---	---	---
F250 SUPER DUTY EARLY	4x4	Reg Cab	No	8.0 Box	6.8L V10	5200	6084	8800		67982	2,7	400	450	400	450	450	550	550	550	600	600	n/a	---	---	---
F250 SUPER DUTY EARLY	4x4	Reg Cab	No	8.0 Box	6.8L V10	4800	6084	8800		67982	2,7	400	450	400	450	450	550	650	700	800	800	n/a	---	---	---
F250 SUPER DUTY EARLY	4x4	Super Cab	No	6.8 Box	5.4L V8	5200	6084	8800		67982	2,7	300	350	300	350	300	400	450	450	450	450	n/a	---	---	---
F250 SUPER DUTY EARLY	4x4	Super Cab	No	6.8 Box	5.4L V8	4800	6084	8800		67982	2,7	300	350	300	350	300	400	450	450	550	550	n/a	---	---	---
F250 SUPER DUTY EARLY	4x4	Super Cab	No	6.8 Box	6.0L D	5200	6084	8800		67982	2,7	500	700	550	750	650	---	---	---	---	---	n/a	---	---	---
F250 SUPER DUTY EARLY	4x4	Super Cab	No	6.8 Box	6.8L V10	5200	6084	8800		67982	2,7	350	400	400	400	400	500	500	500	550	550	n/a	---	---	---
F250 SUPER DUTY EARLY	4x4	Super Cab	No	6.8 Box	6.8L V10	4800	6084	8800		67982	2,7	350	400	400	450	400	850	900	1000	---	---	n/a	---	---	---
F250 SUPER DUTY EARLY	4x4	Super Cab	No	8.0 Box	5.4L V8	5200	6084	8800		67982	2,7	300	350	350	350	350	450	450	450	500	500	n/a	---	---	---
F250 SUPER DUTY EARLY	4x4	Super Cab	No	8.0 Box	5.4L V8	4800	6084	8800		67982	2,7	300	350	350	350	350	800	950	---	---	---	n/a	---	---	---
F250 SUPER DUTY EARLY	4x4	Super Cab	No	8.0 Box	6.8L V10	5200	6084	8800		67982	2,7	400	400	400	450	400	500	500	550	550	550	n/a	---	---	---
F250 SUPER DUTY EARLY	4x4	Super Cab	No	8.0 Box	6.8L V10	4800	6084	8800		67982	2,7	600	900	750	950	850	---	---	---	---	---	n/a	---	---	---
F250 SUPER DUTY EARLY	4x4	Crew Cab	No	6.8 Box	5.4L V8	5200	6084	8800		67982	2,7	250	300	300	300	300	400	400	400	400	400	n/a	---	---	---
F250 SUPER DUTY EARLY	4x4	Crew Cab	No	6.8 Box	5.4L V8	4800	6084	8800		67982	2,7	250	350	300	400	300	800	900	1000	---	---	n/a	---	---	---
F250 SUPER DUTY EARLY	4x4	Crew Cab	No	6.8 Box	6.8L V10	5200	6084	8800		67982	2,7	300	350	350	350	350	450	450	450	500	500	n/a	---	---	---
F250 SUPER DUTY EARLY	4x4	Crew Cab	No	6.8 Box	6.8L V10	4800	6084	8800		67982	2,7	700	950	800	1000	900	---	---	---	---	---	n/a	---	---	---
F250 SUPER DUTY EARLY	4x4	Crew Cab	No	8.0 Box	5.4L V8	5200	6084	8800		67982	2,7	300	300	300	300	300	400	400	400	450	450	n/a	---	---	---
F250 SUPER DUTY EARLY	4x4	Crew Cab	No	8.0 Box	5.4L V8	4800	6084	8800		67982	2,7	600	850	700	900	800	---	---	---	---	---	n/a	---	---	---
F250 SUPER DUTY EARLY	4x4	Crew Cab	No	8.0 Box	6.8L V10	5200	6084	8800		67982	2,7	350	400	350	400	350	450	450	500	500	500	n/a	---	---	---

- Notes:**
- Ballast amounts are based on a "Representative Vehicle," defined in the vehicle selection guide instructions, and must be modified for all other configurations for axle and GVWR compliance.
 - Recommended snowplow prep package whenever available.

- Requires bumper notching.
- "EARLY" indicates a build date before 12-01-2003, "LATE" indicates a build date on or after 12-01-2003.
- May require bumper or air dam notching.

2004 Ford

Section 2 PRO-PLOW®, PRO PLUS® & Heavy Weight Blades

PRO-PLOW®					PRO PLUS®				
7'-6" STEEL	7'-6" POLY	8'-0" STEEL	8'-0" POLY	8'-6" STEEL	7'-6" STEEL	8'-0" STEEL	8'-6" STEEL	9'-0" STEEL	
IUTP75	IUTPY75	IUTP80	IUTPY80	IUTP85	IUTPP75	IUTPP80	IUTPP85	IUTPP90	
60381	62400	60390	62450	60308	64750	66980	66974	66901	
Blade Assembly					66490				
AQ&L Assembly Box 1					67950				
AQ&L Assembly Box 2					67951-2				
Hydraulic Kit					64588				
Light Kit					28800				
Choose a Joystick Control					56369				
or Hand-Held Control					56462				

Heavy Weight	
9'-0" STEEL	10'-0" STEEL
IUHW90	IUHW10
62301	62302
62298-1	
62299-1	
64400	
28800	
56369	
56462	

Model	Body Style	DRW	Box Option	Engine Type	Min F G A W R	Min R G A W R	Min G V W R	Harness Kit	UltraMount® system		Ballast Guidelines, lbs (1)								UniMount® system		Ballast Guidelines, lbs (1)		
									Mount Kit	Notes	1	2	3	4	5	6	7	8	9	10	Mount Kit	Notes	1
F250 SUPER DUTY LATE	4x4	Reg Cab	No	8.0 Box	5.4L V8	5200	6084	8800	3249	7	350	400	350	400	350	450	500	500	500	n/a	---	---	---
F250 SUPER DUTY LATE	4x4	Reg Cab	No	8.0 Box	5.4L V8	4800	6084	8800	3249	7	350	400	350	400	350	450	500	500	500	n/a	---	---	---
F250 SUPER DUTY LATE	4x4	Reg Cab	No	8.0 Box	5.4L V8	4400	6084	8800	3249	7	900	---	1000	---	---	---	---	---	---	n/a	---	---	---
F250 SUPER DUTY LATE	4x4	Reg Cab	No	8.0 Box	6.0L D	5200	6084	8800	3249	7	550	600	600	600	600	950	---	---	---	n/a	---	---	---
F250 SUPER DUTY LATE	4x4	Reg Cab	No	8.0 Box	6.8L V10	5200	6084	8800	3249	7	400	450	400	450	450	550	550	550	600	n/a	---	---	---
F250 SUPER DUTY LATE	4x4	Reg Cab	No	8.0 Box	6.8L V10	4800	6084	8800	3249	7	400	450	400	450	450	550	600	700	800	n/a	---	---	---
F250 SUPER DUTY LATE	4x4	Super Cab	No	6.8 Box	5.4L V8	5200	6084	8800	3249	7	300	350	300	350	300	400	400	450	450	n/a	---	---	---
F250 SUPER DUTY LATE	4x4	Super Cab	No	6.8 Box	5.4L V8	4800	6084	8800	3249	7	300	350	300	350	300	400	400	450	550	n/a	---	---	---
F250 SUPER DUTY LATE	4x4	Super Cab	No	6.8 Box	6.0L D	5200	6084	8800	3249	7	500	700	550	700	650	---	---	---	---	n/a	---	---	---
F250 SUPER DUTY LATE	4x4	Super Cab	No	6.8 Box	6.8L V10	5200	6084	8800	3249	7	350	400	350	400	400	500	500	500	500	n/a	---	---	---
F250 SUPER DUTY LATE	4x4	Super Cab	No	6.8 Box	6.8L V10	4800	6084	8800	3249	7	350	400	350	400	400	800	900	1000	---	n/a	---	---	---
F250 SUPER DUTY LATE	4x4	Super Cab	No	8.0 Box	5.4L V8	5200	6084	8800	3249	7	300	350	300	350	350	450	450	450	450	n/a	---	---	---
F250 SUPER DUTY LATE	4x4	Super Cab	No	8.0 Box	5.4L V8	4800	6084	8800	3249	7	300	350	300	350	350	800	900	1000	---	n/a	---	---	---
F250 SUPER DUTY LATE	4x4	Super Cab	No	8.0 Box	6.8L V10	5200	6084	8800	3249	7	400	400	400	450	400	500	500	550	550	n/a	---	---	---
F250 SUPER DUTY LATE	4x4	Super Cab	No	8.0 Box	6.8L V10	4800	6084	8800	3249	7	600	850	700	900	800	---	---	---	---	n/a	---	---	---
F250 SUPER DUTY LATE	4x4	Crew Cab	No	6.8 Box	5.4L V8	5200	6084	8800	3249	7	250	300	250	300	300	350	400	400	400	n/a	---	---	---
F250 SUPER DUTY LATE	4x4	Crew Cab	No	6.8 Box	5.4L V8	4800	6084	8800	3249	7	250	350	250	350	300	800	900	1000	---	n/a	---	---	---
F250 SUPER DUTY LATE	4x4	Crew Cab	No	6.8 Box	6.8L V10	5200	6084	8800	3249	7	300	350	350	350	350	450	450	450	500	n/a	---	---	---
F250 SUPER DUTY LATE	4x4	Crew Cab	No	6.8 Box	6.8L V10	4800	6084	8800	3249	7	700	900	800	950	900	---	---	---	---	n/a	---	---	---
F250 SUPER DUTY LATE	4x4	Crew Cab	No	8.0 Box	5.4L V8	5200	6084	8800	3249	7	300	300	300	300	300	400	400	400	450	n/a	---	---	---
F250 SUPER DUTY LATE	4x4	Crew Cab	No	8.0 Box	5.4L V8	4800	6084	8800	3249	7	550	800	650	850	750	---	---	---	---	n/a	---	---	---
F250 SUPER DUTY LATE	4x4	Crew Cab	No	8.0 Box	6.8L V10	5200	6084	8800	3249	7	350	400	350	400	350	450	450	500	500	n/a	---	---	---
F350 SUPER DUTY EARLY	4x4	Reg Cab	No	8.0 Box	5.4L V8	5200	6830	9900	67982	2,7	350	400	350	400	350	450	500	500	500	n/a	---	---	---
F350 SUPER DUTY EARLY	4x4	Reg Cab	No	8.0 Box	5.4L V8	5200	6830	9700	67982	2,7	350	350	350	350	350	450	450	500	500	n/a	---	---	---
F350 SUPER DUTY EARLY	4x4	Reg Cab	No	8.0 Box	5.4L V8	4800	6830	9900	67982	2,7	350	400	350	400	350	450	500	500	500	n/a	---	---	---
F350 SUPER DUTY EARLY	4x4	Reg Cab	No	8.0 Box	5.4L V8	4800	6830	9700	67982	2,7	350	350	350	350	350	450	450	500	500	n/a	---	---	---
F350 SUPER DUTY EARLY	4x4	Reg Cab	No	8.0 Box	5.4L V8	4400	6830	9900	67982	2,7	900	---	1000	---	---	---	---	---	---	n/a	---	---	---
F350 SUPER DUTY EARLY	4x4	Reg Cab	No	8.0 Box	5.4L V8	4400	6830	9700	67982	2,7	750	1000	850	---	950	---	---	---	---	n/a	---	---	---
F350 SUPER DUTY EARLY	4x4	Reg Cab	No	8.0 Box	6.0L D	5200	6830	9900	67982	2,7	600	600	600	650	600	950	---	---	---	n/a	---	---	---
F350 SUPER DUTY EARLY	4x4	Reg Cab	No	8.0 Box	6.0L D	5200	6830	9700	67982	2,7	550	600	600	600	600	800	900	1000	---	n/a	---	---	---
F350 SUPER DUTY EARLY	4x4	Reg Cab	No	8.0 Box	6.8L V10	5200	6830	9900	67982	2,7	400	450	400	450	450	550	550	550	600	n/a	---	---	---
F350 SUPER DUTY EARLY	4x4	Reg Cab	No	8.0 Box	6.8L V10	5200	6830	9700	67982	2,7	400	450	400	450	400	500	550	550	550	n/a	---	---	---
F350 SUPER DUTY EARLY	4x4	Reg Cab	No	8.0 Box	6.8L V10	4800	6830	9900	67982	2,7	400	450	400	450	450	550	550	700	800	n/a	---	---	---
F350 SUPER DUTY EARLY	4x4	Reg Cab	No	8.0 Box	6.8L V10	4800	6830	9700	67982	2,7	400	450	400	450	400	500	550	550	650	n/a	---	---	---

- Notes:**
1. Ballast amounts are based on a "Representative Vehicle," defined in the vehicle selection guide instructions, and must be modified for all other configurations for axle and GVWR compliance.
 2. Recommended snowplow prep package whenever available.
 7. "EARLY" indicates a build date before 12-01-2003, "LATE" indicates a build date on or after 12-01-2003.

2004 Ford

Section 2

PRO-PLOW®, PRO PLUS® & Heavy Weight Blades

UltraMount								
PRO-PLOW®					PRO PLUS®			
7'-6" STEEL	7'-6" POLY	8'-0" STEEL	8'-0" POLY	8'-6" STEEL	7'-6" STEEL	8'-0" STEEL	8'-6" STEEL	9'-0" STEEL
IUTP75	IUTPY75	IUTP80	IUTPY80	IUTP85	IUTPP75	IUTPP80	IUTPP85	IUTPP90
60381	62400	60390	62450	60308	64750	66980	66974	66901
67950					66490			
67951-2								
64588					64999			
28800								
56369								
56462								

UniMount	
Heavy Weight	
9'-0" STEEL	10'-0" STEEL
IUHW90	IUHW10
62301	62302
62298-1	
62299-1	
64400	
28800	
56369	
56462	

Model	Body Style	DRW	Box Option	Engine Type	Min F G A W R	Min R G A W R	Min G V W R	Harness Kit	UltraMount® system		Ballast Guidelines, lbs (1)								UniMount® system		Ballast Guidelines, lbs (1)			
									Mount Kit	Notes	1	2	3	4	5	6	7	8	9	10	Mount Kit	Notes	1	2
F350 SUPER DUTY EARLY	4x4	Reg Cab	Yes	8.0 Box	5.4L V8	5200	8250	11200	67982	2,7	---	---	---	---	250	---	---	350	350	n/a	---	---	---	---
F350 SUPER DUTY EARLY	4x4	Reg Cab	Yes	8.0 Box	5.4L V8	5200	8250	11000	67982	2,7	---	---	---	---	250	---	---	350	400	n/a	---	---	---	---
F350 SUPER DUTY EARLY	4x4	Reg Cab	Yes	8.0 Box	5.4L V8	4800	8250	11200	67982	2,7	---	---	---	---	250	---	---	650	750	n/a	---	---	---	---
F350 SUPER DUTY EARLY	4x4	Reg Cab	Yes	8.0 Box	5.4L V8	4800	8250	11000	67982	2,7	---	---	---	---	450	---	---	---	---	n/a	---	---	---	---
F350 SUPER DUTY EARLY	4x4	Reg Cab	Yes	8.0 Box	6.0L D	5200	8250	11500	67982	2,7	---	---	---	---	500	---	---	---	---	n/a	---	---	---	---
F350 SUPER DUTY EARLY	4x4	Reg Cab	Yes	8.0 Box	6.0L D	5200	8250	11200	67982	2,7	---	---	---	---	500	---	---	---	---	n/a	---	---	---	---
F350 SUPER DUTY EARLY	4x4	Reg Cab	Yes	8.0 Box	6.8L V10	5200	8250	11200	67982	2,7	---	---	---	---	200	---	---	350	350	n/a	---	---	---	---
F350 SUPER DUTY EARLY	4x4	Reg Cab	Yes	8.0 Box	6.8L V10	5200	8250	11000	67982	2,7	---	---	---	---	200	---	---	350	350	n/a	---	---	---	---
F350 SUPER DUTY EARLY	4x4	Reg Cab	Yes	8.0 Box	6.8L V10	4800	8250	11200	67982	2,7	---	---	---	---	200	---	---	950	---	n/a	---	---	---	---
F350 SUPER DUTY EARLY	4x4	Reg Cab	Yes	8.0 Box	6.8L V10	4800	8250	11000	67982	2,7	---	---	---	---	750	---	---	---	---	n/a	---	---	---	---
F350 SUPER DUTY EARLY	4x4	Super Cab	No	6.8 Box	5.4L V8	5200	6830	9900	67982	2,7	300	350	300	350	300	400	450	450	450	n/a	---	---	---	---
F350 SUPER DUTY EARLY	4x4	Super Cab	No	6.8 Box	5.4L V8	5200	6830	9700	67982	2,7	300	300	300	300	300	400	400	450	450	n/a	---	---	---	---
F350 SUPER DUTY EARLY	4x4	Super Cab	No	6.8 Box	5.4L V8	4800	6830	9900	67982	2,7	300	350	300	350	300	400	450	450	550	n/a	---	---	---	---
F350 SUPER DUTY EARLY	4x4	Super Cab	No	6.8 Box	5.4L V8	4800	6830	9700	67982	2,7	300	300	300	300	300	400	400	450	450	n/a	---	---	---	---
F350 SUPER DUTY EARLY	4x4	Super Cab	No	6.8 Box	5.4L V8	4400	6830	9700	67982	2,7	1000	---	---	---	---	---	---	---	---	n/a	---	---	---	---
F350 SUPER DUTY EARLY	4x4	Super Cab	No	6.8 Box	6.0L D	5200	6830	9900	67982	2,7	500	700	550	750	650	---	---	---	---	n/a	---	---	---	---
F350 SUPER DUTY EARLY	4x4	Super Cab	No	6.8 Box	6.0L D	5200	6830	9700	67982	2,7	500	550	500	600	550	1000	---	---	---	n/a	---	---	---	---
F350 SUPER DUTY EARLY	4x4	Super Cab	No	6.8 Box	6.8L V10	5200	6830	9900	67982	2,7	350	400	400	400	400	500	500	500	550	n/a	---	---	---	---
F350 SUPER DUTY EARLY	4x4	Super Cab	No	6.8 Box	6.8L V10	4800	6830	9700	67982	2,7	350	400	350	400	400	450	500	500	500	n/a	---	---	---	---
F350 SUPER DUTY EARLY	4x4	Super Cab	No	6.8 Box	6.8L V10	4800	6830	9700	67982	2,7	350	400	400	400	400	800	900	1000	---	n/a	---	---	---	---
F350 SUPER DUTY EARLY	4x4	Super Cab	No	6.8 Box	6.8L V10	4800	6830	9700	67982	2,7	350	400	350	400	400	700	800	850	950	n/a	---	---	---	---
F350 SUPER DUTY EARLY	4x4	Super Cab	No	8.0 Box	5.4L V8	5200	6830	9900	67982	2,7	300	350	350	350	350	450	450	450	500	n/a	---	---	---	---
F350 SUPER DUTY EARLY	4x4	Super Cab	No	8.0 Box	5.4L V8	5200	6830	9700	67982	2,7	300	350	300	350	350	400	450	450	450	n/a	---	---	---	---
F350 SUPER DUTY EARLY	4x4	Super Cab	No	8.0 Box	5.4L V8	4800	6830	9900	67982	2,7	300	350	350	350	350	800	900	---	---	n/a	---	---	---	---
F350 SUPER DUTY EARLY	4x4	Super Cab	No	8.0 Box	5.4L V8	4800	6830	9700	67982	2,7	300	350	300	350	350	650	750	900	1000	n/a	---	---	---	---
F350 SUPER DUTY EARLY	4x4	Super Cab	No	8.0 Box	6.0L D	5200	6830	9700	67982	2,7	900	---	---	---	---	---	---	---	---	n/a	---	---	---	---
F350 SUPER DUTY EARLY	4x4	Super Cab	No	8.0 Box	6.8L V10	5200	6830	9900	67982	2,7	350	400	400	400	400	500	500	500	550	n/a	---	---	---	---
F350 SUPER DUTY EARLY	4x4	Super Cab	No	8.0 Box	6.8L V10	5200	6830	9700	67982	2,7	350	400	400	400	400	500	500	500	550	n/a	---	---	---	---
F350 SUPER DUTY EARLY	4x4	Super Cab	No	8.0 Box	6.8L V10	4800	6830	9900	67982	2,7	700	950	800	1000	900	---	---	---	---	n/a	---	---	---	---
F350 SUPER DUTY EARLY	4x4	Super Cab	No	8.0 Box	6.8L V10	4800	6830	9700	67982	2,7	550	800	650	850	750	---	---	---	---	n/a	---	---	---	---
F350 SUPER DUTY EARLY	4x4	Super Cab	Yes	8.0 Box	5.4L V8	5200	8250	11200	67982	2,7	---	---	---	---	150	---	---	300	300	n/a	---	---	---	---
F350 SUPER DUTY EARLY	4x4	Super Cab	Yes	8.0 Box	5.4L V8	5200	8250	11000	67982	2,7	---	---	---	---	150	---	---	300	300	n/a	---	---	---	---
F350 SUPER DUTY EARLY	4x4	Super Cab	Yes	8.0 Box	5.4L V8	4800	8250	11200	67982	2,7	---	---	---	---	400	---	---	---	---	n/a	---	---	---	---
F350 SUPER DUTY EARLY	4x4	Super Cab	Yes	8.0 Box	6.8L V10	5200	8250	11200	67982	2,7	---	---	---	---	200	---	---	300	300	n/a	---	---	---	---
F350 SUPER DUTY EARLY	4x4	Super Cab	Yes	8.0 Box	6.8L V10	5200	8250	11000	67982	2,7	---	---	---	---	200	---	---	600	750	n/a	---	---	---	---

Notes:
 1. Ballast amounts are based on a "Representative Vehicle," defined in the vehicle selection guide instructions, and must be modified for all other configurations for axle and GVWR compliance.
 2. Recommended snowplow prep package whenever available.
 7. "EARLY" indicates a build date before 12-01-2003, "LATE" indicates a build date on or after 12-01-2003.

2004 Ford

Section 2 PRO-PLOW®, PRO PLUS® & Heavy Weight Blades

UltraMount																				UniMount				
PRO-PLOW®										PRO PLUS®										Heavy Weight				
7'-6" STEEL	7'-6" POLY	8'-0" STEEL	8'-0" POLY	8'-6" STEEL	7'-6" STEEL	8'-0" STEEL	8'-6" STEEL	9'-0" STEEL		9'-0" STEEL	10'-0" STEEL													
IUTP75	IUTP75	IUTP80	IUTPY80	IUTP85	IUTPP75	IUTPP80	IUTPP85	IUTPP90		IUHW90	IUHW10													
60381	62400	60390	62450	60308	64750	66980	66974	66901		62301	62302													
67950					66490							62298-1												
67951-2												62299-1												
64588					64999							64400												
28800												28800												
56369												56369												
56462												56462												
Model	Body Style	DRW	Box Option	Engine Type	Min F G A W R	Min R G A W R	Min G V W R	Harness Kit	UltraMount® system	Ballast Guidelines, lbs (1)										UniMount® system	Ballast Guidelines, lbs (1)			
									Mount Kit	Notes											Mount Kit	Notes		
F350 SUPER DUTY EARLY	4x4	Crew Cab	No	6.8 Box	5.4L V8	5200	6830	9900	67982	2,7	250	300	300	300	300	400	400	400	400	n/a	---	---	---	
F350 SUPER DUTY EARLY	4x4	Crew Cab	No	6.8 Box	5.4L V8	5200	6830	9700	67982	2,7	250	300	250	300	300	350	400	400	400	n/a	---	---	---	
F350 SUPER DUTY EARLY	4x4	Crew Cab	No	6.8 Box	5.4L V8	4800	6830	9900	67982	2,7	250	350	300	400	300	800	900	1000	---	n/a	---	---	---	
F350 SUPER DUTY EARLY	4x4	Crew Cab	No	6.8 Box	5.4L V8	4800	6830	9700	67982	2,7	250	300	250	300	300	650	750	850	950	n/a	---	---	---	
F350 SUPER DUTY EARLY	4x4	Crew Cab	No	6.8 Box	6.0L D	5200	6830	9900	67982	2,7	1000	---	---	---	---	---	---	---	---	n/a	---	---	---	
F350 SUPER DUTY EARLY	4x4	Crew Cab	No	6.8 Box	6.0L D	5200	6830	9700	67982	2,7	900	---	1000	---	---	---	---	---	---	n/a	---	---	---	
F350 SUPER DUTY EARLY	4x4	Crew Cab	No	6.8 Box	6.8L V10	5200	6830	9900	67982	2,7	250	300	300	300	400	400	400	400	400	n/a	---	---	---	
F350 SUPER DUTY EARLY	4x4	Crew Cab	No	6.8 Box	6.8L V10	5200	6830	9700	67982	2,7	250	300	250	300	300	350	400	400	400	n/a	---	---	---	
F350 SUPER DUTY EARLY	4x4	Crew Cab	No	6.8 Box	6.8L V10	4800	6830	9900	67982	2,7	250	350	300	400	300	800	900	1000	---	n/a	---	---	---	
F350 SUPER DUTY EARLY	4x4	Crew Cab	No	6.8 Box	6.8L V10	4800	6830	9700	67982	2,7	250	300	250	300	300	650	750	850	950	n/a	---	---	---	
F350 SUPER DUTY EARLY	4x4	Crew Cab	No	8.0 Box	5.4L V8	5200	6830	9900	67982	2,7	300	300	300	350	300	400	400	400	450	n/a	---	---	---	
F350 SUPER DUTY EARLY	4x4	Crew Cab	No	8.0 Box	5.4L V8	5200	6830	9700	67982	2,7	250	300	300	300	400	400	400	400	450	n/a	---	---	---	
F350 SUPER DUTY EARLY	4x4	Crew Cab	No	8.0 Box	5.4L V8	4800	6830	9900	67982	2,7	600	850	700	850	800	---	---	---	---	n/a	---	---	---	
F350 SUPER DUTY EARLY	4x4	Crew Cab	No	8.0 Box	5.4L V8	4800	6830	9700	67982	2,7	450	700	550	750	650	---	---	---	---	n/a	---	---	---	
F350 SUPER DUTY EARLY	4x4	Crew Cab	No	8.0 Box	6.8L V10	5200	6830	9900	67982	2,7	350	400	350	400	350	450	450	500	500	n/a	---	---	---	
F350 SUPER DUTY EARLY	4x4	Crew Cab	No	8.0 Box	6.8L V10	5200	6830	9700	67982	2,7	350	350	350	400	350	450	450	450	500	n/a	---	---	---	
F350 SUPER DUTY EARLY	4x4	Crew Cab	Yes	6.8 Box	6.8L V10	5200	8250	11500	67982	2,7	---	---	---	---	200	---	---	300	300	n/a	---	---	---	
F350 SUPER DUTY EARLY	4x4	Crew Cab	Yes	6.8 Box	6.8L V10	5200	8250	11200	67982	2,7	---	---	---	---	200	---	---	300	300	n/a	---	---	---	
F350 SUPER DUTY EARLY	4x4	Crew Cab	Yes	6.8 Box	6.8L V10	5200	8250	11000	67982	2,7	---	---	---	---	200	---	---	300	300	n/a	---	---	---	
F350 SUPER DUTY EARLY	4x4	Crew Cab	Yes	8.0 Box	6.8L V10	5200	8250	11500	67982	2,7	---	---	---	---	150	---	---	500	600	n/a	---	---	---	
F350 SUPER DUTY EARLY	4x4	Crew Cab	Yes	8.0 Box	6.8L V10	5200	8250	11200	67982	2,7	---	---	---	---	150	---	---	500	600	n/a	---	---	---	
F350 SUPER DUTY EARLY	4x4	Crew Cab	Yes	8.0 Box	6.8L V10	5200	8250	11000	67982	2,7	---	---	---	---	150	---	---	500	600	n/a	---	---	---	
F350 SUPER DUTY EARLY	4x4	All	No	Chassis	All	All	All	8501	67982	2,7	?	?	?	?	?	?	?	?	?	n/a	---	---	---	
F350 SUPER DUTY EARLY	4x4	All	Yes	Chassis	All	All	All	8501	67982	2,7	---	---	---	---	?	---	---	?	?	n/a	---	---	---	
F350 SUPER DUTY LATE	4x4	Reg Cab	No	8.0 Box	5.4L V8	5200	6830	9900	3249	7	350	400	350	400	350	450	500	500	500	n/a	---	---	---	
F350 SUPER DUTY LATE	4x4	Reg Cab	No	8.0 Box	5.4L V8	5200	6830	9700	3249	7	300	350	350	350	350	450	450	500	500	n/a	---	---	---	
F350 SUPER DUTY LATE	4x4	Reg Cab	No	8.0 Box	5.4L V8	4800	6830	9900	3249	7	350	400	350	400	350	450	500	500	500	n/a	---	---	---	
F350 SUPER DUTY LATE	4x4	Reg Cab	No	8.0 Box	5.4L V8	4800	6830	9700	3249	7	300	350	350	350	350	450	450	500	500	n/a	---	---	---	
F350 SUPER DUTY LATE	4x4	Reg Cab	No	8.0 Box	5.4L V8	4400	6830	9900	3249	7	900	---	1000	---	---	---	---	---	---	n/a	---	---	---	
F350 SUPER DUTY LATE	4x4	Reg Cab	No	8.0 Box	5.4L V8	4400	6830	9700	3249	7	750	1000	850	---	950	---	---	---	---	n/a	---	---	---	
F350 SUPER DUTY LATE	4x4	Reg Cab	No	8.0 Box	6.0L D	5200	6830	9900	3249	7	550	600	600	600	600	950	1000	---	---	n/a	---	---	---	
F350 SUPER DUTY LATE	4x4	Reg Cab	No	8.0 Box	6.0L D	5200	6830	9700	3249	7	550	600	600	600	600	800	900	1000	---	n/a	---	---	---	
F350 SUPER DUTY LATE	4x4	Reg Cab	No	8.0 Box	6.8L V10	5200	6830	9900	3249	7	400	450	400	450	450	550	550	550	600	n/a	---	---	---	
F350 SUPER DUTY LATE	4x4	Reg Cab	No	8.0 Box	6.8L V10	5200	6830	9700	3249	7	400	450	400	450	400	500	550	550	550	n/a	---	---	---	
F350 SUPER DUTY LATE	4x4	Reg Cab	No	8.0 Box	6.8L V10	4800	6830	9900	3249	7	400	450	400	450	450	550	600	700	800	n/a	---	---	---	
F350 SUPER DUTY LATE	4x4	Reg Cab	No	8.0 Box	6.8L V10	4800	6830	9700	3249	7	400	450	400	450	400	500	550	550	550	n/a	---	---	---	

- Notes:**
- Ballast amounts are based on a "Representative Vehicle," defined in the vehicle selection guide instructions, and must be modified for all other configurations for axle and GVWR compliance.
 - Recommended snowplow prep package whenever available.
 - "EARLY" indicates a build date before 12-01-2003, "LATE" indicates a build date on or after 12-01-2003.

2004 Ford

Section 2 PRO-PLOW®, PRO PLUS® & Heavy Weight Blades

UltraMount								
PRO-PLOW®					PRO PLUS®			
7'-6" STEEL	7'-6" POLY	8'-0" STEEL	8'-0" POLY	8'-6" STEEL	7'-6" STEEL	8'-0" STEEL	8'-6" STEEL	9'-0" STEEL
IUTP75	IUTP75	IUTP80	IUTP80	IUTP85	IUTPP75	IUTPP80	IUTPP85	IUTPP90
60381	62400	60390	62450	60308	64750	66980	66974	66901
Blade Assembly					66490			
AQ&L Assembly Box 1					67950			
AQ&L Assembly Box 2					67951-2			
Hydraulic Kit					64588		64999	
Light Kit					28800			
Choose a Joystick Control or Hand-Held Control					56369			
					56462			

UniMount	
Heavy Weight	
9'-0" STEEL	10'-0" STEEL
IUHW90	IUHW10
62301	62302
62298-1	
62299-1	
64400	
28800	
56369	
56462	

Model	Body Style	DRW	Box Option	Engine Type	Min F G A W R	Min R G A W R	Min G V W R	Harness Kit	UltraMount® system		Ballast Guidelines, lbs (1)								UniMount® system		Ballast Guidelines, lbs (1)		
									Mount Kit	Notes	1	2	3	4	5	6	7	8	9	10	11	12	Mount Kit
F350 SUPER DUTY LATE	4x4	Reg Cab	Yes	8.0 Box	5.4L V8	5200	8250	11200	3249	7	---	---	---	---	250	---	---	350	350	n/a	---	---	---
F350 SUPER DUTY LATE	4x4	Reg Cab	Yes	8.0 Box	5.4L V8	5200	8250	11000	3249	7	---	---	---	---	250	---	---	350	350	n/a	---	---	---
F350 SUPER DUTY LATE	4x4	Reg Cab	Yes	8.0 Box	5.4L V8	4800	8250	11200	3249	7	---	---	---	---	250	---	---	600	700	n/a	---	---	---
F350 SUPER DUTY LATE	4x4	Reg Cab	Yes	8.0 Box	5.4L V8	4800	8250	11000	3249	7	---	---	---	---	450	---	---	---	---	n/a	---	---	---
F350 SUPER DUTY LATE	4x4	Reg Cab	Yes	8.0 Box	6.0L D	5200	8250	11500	3249	7	---	---	---	---	500	---	---	---	---	n/a	---	---	---
F350 SUPER DUTY LATE	4x4	Reg Cab	Yes	8.0 Box	6.0L D	5200	8250	11200	3249	7	---	---	---	---	500	---	---	---	---	n/a	---	---	---
F350 SUPER DUTY LATE	4x4	Reg Cab	Yes	8.0 Box	6.8L V10	5200	8250	11200	3249	7	---	---	---	---	200	---	---	350	350	n/a	---	---	---
F350 SUPER DUTY LATE	4x4	Reg Cab	Yes	8.0 Box	6.8L V10	5200	8250	11000	3249	7	---	---	---	---	200	---	---	350	350	n/a	---	---	---
F350 SUPER DUTY LATE	4x4	Reg Cab	Yes	8.0 Box	6.8L V10	4800	8250	11200	3249	7	---	---	---	---	200	---	---	900	1000	n/a	---	---	---
F350 SUPER DUTY LATE	4x4	Reg Cab	Yes	8.0 Box	6.8L V10	4800	8250	11000	3249	7	---	---	---	---	750	---	---	---	---	n/a	---	---	---
F350 SUPER DUTY LATE	4x4	Super Cab	No	6.8 Box	5.4L V8	5200	6830	9900	3249	7	300	350	300	350	300	400	400	450	450	n/a	---	---	---
F350 SUPER DUTY LATE	4x4	Super Cab	No	6.8 Box	5.4L V8	5200	6830	9700	3249	7	250	300	300	300	300	400	400	400	450	n/a	---	---	---
F350 SUPER DUTY LATE	4x4	Super Cab	No	6.8 Box	5.4L V8	4800	6830	9900	3249	7	300	350	300	350	300	400	400	450	550	n/a	---	---	---
F350 SUPER DUTY LATE	4x4	Super Cab	No	6.8 Box	5.4L V8	4800	6830	9700	3249	7	250	300	300	300	300	400	400	400	450	n/a	---	---	---
F350 SUPER DUTY LATE	4x4	Super Cab	No	6.8 Box	5.4L V8	4400	6830	9700	3249	7	1000	---	---	---	---	---	---	---	---	n/a	---	---	---
F350 SUPER DUTY LATE	4x4	Super Cab	No	6.8 Box	6.0L D	5200	6830	9900	3249	7	500	650	550	700	650	---	---	---	---	n/a	---	---	---
F350 SUPER DUTY LATE	4x4	Super Cab	No	6.8 Box	6.0L D	5200	6830	9700	3249	7	500	550	500	600	550	950	---	---	---	n/a	---	---	---
F350 SUPER DUTY LATE	4x4	Super Cab	No	6.8 Box	6.8L V10	5200	6830	9900	3249	7	350	400	350	400	400	500	500	500	500	n/a	---	---	---
F350 SUPER DUTY LATE	4x4	Super Cab	No	6.8 Box	6.8L V10	5200	6830	9700	3249	7	350	400	350	400	350	450	500	500	500	n/a	---	---	---
F350 SUPER DUTY LATE	4x4	Super Cab	No	6.8 Box	6.8L V10	4800	6830	9900	3249	7	350	400	350	400	400	800	900	1000	---	n/a	---	---	---
F350 SUPER DUTY LATE	4x4	Super Cab	No	6.8 Box	6.8L V10	4800	6830	9700	3249	7	350	400	350	400	350	700	750	850	950	n/a	---	---	---
F350 SUPER DUTY LATE	4x4	Super Cab	No	8.0 Box	5.4L V8	5200	6830	9900	3249	7	300	350	350	350	350	450	450	450	500	n/a	---	---	---
F350 SUPER DUTY LATE	4x4	Super Cab	No	8.0 Box	5.4L V8	5200	6830	9700	3249	7	300	350	300	350	350	650	750	850	950	n/a	---	---	---
F350 SUPER DUTY LATE	4x4	Super Cab	No	8.0 Box	6.0L D	5200	6830	9700	3249	7	900	---	1000	---	---	---	---	---	---	n/a	---	---	---
F350 SUPER DUTY LATE	4x4	Super Cab	No	8.0 Box	6.8L V10	5200	6830	9900	3249	7	350	400	400	400	400	500	500	500	550	n/a	---	---	---
F350 SUPER DUTY LATE	4x4	Super Cab	No	8.0 Box	6.8L V10	5200	6830	9700	3249	7	350	400	350	400	400	500	500	500	500	n/a	---	---	---
F350 SUPER DUTY LATE	4x4	Super Cab	No	8.0 Box	6.8L V10	4800	6830	9900	3249	7	700	950	800	1000	900	---	---	---	---	n/a	---	---	---
F350 SUPER DUTY LATE	4x4	Super Cab	No	8.0 Box	6.8L V10	4800	6830	9700	3249	7	550	800	650	850	750	---	---	---	---	n/a	---	---	---
F350 SUPER DUTY LATE	4x4	Super Cab	Yes	8.0 Box	5.4L V8	5200	8250	11200	3249	7	---	---	---	---	150	---	---	300	300	n/a	---	---	---
F350 SUPER DUTY LATE	4x4	Super Cab	Yes	8.0 Box	5.4L V8	5200	8250	11000	3249	7	---	---	---	---	150	---	---	300	300	n/a	---	---	---
F350 SUPER DUTY LATE	4x4	Super Cab	Yes	8.0 Box	5.4L V8	4800	8250	11200	3249	7	---	---	---	---	400	---	---	---	---	n/a	---	---	---
F350 SUPER DUTY LATE	4x4	Super Cab	Yes	8.0 Box	5.4L V8	4800	8250	11000	3249	7	---	---	---	---	1000	---	---	---	---	n/a	---	---	---
F350 SUPER DUTY LATE	4x4	Super Cab	Yes	8.0 Box	6.8L V10	5200	8250	11200	3249	7	---	---	---	---	150	---	---	300	300	n/a	---	---	---
F350 SUPER DUTY LATE	4x4	Super Cab	Yes	8.0 Box	6.8L V10	5200	8250	11000	3249	7	---	---	---	---	200	---	---	600	700	n/a	---	---	---

Notes:
 1. Ballast amounts are based on a "Representative Vehicle," defined in the vehicle selection guide instructions, and must be modified for all other configurations for axle and GVWR compliance.
 7. "EARLY" indicates a build date before 12-01-2003, "LATE" indicates a build date on or after 12-01-2003.

2004 Ford

Section 2

PRO-PLOW®, PRO PLUS® & Heavy Weight Blades

PRO-PLOW®					PRO PLUS®			
7'-6" STEEL	7'-6" POLY	8'-0" STEEL	8'-0" POLY	8'-6" STEEL	7'-6" STEEL	8'-0" STEEL	8'-6" STEEL	9'-0" STEEL
IUTP75	IUTPY75	IUTP80	IUTPY80	IUTP85	IUTPP75	IUTPP80	IUTPP85	IUTPP90
60381	62400	60390	62450	60308	64750	66980	66974	66901
Blade Assembly AQ&L Assembly Box 1					66490			
AQ&L Assembly Box 2					67951-2			
Hydraulic Kit					64588			
Light Kit					28800			
Choose a Joystick Control or Hand-Held Control					56369			
					56462			

Heavy Weight	
9'-0" STEEL	10'-0" STEEL
IUHW90	IUHW10
62301	62302
62298-1	
62299-1	
64400	
28800	
56369	
56462	

Model	Body Style	DRW	Box Option	Engine Type	Min F G A W R	Min R G A W R	Min G V W R	Harness Kit	UltraMount® system		Ballast Guidelines, lbs (1)								UniMount® system		Ballast Guidelines, lbs (1)		
									Mount Kit	Notes	Mount Kit	Notes	Mount Kit	Notes	Mount Kit	Notes	Mount Kit	Notes					
F350 SUPER DUTY LATE	4x4	Crew Cab	No	6.8 Box	5.4L V8	5200	6830	9900	3249	7	250	300	300	300	300	350	400	400	400	n/a	---	---	---
F350 SUPER DUTY LATE	4x4	Crew Cab	No	6.8 Box	5.4L V8	5200	6830	9700	3249	7	250	300	250	300	300	350	400	400	400	n/a	---	---	---
F350 SUPER DUTY LATE	4x4	Crew Cab	No	6.8 Box	5.4L V8	4800	6830	9900	3249	7	250	350	300	350	300	800	900	950	---	n/a	---	---	---
F350 SUPER DUTY LATE	4x4	Crew Cab	No	6.8 Box	5.4L V8	4800	6830	9700	3249	7	250	300	250	300	300	650	750	850	950	n/a	---	---	---
F350 SUPER DUTY LATE	4x4	Crew Cab	No	6.8 Box	6.0L D	5200	6830	9900	3249	7	1000	---	---	---	---	---	---	---	---	n/a	---	---	---
F350 SUPER DUTY LATE	4x4	Crew Cab	No	6.8 Box	6.0L D	5200	6830	9700	3249	7	850	---	950	---	---	---	---	---	---	n/a	---	---	---
F350 SUPER DUTY LATE	4x4	Crew Cab	No	6.8 Box	6.8L V10	5200	6830	9900	3249	7	250	300	300	300	350	400	400	400	400	n/a	---	---	---
F350 SUPER DUTY LATE	4x4	Crew Cab	No	6.8 Box	6.8L V10	5200	6830	9700	3249	7	250	300	250	300	300	350	400	400	400	n/a	---	---	---
F350 SUPER DUTY LATE	4x4	Crew Cab	No	6.8 Box	6.8L V10	4800	6830	9900	3249	7	250	350	300	350	300	800	900	950	---	n/a	---	---	---
F350 SUPER DUTY LATE	4x4	Crew Cab	No	6.8 Box	6.8L V10	4800	6830	9700	3249	7	250	300	250	300	300	650	750	850	950	n/a	---	---	---
F350 SUPER DUTY LATE	4x4	Crew Cab	No	8.0 Box	5.4L V8	5200	6830	9900	3249	7	300	300	300	300	300	400	400	400	450	n/a	---	---	---
F350 SUPER DUTY LATE	4x4	Crew Cab	No	8.0 Box	5.4L V8	5200	6830	9700	3249	7	250	300	300	300	300	400	400	400	450	n/a	---	---	---
F350 SUPER DUTY LATE	4x4	Crew Cab	No	8.0 Box	5.4L V8	4800	6830	9900	3249	7	550	800	650	850	750	---	---	---	---	n/a	---	---	---
F350 SUPER DUTY LATE	4x4	Crew Cab	No	8.0 Box	5.4L V8	4800	6830	9700	3249	7	400	650	500	700	600	---	---	---	---	n/a	---	---	---
F350 SUPER DUTY LATE	4x4	Crew Cab	No	8.0 Box	6.8L V10	5200	6830	9900	3249	7	350	400	350	400	350	450	450	500	500	n/a	---	---	---
F350 SUPER DUTY LATE	4x4	Crew Cab	No	8.0 Box	6.8L V10	5200	6830	9700	3249	7	350	350	350	350	350	450	450	450	500	n/a	---	---	---
F350 SUPER DUTY LATE	4x4	Crew Cab	Yes	6.8 Box	6.8L V10	5200	8250	11500	3249	7	---	---	---	---	150	---	---	300	300	n/a	---	---	---
F350 SUPER DUTY LATE	4x4	Crew Cab	Yes	6.8 Box	6.8L V10	5200	8250	11200	3249	7	---	---	---	---	150	---	---	300	300	n/a	---	---	---
F350 SUPER DUTY LATE	4x4	Crew Cab	Yes	6.8 Box	6.8L V10	5200	8250	11000	3249	7	---	---	---	---	150	---	---	300	300	n/a	---	---	---
F350 SUPER DUTY LATE	4x4	Crew Cab	Yes	6.8 Box	6.8L V10	4800	8250	11500	3249	7	---	---	---	---	1000	---	---	---	---	n/a	---	---	---
F350 SUPER DUTY LATE	4x4	Crew Cab	Yes	6.8 Box	6.8L V10	4800	8250	11200	3249	7	---	---	---	---	1000	---	---	---	---	n/a	---	---	---
F350 SUPER DUTY LATE	4x4	Crew Cab	Yes	6.8 Box	6.8L V10	4800	8250	11000	3249	7	---	---	---	---	1000	---	---	---	---	n/a	---	---	---
F350 SUPER DUTY LATE	4x4	Crew Cab	Yes	8.0 Box	6.8L V10	5200	8250	11500	3249	7	---	---	---	---	150	---	---	500	600	n/a	---	---	---
F350 SUPER DUTY LATE	4x4	Crew Cab	Yes	8.0 Box	6.8L V10	5200	8250	11200	3249	7	---	---	---	---	150	---	---	500	600	n/a	---	---	---
F350 SUPER DUTY LATE	4x4	Crew Cab	Yes	8.0 Box	6.8L V10	5200	8250	11000	3249	7	---	---	---	---	150	---	---	500	600	n/a	---	---	---
F350 SUPER DUTY LATE	4x4	All	No	Chassis	All	All	All	8501	3249	7	?	?	?	?	?	?	?	?	?	n/a	---	---	---
F350 SUPER DUTY LATE	4x4	All	Yes	Chassis	All	All	All	8501	3249	7	---	---	---	---	?	---	---	?	?	n/a	---	---	---
F450 SUPER DUTY EARLY	4x4	All	Yes	Chassis	All	All	All	8501	67982	2,7	---	---	---	---	---	---	?	?	n/a	---	---	---	---
F450 SUPER DUTY EARLY	4x2	All	Yes	Chassis	All	All	All	10001	67982	7	---	---	---	---	---	---	?	?	n/a	---	---	---	---
F450 SUPER DUTY LATE	4x4	All	Yes	Chassis	All	All	All	8501	3249	7	---	---	---	---	---	---	?	?	n/a	---	---	---	---
F450 SUPER DUTY LATE	4x2	All	Yes	Chassis	All	All	All	10001	3249	7	---	---	---	---	---	---	?	?	n/a	---	---	---	---
F550 SUPER DUTY EARLY	4x4	All	Yes	Chassis	All	All	All	8501	67982	2,7	---	---	---	---	---	---	?	?	n/a	---	---	---	---
F550 SUPER DUTY EARLY	4x2	All	Yes	Chassis	All	All	All	10001	67982	7	---	---	---	---	---	---	?	?	n/a	---	---	---	---
F550 SUPER DUTY LATE	4x4	All	Yes	Chassis	All	All	All	8501	3249	7	---	---	---	---	---	---	?	?	n/a	---	---	---	---
F550 SUPER DUTY LATE	4x2	All	Yes	Chassis	All	All	All	10001	3249	7	---	---	---	---	---	---	?	?	n/a	---	---	---	---
F650	4x2	All	Yes	Chassis	All	All	All	10001	2B use 8439 & 26640 or HB5 use 8436 & 26640	n/a	---	---	---	---	---	---	---	---	62275	---	?	?	

Notes:
 1. Ballast amounts are based on a "Representative Vehicle," defined in the vehicle selection guide instructions, and must be modified for all other configurations for axle and GVWR compliance.

2. Recommended snowplow prep package whenever available.
 7. "EARLY" indicates a build date before 12-01-2003, "LATE" indicates a build date on or after 12-01-2003.

2004 Ford

Section 3 MVP® & MVP PLUS™ Blades

MVP®	MVP PLUS™					
8'-6" STEEL	7'-6" STEEL	7'-6" POLY	8'-6" STEEL	8'-6" POLY	9'-6" STEEL	9'-6" POLY
IUMV85	IUTHVPP75	IUTHVPPY75	IUTHVPP85	IUTHVPPY85	IUTHVPP95	IUTHVPPY95
Blade Assembly 63819	44475	44575	44485	44585	44495	44595
AQ&L Assembly Box 1 63910	44225					
AQ&L Assembly Box 2 67951-2						
Hydraulic Kit 64777						
Light Kit 28800						
Choose a Joystick Control or Hand-Held Control	96369	96700				96600

Model	Body Style	DRW	Box Option	Engine Type	Min F G A W R	Min R G A W R	Min G V W R	Harness Kit	UltraMount® system		H13 use 28400	64500	3	---	---	1000	---	---	---	---		
									Mount Kit	Notes												
F150	4x4	Reg Cab	No	8.0 Box	5.4L V8	4300	4900	8200														
F150	4x4	Reg Cab	No	8.0 Box	5.4L V8	4300	4800	8200														
F250 SUPER DUTY EARLY	4x4	Reg Cab	No	8.0 Box	5.4L V8	5200	6084	8800														
F250 SUPER DUTY EARLY	4x4	Reg Cab	No	8.0 Box	5.4L V8	4800	6084	8800														
F250 SUPER DUTY EARLY	4x4	Reg Cab	No	8.0 Box	6.0L D	5200	6084	8800														
F250 SUPER DUTY EARLY	4x4	Reg Cab	No	8.0 Box	6.8L V10	5200	6084	8800														
F250 SUPER DUTY EARLY	4x4	Reg Cab	No	8.0 Box	6.8L V10	4800	6084	8800														
F250 SUPER DUTY EARLY	4x4	Super Cab	No	6.8 Box	5.4L V8	5200	6084	8800														
F250 SUPER DUTY EARLY	4x4	Super Cab	No	6.8 Box	5.4L V8	4800	6084	8800														
F250 SUPER DUTY EARLY	4x4	Super Cab	No	6.8 Box	6.8L V10	5200	6084	8800														
F250 SUPER DUTY EARLY	4x4	Super Cab	No	6.8 Box	6.8L V10	4800	6084	8800														
F250 SUPER DUTY EARLY	4x4	Super Cab	No	8.0 Box	5.4L V8	5200	6084	8800														
F250 SUPER DUTY EARLY	4x4	Super Cab	No	8.0 Box	5.4L V8	4800	6084	8800														
F250 SUPER DUTY EARLY	4x4	Super Cab	No	8.0 Box	6.8L V10	5200	6084	8800														
F250 SUPER DUTY EARLY	4x4	Super Cab	No	8.0 Box	6.8L V10	4800	6084	8800														
F250 SUPER DUTY EARLY	4x4	Crew Cab	No	6.8 Box	5.4L V8	5200	6084	8800														
F250 SUPER DUTY EARLY	4x4	Crew Cab	No	6.8 Box	5.4L V8	4800	6084	8800														
F250 SUPER DUTY EARLY	4x4	Crew Cab	No	6.8 Box	6.8L V10	5200	6084	8800														
F250 SUPER DUTY EARLY	4x4	Crew Cab	No	6.8 Box	6.8L V10	4800	6084	8800														
F250 SUPER DUTY EARLY	4x4	Crew Cab	No	8.0 Box	5.4L V8	5200	6084	8800														
F250 SUPER DUTY EARLY	4x4	Crew Cab	No	8.0 Box	5.4L V8	4800	6084	8800														
F250 SUPER DUTY EARLY	4x4	Crew Cab	No	8.0 Box	6.8L V10	5200	6084	8800														
F250 SUPER DUTY EARLY	4x4	Crew Cab	No	8.0 Box	6.8L V10	4800	6084	8800														
F250 SUPER DUTY EARLY	4x4	Crew Cab	No	8.0 Box	5.4L V8	5200	6084	8800														
F250 SUPER DUTY EARLY	4x4	Crew Cab	No	8.0 Box	5.4L V8	4800	6084	8800														
F250 SUPER DUTY EARLY	4x4	Crew Cab	No	8.0 Box	6.8L V10	5200	6084	8800														
F250 SUPER DUTY EARLY	4x4	Crew Cab	No	8.0 Box	6.8L V10	4800	6084	8800														
F250 SUPER DUTY EARLY	4x4	Crew Cab	No	8.0 Box	5.4L V8	5200	6084	8800														
F250 SUPER DUTY EARLY	4x4	Crew Cab	No	8.0 Box	5.4L V8	4800	6084	8800														
F250 SUPER DUTY EARLY	4x4	Crew Cab	No	8.0 Box	6.8L V10	5200	6084	8800														
F250 SUPER DUTY EARLY	4x4	Crew Cab	No	8.0 Box	6.8L V10	4800	6084	8800														
F250 SUPER DUTY EARLY	4x4	Crew Cab	No	8.0 Box	5.4L V8	5200	6084	8800														
F250 SUPER DUTY EARLY	4x4	Crew Cab	No	8.0 Box	5.4L V8	4800	6084	8800														
F250 SUPER DUTY EARLY	4x4	Crew Cab	No	8.0 Box	6.8L V10	5200	6084	8800														
F250 SUPER DUTY EARLY	4x4	Crew Cab	No	8.0 Box	6.8L V10	4800	6084	8800														
F250 SUPER DUTY EARLY	4x4	Crew Cab	No	8.0 Box	5.4L V8	5200	6084	8800														
F250 SUPER DUTY EARLY	4x4	Crew Cab	No	8.0 Box	5.4L V8	4800	6084	8800														
F250 SUPER DUTY EARLY	4x4	Crew Cab	No	8.0 Box	6.8L V10	5200	6084	8800														
F250 SUPER DUTY EARLY	4x4	Crew Cab	No	8.0 Box	6.8L V10	4800	6084	8800														
F250 SUPER DUTY EARLY	4x4	Crew Cab	No	8.0 Box	5.4L V8	5200	6084	8800														
F250 SUPER DUTY EARLY	4x4	Crew Cab	No	8.0 Box	5.4L V8	4800	6084	8800														
F250 SUPER DUTY EARLY	4x4	Crew Cab	No	8.0 Box	6.8L V10	5200	6084	8800														
F250 SUPER DUTY EARLY	4x4	Crew Cab	No	8.0 Box	6.8L V10	4800	6084	8800														
F250 SUPER DUTY EARLY	4x4	Crew Cab	No	8.0 Box	5.4L V8	5200	6084	8800														
F250 SUPER DUTY EARLY	4x4	Crew Cab	No	8.0 Box	5.4L V8	4800	6084	8800														
F250 SUPER DUTY EARLY	4x4	Crew Cab	No	8.0 Box	6.8L V10	5200	6084	8800														
F250 SUPER DUTY EARLY	4x4	Crew Cab	No	8.0 Box	6.8L V10	4800	6084	8800														
F250 SUPER DUTY EARLY	4x4	Crew Cab	No	8.0 Box	5.4L V8	5200	6084	8800														
F250 SUPER DUTY EARLY	4x4	Crew Cab	No	8.0 Box	5.4L V8	4800	6084	8800														
F250 SUPER DUTY EARLY	4x4	Crew Cab	No	8.0 Box	6.8L V10	5200	6084	8800														
F250 SUPER DUTY EARLY	4x4	Crew Cab	No	8.0 Box	6.8L V10	4800	6084	8800														
F250 SUPER DUTY EARLY	4x4	Crew Cab	No	8.0 Box	5.4L V8	5200	6084	8800														
F250 SUPER DUTY EARLY	4x4	Crew Cab	No	8.0 Box	5.4L V8	4800	6084	8800														
F250 SUPER DUTY EARLY	4x4	Crew Cab	No	8.0 Box	6.8L V10	5200	6084	8800														
F250 SUPER DUTY EARLY	4x4	Crew Cab	No	8.0 Box	6.8L V10	4800	6084	8800														
F250 SUPER DUTY EARLY	4x4	Crew Cab	No	8.0 Box	5.4L V8	5200	6084	8800														
F250 SUPER DUTY EARLY	4x4	Crew Cab	No	8.0 Box	5.4L V8	4800	6084	8800														
F250 SUPER DUTY EARLY	4x4	Crew Cab	No	8.0 Box	6.8L V10	5200	6084	8800														
F250 SUPER DUTY EARLY	4x4	Crew Cab	No	8.0 Box	6.8L V10	4800	6084	8800														
F250 SUPER DUTY EARLY	4x4	Crew Cab	No	8.0 Box	5.4L V8	5200	6084	8800														
F250 SUPER DUTY EARLY	4x4	Crew Cab	No	8.0 Box	5.4L V8	4800	6084	8800														
F250 SUPER DUTY EARLY	4x4	Crew Cab	No	8.0 Box	6.8L V10	5200	6084	8800														
F250 SUPER DUTY EARLY	4x4	Crew Cab	No	8.0 Box	6.8L V10	4800	6084	8800														
F250 SUPER DUTY EARLY	4x4	Crew Cab	No	8.0 Box	5.4L V8	5200	6084	8800														
F250 SUPER DUTY EARLY	4x4	Crew Cab	No	8.0 Box	5.4L V8	4800	6084	8800														
F250 SUPER DUTY EARLY	4x4	Crew Cab	No	8.0 Box	6.8L V10	5200	6084	8800														
F250 SUPER DUTY EARLY	4x4	Crew Cab	No	8.0 Box	6.8L V10	4800	6084	8800														
F250 SUPER DUTY EARLY	4x4	Crew Cab	No	8.0 Box	5.4L V8	5200	6084	8800														
F250 SUPER DUTY EARLY	4x4	Crew Cab	No	8.0 Box	5.4L V8	4800	6084	8800														
F250 SUPER DUTY EARLY	4x4	Crew Cab	No	8.0 Box	6.8L V10	5200	6084	8800														
F250 SUPER DUTY EARLY	4x4	Crew Cab	No	8.0 Box	6.8L V10	4800	6084	8800														
F250 SUPER DUTY EARLY	4x4	Crew Cab	No	8.0 Box	5.4L V8	5200	6084	8800														
F250 SUPER DUTY EARLY	4x4	Crew Cab	No	8.0 Box	5.4L V8	4800	6084	8800														
F250 SUPER DUTY EARLY	4x4	Crew Cab	No	8.0 Box	6.8L V10	5200	6084	8800														
F250 SUPER DUTY EARLY	4x4	Crew Cab	No	8.0 Box	6.8L V10	4800	6084	8800														
F250 SUPER DUTY EARLY	4x4	Crew Cab	No	8.0 Box	5.4L V8	5200	6084	8800														
F250 SUPER DUTY EARLY	4x4	Crew Cab	No	8.0 Box	5.4L V8	4800	6084	8800														
F250 SUPER DUTY EARLY	4x4	Crew Cab	No	8.0 Box	6.8L V10	5200	6084	8800														
F250 SUPER DUTY EARLY	4x4	Crew Cab	No	8.0 Box	6.8L V10	4800	6084	8800														

2004 Ford

Section 3 MVP® & MVP PLUS™ Blades

MVP®	MVP PLUS™					
8'-6" STEEL	7'-6" STEEL	7'-6" POLY	8'-6" STEEL	8'-6" POLY	9'-6" STEEL	9'-6" POLY
IUMV85	IUTHVPP75	IUTHVPP75	IUTHVPP85	IUTHVPP85	IUTHVPP95	IUTHVPP95
Blade Assembly	63819	44475	44575	44485	44585	44495
AQ&L Assembly Box 1	63910					
AQ&L Assembly Box 2	67951-2					
Hydraulic Kit	64777	44225				
Light Kit	28800					
Choose a Joystick Control or Hand-Held Control	96369	96700				
	96462	96600				

Model	Body Style	DRW	Box Option	Engine Type	Min F G A W R	Min R G A W R	Min G V W R	Harness Kit	UltraMount® system		Blade Assembly						
									Mount Kit	Notes	63819	63910	67951-2	64777	28800	96369	96462
F350 SUPER DUTY EARLY	4x4	Reg Cab	No	8.0 Box	5.4L V8	5200	6830	9900	67982	2,7	550	450	450	500	450	600	550
F350 SUPER DUTY EARLY	4x4	Reg Cab	No	8.0 Box	5.4L V8	5200	6830	9700	67982	2,7	550	450	400	500	450	600	550
F350 SUPER DUTY EARLY	4x4	Reg Cab	No	8.0 Box	5.4L V8	4800	6830	9900	67982	2,7	550	450	450	500	450	---	800
F350 SUPER DUTY EARLY	4x4	Reg Cab	No	8.0 Box	5.4L V8	4800	6830	9700	67982	2,7	550	450	400	500	450	900	650
F350 SUPER DUTY EARLY	4x4	Reg Cab	No	8.0 Box	6.0L D	5200	6830	9900	67982	2,7	---	950	800	---	---	---	---
F350 SUPER DUTY EARLY	4x4	Reg Cab	No	8.0 Box	6.0L D	5200	6830	9700	67982	2,7	---	850	700	---	950	---	---
F350 SUPER DUTY EARLY	4x4	Reg Cab	No	8.0 Box	6.8L V10	5200	6830	9900	67982	2,7	600	500	500	550	550	650	650
F350 SUPER DUTY EARLY	4x4	Reg Cab	No	8.0 Box	6.8L V10	5200	6830	9700	67982	2,7	600	500	450	550	500	650	600
F350 SUPER DUTY EARLY	4x4	Reg Cab	No	8.0 Box	6.8L V10	4800	6830	9900	67982	2,7	---	550	500	850	650	---	---
F350 SUPER DUTY EARLY	4x4	Reg Cab	No	8.0 Box	6.8L V10	4800	6830	9700	67982	2,7	950	500	450	700	500	---	---
F350 SUPER DUTY EARLY	4x4	Reg Cab	Yes	8.0 Box	5.4L V8	5200	8250	11200	67982	2,7	400	---	---	350	300	450	400
F350 SUPER DUTY EARLY	4x4	Reg Cab	Yes	8.0 Box	5.4L V8	5200	8250	11000	67982	2,7	400	---	---	350	350	450	450
F350 SUPER DUTY EARLY	4x4	Reg Cab	Yes	8.0 Box	5.4L V8	4800	8250	11200	67982	2,7	1000	---	---	750	550	---	---
F350 SUPER DUTY EARLY	4x4	Reg Cab	Yes	8.0 Box	6.8L V10	5200	8250	11200	67982	2,7	400	---	---	350	300	450	400
F350 SUPER DUTY EARLY	4x4	Reg Cab	Yes	8.0 Box	6.8L V10	5200	8250	11000	67982	2,7	400	---	---	350	300	700	450
F350 SUPER DUTY EARLY	4x4	Reg Cab	Yes	8.0 Box	6.8L V10	4800	8250	11200	67982	2,7	---	---	---	---	900	---	---
F350 SUPER DUTY EARLY	4x4	Super Cab	No	6.8 Box	5.4L V8	5200	6830	9900	67982	2,7	500	400	350	450	400	550	500
F350 SUPER DUTY EARLY	4x4	Super Cab	No	6.8 Box	5.4L V8	5200	6830	9700	67982	2,7	500	400	350	400	400	500	500
F350 SUPER DUTY EARLY	4x4	Super Cab	No	6.8 Box	5.4L V8	4800	6830	9900	67982	2,7	800	400	350	600	400	---	1000
F350 SUPER DUTY EARLY	4x4	Super Cab	No	6.8 Box	5.4L V8	4800	6830	9700	67982	2,7	700	400	350	450	400	---	900
F350 SUPER DUTY EARLY	4x4	Super Cab	No	6.8 Box	6.0L D	5200	6830	9900	67982	2,7	---	---	1000	---	---	---	---
F350 SUPER DUTY EARLY	4x4	Super Cab	No	6.8 Box	6.0L D	5200	6830	9700	67982	2,7	---	1000	900	---	---	---	---
F350 SUPER DUTY EARLY	4x4	Super Cab	No	6.8 Box	6.8L V10	5200	6830	9900	67982	2,7	550	450	450	500	500	600	600
F350 SUPER DUTY EARLY	4x4	Super Cab	No	6.8 Box	6.8L V10	5200	6830	9700	67982	2,7	550	450	450	500	450	600	550
F350 SUPER DUTY EARLY	4x4	Super Cab	No	6.8 Box	6.8L V10	4800	6830	9900	67982	2,7	---	850	700	---	950	---	---
F350 SUPER DUTY EARLY	4x4	Super Cab	No	6.8 Box	6.8L V10	4800	6830	9700	67982	2,7	---	700	600	1000	800	---	---
F350 SUPER DUTY EARLY	4x4	Super Cab	No	8.0 Box	5.4L V8	5200	6830	9900	67982	2,7	500	400	400	450	450	550	550
F350 SUPER DUTY EARLY	4x4	Super Cab	No	8.0 Box	5.4L V8	5200	6830	9700	67982	2,7	500	400	400	450	400	550	500
F350 SUPER DUTY EARLY	4x4	Super Cab	No	8.0 Box	5.4L V8	4800	6830	9900	67982	2,7	---	850	700	---	1000	---	---
F350 SUPER DUTY EARLY	4x4	Super Cab	No	8.0 Box	5.4L V8	4800	6830	9700	67982	2,7	---	700	550	---	850	---	---
F350 SUPER DUTY EARLY	4x4	Super Cab	No	8.0 Box	6.8L V10	5200	6830	9900	67982	2,7	550	500	450	500	500	750	600
F350 SUPER DUTY EARLY	4x4	Super Cab	No	8.0 Box	6.8L V10	5200	6830	9700	67982	2,7	550	450	450	500	500	600	600
F350 SUPER DUTY EARLY	4x4	Super Cab	Yes	8.0 Box	5.4L V8	5200	8250	11200	67982	2,7	350	---	---	300	250	400	350
F350 SUPER DUTY EARLY	4x4	Super Cab	Yes	8.0 Box	5.4L V8	5200	8250	11000	67982	2,7	400	---	---	300	250	900	650
F350 SUPER DUTY EARLY	4x4	Super Cab	Yes	8.0 Box	6.8L V10	5200	8250	11200	67982	2,7	400	---	---	300	250	950	700
F350 SUPER DUTY EARLY	4x4	Super Cab	Yes	8.0 Box	6.8L V10	5200	8250	11000	67982	2,7	---	---	---	800	600	---	---

- Notes:**
- Ballast amounts are based on a "Representative Vehicle," defined in the vehicle selection guide instructions, and must be modified for all other configurations for axle and GVWR compliance.
 - Recommended snowplow prep package whenever available.
 - "EARLY" indicates a build date before 12-01-2003, "LATE" indicates a build date on or after 12-01-2003.

2004 Ford

Section 3 MVP® & MVP PLUS™ Blades

MVP®	MVP PLUS™					
8'-6" STEEL	7'-6" STEEL	7'-6" POLY	8'-6" STEEL	8'-6" POLY	9'-6" STEEL	9'-6" POLY
IUMVP85	IUTHMPP75	IUTHMPPY75	IUTHMVP85	IUTHMPPY85	IUTHMPP95	IUTHMPPY95
Blade Assembly	63819	44475	44575	44485	44585	44495
AQ&L Assembly Box 1	63910					44225
AQ&L Assembly Box 2	67951-2					
Hydraulic Kit	64777					
Light Kit	28800					
Choose a Joystick Control or Hand-Held Control	96369					96700
	96462					96600

Model	Body Style	DRW	Box Option	Engine Type	Min F G A W R	Min R G A W R	Min G V W R	Harness Kit	UltraMount® system		PLOW						
									Mount Kit	Notes	63819	44475	44575	44485	44585	44495	44595
F350 SUPER DUTY EARLY	4x4	Crew Cab	No	6.8 Box	5.4L V8	5200	6830	9900	67982	2,7	450	350	350	400	400	500	450
F350 SUPER DUTY EARLY	4x4	Crew Cab	No	6.8 Box	5.4L V8	5200	6830	9700	67982	2,7	450	350	350	400	350	500	450
F350 SUPER DUTY EARLY	4x4	Crew Cab	No	6.8 Box	5.4L V8	4800	6830	9900	67982	2,7	---	850	700	---	950	---	---
F350 SUPER DUTY EARLY	4x4	Crew Cab	No	6.8 Box	5.4L V8	4800	6830	9700	67982	2,7	---	700	550	1000	800	---	---
F350 SUPER DUTY EARLY	4x4	Crew Cab	No	6.8 Box	6.8L V10	5200	6830	9900	67982	2,7	450	350	350	400	400	500	450
F350 SUPER DUTY EARLY	4x4	Crew Cab	No	6.8 Box	6.8L V10	5200	6830	9700	67982	2,7	450	350	350	400	350	500	450
F350 SUPER DUTY EARLY	4x4	Crew Cab	No	6.8 Box	6.8L V10	4800	6830	9900	67982	2,7	---	850	700	---	950	---	---
F350 SUPER DUTY EARLY	4x4	Crew Cab	No	6.8 Box	6.8L V10	4800	6830	9700	67982	2,7	---	700	550	1000	800	---	---
F350 SUPER DUTY EARLY	4x4	Crew Cab	No	8.0 Box	5.4L V8	5200	6830	9900	67982	2,7	450	400	350	400	400	600	500
F350 SUPER DUTY EARLY	4x4	Crew Cab	No	8.0 Box	5.4L V8	5200	6830	9700	67982	2,7	450	350	350	400	400	500	500
F350 SUPER DUTY EARLY	4x4	Crew Cab	No	8.0 Box	6.8L V10	5200	6830	9900	67982	2,7	750	450	400	500	450	---	1000
F350 SUPER DUTY EARLY	4x4	Crew Cab	No	8.0 Box	6.8L V10	5200	6830	9700	67982	2,7	600	450	400	450	450	---	850
F350 SUPER DUTY EARLY	4x4	Crew Cab	Yes	6.8 Box	6.8L V10	5200	8250	11500	67982	2,7	450	---	---	300	250	900	700
F350 SUPER DUTY EARLY	4x4	Crew Cab	Yes	6.8 Box	6.8L V10	5200	8250	11200	67982	2,7	450	---	---	300	250	900	700
F350 SUPER DUTY EARLY	4x4	Crew Cab	Yes	6.8 Box	6.8L V10	5200	8250	11000	67982	2,7	450	---	---	300	250	900	700
F350 SUPER DUTY EARLY	4x4	Crew Cab	Yes	8.0 Box	6.8L V10	5200	8250	11500	67982	2,7	900	---	---	650	500	---	---
F350 SUPER DUTY EARLY	4x4	Crew Cab	Yes	8.0 Box	6.8L V10	5200	8250	11200	67982	2,7	900	---	---	650	500	---	---
F350 SUPER DUTY EARLY	4x4	Crew Cab	Yes	8.0 Box	6.8L V10	5200	8250	11000	67982	2,7	900	---	---	650	500	---	---
F350 SUPER DUTY EARLY	4x4	All	No	Chassis	All	All	All	8501	67982	2,7	?	?	?	?	?	?	?
F350 SUPER DUTY EARLY	4x4	All	Yes	Chassis	All	All	All	8501	67982	2,7	?	?	?	?	?	?	?
F350 SUPER DUTY LATE	4x4	Reg Cab	No	8.0 Box	5.4L V8	5200	6830	9900	3249	7	550	450	400	500	450	600	550
F350 SUPER DUTY LATE	4x4	Reg Cab	No	8.0 Box	5.4L V8	5200	6830	9700	3249	7	550	450	400	450	450	600	550
F350 SUPER DUTY LATE	4x4	Reg Cab	No	8.0 Box	5.4L V8	4800	6830	9900	3249	7	550	450	400	500	450	1000	750
F350 SUPER DUTY LATE	4x4	Reg Cab	No	8.0 Box	5.4L V8	4800	6830	9700	3249	7	550	450	400	450	450	850	650
F350 SUPER DUTY LATE	4x4	Reg Cab	No	8.0 Box	6.0L D	5200	6830	9900	3249	7	---	950	800	---	---	---	---
F350 SUPER DUTY LATE	4x4	Reg Cab	No	8.0 Box	6.0L D	5200	6830	9700	3249	7	---	800	650	---	900	---	---
F350 SUPER DUTY LATE	4x4	Reg Cab	No	8.0 Box	6.8L V10	5200	6830	9900	3249	7	600	500	500	550	500	650	650
F350 SUPER DUTY LATE	4x4	Reg Cab	No	8.0 Box	6.8L V10	5200	6830	9700	3249	7	600	500	450	550	500	650	600
F350 SUPER DUTY LATE	4x4	Reg Cab	No	8.0 Box	6.8L V10	4800	6830	9900	3249	7	---	500	500	800	650	---	---
F350 SUPER DUTY LATE	4x4	Reg Cab	No	8.0 Box	6.8L V10	4800	6830	9700	3249	7	950	500	450	650	500	---	---
F350 SUPER DUTY LATE	4x4	Reg Cab	Yes	8.0 Box	5.4L V8	5200	8250	11200	3249	7	400	---	---	350	300	450	400
F350 SUPER DUTY LATE	4x4	Reg Cab	Yes	8.0 Box	5.4L V8	5200	8250	11000	3249	7	400	---	---	350	300	450	400
F350 SUPER DUTY LATE	4x4	Reg Cab	Yes	8.0 Box	5.4L V8	4800	8250	11200	3249	7	1000	---	---	750	550	---	---
F350 SUPER DUTY LATE	4x4	Reg Cab	Yes	8.0 Box	6.8L V10	5200	8250	11200	3249	7	400	---	---	350	300	450	400
F350 SUPER DUTY LATE	4x4	Reg Cab	Yes	8.0 Box	6.8L V10	5200	8250	11000	3249	7	400	---	---	350	300	650	450
F350 SUPER DUTY LATE	4x4	Reg Cab	Yes	8.0 Box	6.8L V10	4800	8250	11200	3249	7	---	---	---	---	850	---	---

- Notes:**
- Ballast amounts are based on a "Representative Vehicle," defined in the vehicle selection guide instructions, and must be modified for all other configurations for axle and GVWR compliance.
 - Recommended snowplow prep package whenever available.
 - "EARLY" indicates a build date before 12-01-2003, "LATE" indicates a build date on or after 12-01-2003.

2004 Ford

Section 3 MVP® & MVP PLUS™ Blades

MVP®		MVP PLUS™				
8'-6" STEEL	7'-6" STEEL	7'-6" POLY	8'-6" STEEL	8'-6" POLY	9'-6" STEEL	9'-6" POLY
IUMV85	IUTHVPP75	IUTHVPPY75	IUTHVPP85	IUTHVPPY85	IUTHVPP95	IUTHVPPY95
Blade Assembly 63819	44475	44575	44485	44585	44495	44595
AQ&L Assembly Box 1 63910	44225					
AQ&L Assembly Box 2 67951-2						
Hydraulic Kit 64777						
Light Kit 28800						
Choose a Joystick Control or Hand-Held Control	96369					96700
	96462					96600

Model	Body Style	DRW	Box Option	Engine Type	Min FAWR	Min R GAWR	Min GVWR	Harness Kit	UltraMount® system		PLOW						
									Mount Kit	Notes	Blade Assembly	AQ&L Assembly Box 1	AQ&L Assembly Box 2	Hydraulic Kit	Light Kit	Joystick Control	Hand-Held Control
F350 SUPER DUTY LATE	4x4	Super Cab	No	6.8 Box	5.4L V8	5200	6830	9900	3249	7	500	400	350	450	400	550	500
F350 SUPER DUTY LATE	4x4	Super Cab	No	6.8 Box	5.4L V8	5200	6830	9700	3249	7	450	400	350	400	400	500	500
F350 SUPER DUTY LATE	4x4	Super Cab	No	6.8 Box	5.4L V8	4800	6830	9900	3249	7	800	400	350	550	400	---	1000
F350 SUPER DUTY LATE	4x4	Super Cab	No	6.8 Box	5.4L V8	4800	6830	9700	3249	7	650	400	350	450	400	---	850
F350 SUPER DUTY LATE	4x4	Super Cab	No	6.8 Box	6.0L D	5200	6830	9900	3249	7	---	---	1000	---	---	---	---
F350 SUPER DUTY LATE	4x4	Super Cab	No	6.8 Box	6.0L D	5200	6830	9700	3249	7	---	1000	850	---	---	---	---
F350 SUPER DUTY LATE	4x4	Super Cab	No	6.8 Box	6.8L V10	5200	6830	9900	3249	7	550	450	450	500	500	600	550
F350 SUPER DUTY LATE	4x4	Super Cab	No	6.8 Box	6.8L V10	5200	6830	9700	3249	7	550	450	400	500	450	600	550
F350 SUPER DUTY LATE	4x4	Super Cab	No	6.8 Box	6.8L V10	4800	6830	9900	3249	7	---	850	700	---	950	---	---
F350 SUPER DUTY LATE	4x4	Super Cab	No	6.8 Box	6.8L V10	4800	6830	9700	3249	7	---	700	550	950	800	---	---
F350 SUPER DUTY LATE	4x4	Super Cab	No	8.0 Box	5.4L V8	5200	6830	9900	3249	7	500	400	400	450	450	550	550
F350 SUPER DUTY LATE	4x4	Super Cab	No	8.0 Box	5.4L V8	5200	6830	9700	3249	7	500	400	400	450	400	550	500
F350 SUPER DUTY LATE	4x4	Super Cab	No	8.0 Box	5.4L V8	4800	6830	9900	3249	7	---	850	650	---	950	---	---
F350 SUPER DUTY LATE	4x4	Super Cab	No	8.0 Box	5.4L V8	4800	6830	9700	3249	7	---	700	500	1000	800	---	---
F350 SUPER DUTY LATE	4x4	Super Cab	No	8.0 Box	6.8L V10	5200	6830	9900	3249	7	550	450	450	500	500	750	600
F350 SUPER DUTY LATE	4x4	Super Cab	No	8.0 Box	6.8L V10	5200	6830	9700	3249	7	550	450	450	500	500	600	600
F350 SUPER DUTY LATE	4x4	Super Cab	Yes	8.0 Box	5.4L V8	5200	8250	11200	3249	7	350	---	---	250	250	400	350
F350 SUPER DUTY LATE	4x4	Super Cab	Yes	8.0 Box	5.4L V8	5200	8250	11000	3249	7	350	---	---	300	250	900	600
F350 SUPER DUTY LATE	4x4	Super Cab	Yes	8.0 Box	6.8L V10	5200	8250	11000	3249	7	1000	---	---	750	550	---	---
F350 SUPER DUTY LATE	4x4	Crew Cab	No	6.8 Box	5.4L V8	5200	6830	9900	3249	7	450	350	350	400	350	500	450
F350 SUPER DUTY LATE	4x4	Crew Cab	No	6.8 Box	5.4L V8	5200	6830	9700	3249	7	450	350	350	400	350	500	450
F350 SUPER DUTY LATE	4x4	Crew Cab	No	6.8 Box	5.4L V8	4800	6830	9700	3249	7	---	850	650	---	950	---	---
F350 SUPER DUTY LATE	4x4	Crew Cab	No	6.8 Box	6.8L V10	5200	6830	9900	3249	7	450	350	350	400	350	500	450
F350 SUPER DUTY LATE	4x4	Crew Cab	No	6.8 Box	6.8L V10	5200	6830	9700	3249	7	450	350	350	400	350	500	450
F350 SUPER DUTY LATE	4x4	Crew Cab	No	6.8 Box	6.8L V10	4800	6830	9900	3249	7	---	850	650	---	950	---	---
F350 SUPER DUTY LATE	4x4	Crew Cab	No	6.8 Box	6.8L V10	4800	6830	9700	3249	7	---	700	550	950	800	---	---
F350 SUPER DUTY LATE	4x4	Crew Cab	No	6.8 Box	6.8L V10	5200	6830	9900	3249	7	450	350	350	400	350	500	450
F350 SUPER DUTY LATE	4x4	Crew Cab	No	6.8 Box	6.8L V10	5200	6830	9700	3249	7	450	350	350	400	350	500	450
F350 SUPER DUTY LATE	4x4	Crew Cab	No	8.0 Box	5.4L V8	5200	6830	9900	3249	7	450	400	350	400	400	600	500
F350 SUPER DUTY LATE	4x4	Crew Cab	No	8.0 Box	5.4L V8	5200	6830	9700	3249	7	450	350	350	400	400	500	500
F350 SUPER DUTY LATE	4x4	Crew Cab	No	8.0 Box	6.8L V10	5200	6830	9900	3249	7	750	450	400	500	450	---	1000
F350 SUPER DUTY LATE	4x4	Crew Cab	No	8.0 Box	6.8L V10	5200	6830	9700	3249	7	600	450	400	450	450	---	850
F350 SUPER DUTY LATE	4x4	Crew Cab	Yes	6.8 Box	6.8L V10	5200	8250	11500	3249	7	450	---	---	300	250	900	650
F350 SUPER DUTY LATE	4x4	Crew Cab	Yes	6.8 Box	6.8L V10	5200	8250	11200	3249	7	450	---	---	300	250	900	650
F350 SUPER DUTY LATE	4x4	Crew Cab	Yes	6.8 Box	6.8L V10	5200	8250	11000	3249	7	450	---	---	300	250	900	650
F350 SUPER DUTY LATE	4x4	Crew Cab	Yes	8.0 Box	6.8L V10	5200	8250	11500	3249	7	900	---	---	650	450	---	---
F350 SUPER DUTY LATE	4x4	Crew Cab	Yes	8.0 Box	6.8L V10	5200	8250	11200	3249	7	900	---	---	650	450	---	---
F350 SUPER DUTY LATE	4x4	Crew Cab	Yes	8.0 Box	6.8L V10	5200	8250	11000	3249	7	900	---	---	650	450	---	---

Notes:
 1. Ballast amounts are based on a "Representative Vehicle," defined in the vehicle selection guide instructions, and must be modified for all other configurations for axle and GVWR compliance.
 7. "EARLY" indicates a build date before 12-01-2003, "LATE" indicates a build date on or after 12-01-2003.

2004 Ford

Section 3 MVP® & MVP PLUS™ Blades

UltraMount						
MVP®	MVP PLUS™					
8'-6" STEEL	7'-6" STEEL	7'-6" POLY	8'-6" STEEL	8'-6" POLY	9'-6" STEEL	9'-6" POLY
IUMVP85	IUTHVPP75	IUTHVPPY75	IUTHVPP85	IUTHVPPY85	IUTHVPP95	IUTHVPPY95
Blade Assembly	63819	44475	44575	44485	44585	44495
AQ&L Assembly Box 1	63910					
AQ&L Assembly Box 2	67951-2	44225				
Hydraulic Kit	64777					
Light Kit	28800					
Choose a Joystick Control or Hand-Held Control	96369	96700				
	96462	96600				

Model	Body Style	DRW	Box Option	Engine Type	Min FGAWR	Min RGAWR	Min GVWR	Harness Kit	UltraMount® system		?	?	?	?	?	?	?
									Mount Kit	Notes							
F350 SUPER DUTY LATE	4x4	All	No	Chassis	All	All	8501	2B use 8439 or HB5 use 8436	3249	7	?	?	?	?	?	?	?
F350 SUPER DUTY LATE	4x4	All	Yes	Chassis	All	All	8501		3249	7	?	---	---	?	?	?	?
F450 SUPER DUTY EARLY	4x4	All	Yes	Chassis	All	All	8501		67982	2,7	?	---	---	?	?	?	?
F450 SUPER DUTY EARLY	4x2	All	Yes	Chassis	All	All	10001		67982	7	?	---	---	?	?	?	?
F450 SUPER DUTY LATE	4x4	All	Yes	Chassis	All	All	8501		3249	7	?	---	---	?	?	?	?
F450 SUPER DUTY LATE	4x2	All	Yes	Chassis	All	All	10001		3249	7	?	---	---	?	?	?	?
F550 SUPER DUTY EARLY	4x4	All	Yes	Chassis	All	All	8501		67982	2,7	?	---	---	?	?	?	?
F550 SUPER DUTY EARLY	4x2	All	Yes	Chassis	All	All	10001		67982	7	?	---	---	?	?	?	?
F550 SUPER DUTY LATE	4x4	All	Yes	Chassis	All	All	8501		3249	7	?	---	---	?	?	?	?
F550 SUPER DUTY LATE	4x2	All	Yes	Chassis	All	All	10001		3249	7	?	?	---	---	?	?	?

- Notes:**
1. Ballast amounts are based on a "Representative Vehicle," defined in the vehicle selection guide instructions, and must be modified for all other configurations for axle and GVWR compliance.
 2. Recommended snowplow prep package whenever available.
 7. "EARLY" indicates a build date before 12-01-2003, "LATE" indicates a build date on or after 12-01-2003.

2004 Mazda

Section 1 Suburbanite™ & MIDWEIGHT™ Blades

	
Suburbanite™	
6'-8" POLY	7'-4" POLY
SUB68	SUB74
Plow	
Blade Assembly	27546 27548
AQ&L Assembly Box 1	27550
AQ&L Assembly Box 2	n/a
Hydraulic Kit	27516
Light Kit	64100
Choose a Joystick Control or Hand-Held Control	56369 56462

	
MIDWEIGHT™	
7'-6" STEEL	7'-6" POLY
IUTH75	IUTHY75
64340	64330
	64336
	67992
	64620
	28800
	56369
	56462

Model	4x4	CabPlus	DRW	Box Option	Engine Type	Min F G A W R	Min R G A W R	Min G V W R	Harness Kit	Personal Plow system		Ballast Guidelines, lbs (1)		UltraMount® system		Ballast Guidelines, lbs (1)	
										Mount Kit	Notes			Mount Kit	Notes		
B4000	4x4	CabPlus	No	6.0 Box	4.0L V6	2850	2600	4960	HB5 use 8436	1203	8	100	150	n/a	---	---	---
B4000	4x4	CabPlus	No	6.0 Box	4.0L V6	2710	2600	4960		1203	8	200	300	n/a	---	---	---
B4000	4x4	CabPlus4	No	6.0 Box	4.0L V6	2850	2600	4960		1203	8	100	150	n/a	---	---	---
B4000	4x4	CabPlus4	No	6.0 Box	4.0L V6	2710	2600	4960		1203	8	200	300	n/a	---	---	---

- Notes:**
- Ballast amounts are based on a "Representative Vehicle," defined in the vehicle selection guide instructions, and must be modified for all other configurations for axle and GVWR compliance.
 - These Snowplows Are For Personal/Homeowner Use Only.

2004 Nissan

Section 1 Suburbanite™ & MIDWEIGHT™ Blades

 Suburbanite™	
6'-8" POLY	7'-4" POLY
SUB68	SUB74
Plow Blade Assembly	27546 27548
AQ&L Assembly Box 1	27550
AQ&L Assembly Box 2	n/a
Hydraulic Kit	27516
Light Kit	64100
Choose a Joystick Control or Hand-Held Control	56369 56462

 UltraMount™	
MIDWEIGHT™	
7'-6" STEEL	7'-6" POLY
IUTH75	IUTHY75
64340	64330
64336	
67992	
64620	
28800	
56369	
56462	

Model	4x4	Body Style	DRW	Box Option	Engine Type	Min F G A W R	Min R G A W R	Min G V W R	Harness Kit	Personal Plow system		Ballast Guidelines, lbs (1)	UltraMount® system		Ballast Guidelines, lbs (1)		
										Mount Kit	Notes		Mount Kit	Notes			
TITAN XE	4x4	King Cab	No	6.5 Box	5.6L V8	3494	3793	6486		31303	8,40	---	50	n/a	---	---	---
TITAN XE	4x4	Crew Cab	No	6.5 Box	5.6L V8	3494	3793	6486	HB3/HB4 use 27480-1 & 28027	31303	8,40	---	50	n/a	---	---	---
TITAN SE	4x4	King Cab	No	6.5 Box	5.6L V8	3494	3793	6486		31303	8,40	---	300	n/a	---	---	---
TITAN SE	4x4	Crew Cab	No	6.5 Box	5.6L V8	3494	3793	6486		31303	8,40	---	300	n/a	---	---	---
TITAN LE	4x4	King Cab	No	6.5 Box	5.6L V8	3494	3793	6486		31303	8,40	---	450	n/a	---	---	---

- Notes:**
- Ballast amounts are based on a "Representative Vehicle," defined in the vehicle selection guide instructions, and must be modified for all other configurations for axle and GVWR compliance.
 - These Snowplows Are For Personal/Homeowner Use Only.
 - Removal of skid plate or splash guard required.

2004 Toyota

Section 1 Suburbanite™ & MIDWEIGHT™ Blades

	
Suburbanite™	
6'-8" POLY	7'-4" POLY
SUB68	SUB74
Plow	
Blade Assembly	
27546	27548
AQ&L Assembly Box 1	
27550	
AQ&L Assembly Box 2	
n/a	
Hydraulic Kit	
27516	
Light Kit	
64100	
Choose a Joystick Control or Hand-Held Control	
56369	
56462	

	
MIDWEIGHT™	
7'-6" STEEL	7'-6" POLY
IUTH75	IUTHY75
64340	64330
64336	
67992	
64620	
28800	
56369	
56462	

Model	4x4	Body Style	DRW	Box Option	Engine Type	Min F G A W R	Min R G A W R	Min G V W R	Harness Kit	Personal Plow system		Ballast Guidelines, lbs (1)	UltraMount® system		Ballast Guidelines, lbs (1)		
										Mount Kit	Notes		Mount Kit	Notes			
TACOMA	4x4	Reg Cab	No	8.0 Box	2.7L I4	2650	2800	5000	HB2 use 8439	2313	8	50	100	n/a	---	---	---
TACOMA	4x4	Ext Cab	No	6.5 Box	2.7L I4	2650	2800	5000		2313	8	50	100	n/a	---	---	---
TACOMA	4x4	Ext Cab	No	6.5 Box	3.4L V6	2650	2800	5100		2313	8	100	150	n/a	---	---	---
TACOMA	4x4	Double Cab	No	5.0 Box	3.4L V6	2650	2800	5100		2313	8	200	300	n/a	---	---	---
TUNDRA	4x4	Reg Cab	No	8.0 Box	4.7L V8	3160	3760	6300		2303	8	---	0	n/a	---	---	---
TUNDRA	4x4	Double Cab	No	6.2 Box	4.7L V8	3500	3760	6600		2303	8	---	0	n/a	---	---	---
TUNDRA SR5	4x4	Ext Cab	No	6.2 Box	4.7L V8	3160	3760	6300		2303	8	---	300	n/a	---	---	---
TUNDRA SR5	4x4	Ext Cab	No	6.2 Box	4.7L V8	3160	3760	6010		2303	8	---	350	n/a	---	---	---
TUNDRA LIMITED	4x4	Ext Cab	No	6.2 Box	4.7L V8	3160	3760	6300		2303	8	---	200	n/a	---	---	---
TUNDRA LIMITED	4x4	Ext Cab	No	6.2 Box	4.7L V8	3160	3760	6010		2303	8	---	200	n/a	---	---	---

- Notes:**
- Ballast amounts are based on a "Representative Vehicle," defined in the vehicle selection guide instructions, and must be modified for all other configurations for axle and GVWR compliance.
 - These Snowplows Are For Personal/Homeowner Use Only.

HEADLAMP REFERENCE GUIDE

NOTE: The lamp type is usually embossed in the headlamp lens.

NOTE: Blue ground wires may be LT or DK BLU, w/ or w/o WHT stripe, depending on harness.

Headlamp Type	Bulb Type	Headlamp Type	Bulb Type
LF	H4703	2E1	H6545
UF	H4701	H13	9008
1A1	H4651	HB1	9004
2A1	H4652(GMC/Chevy)	HB2	9003
2A1	H4656 (Mitsubishi)	HB3	9005
2B1	H6054	HB4	9006
2D1	H6024	HB5	9007

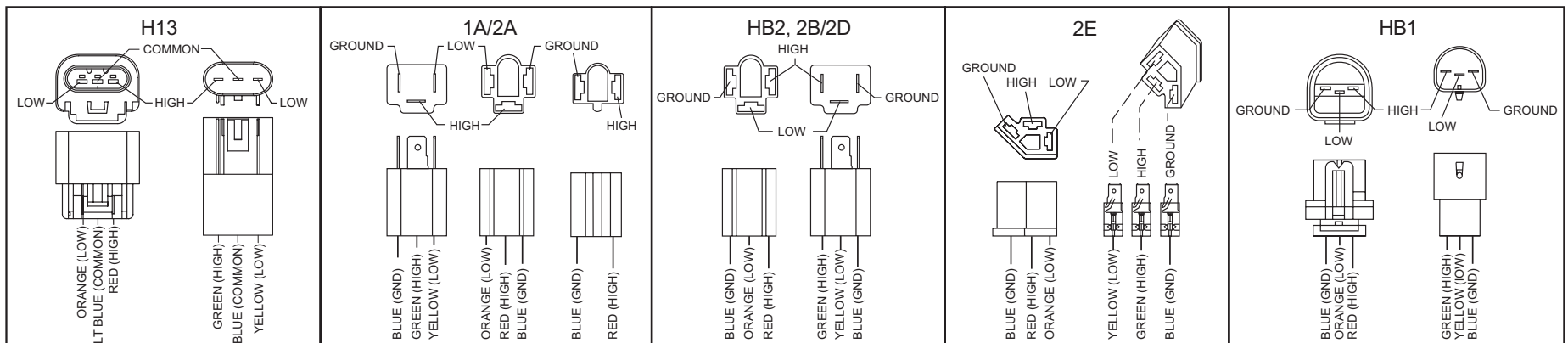
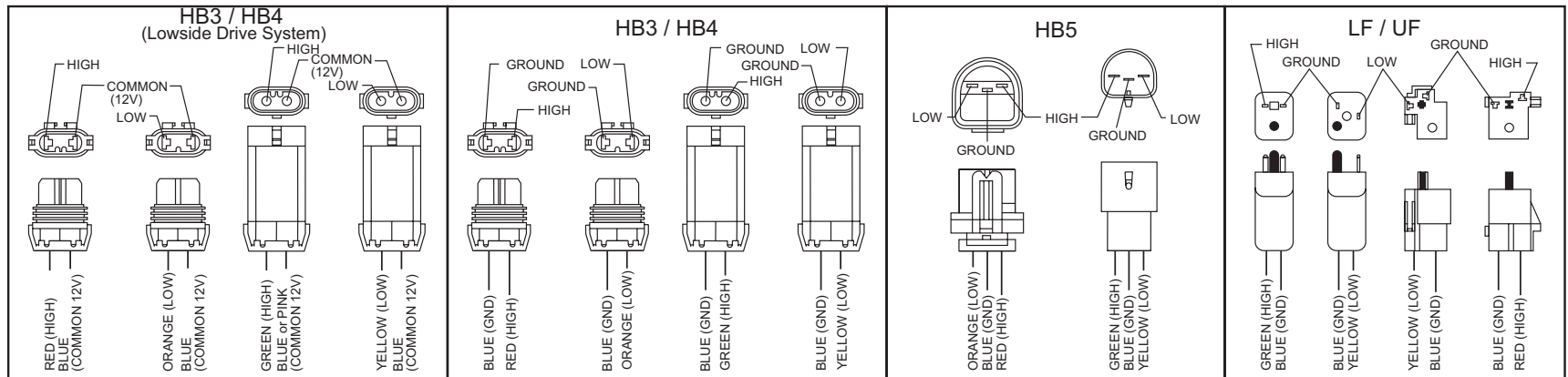

WEIGHT AND DIMENSIONAL CHARTS

Plows and Accessories Information										
Plows		Accessories – Part Number (Effective Added Weight in lb)								Var.
Size	Wt. (lb)	HD Poly Deflector	Rubber Deflector	Cutting Edge 1/2"	Back Drag Edge 1/4"	Wing Kit	Shoes	Curb Guard	Dolly Wheel	Z (in)
SUB68	239	—	—	—	—	—	27710 (5.7)	—	—	20.4
SUB74	257	—	—	—	—	—	27710 (5.7)	—	—	20.8
IUTM75	540	63700 (19.1)	62123 (29.6)	—	64758 (47.0)	—	64392 (21.1)	44404 (61.3)	—	20.4
IUTMY75	532	63700 (19.1)	62123 (29.6)	—	64758 (47.0)	—	64392 (21.1)	44404 (61.6)	—	20.3
IUTP75	682	63700 (19.2)	62123 (29.7)	49346 (25.8)	64758 (47.0)	—	—	44403 (63.8)	—	20.8
IUTPY75	719	—	—	49350 (24.8)	64758 (47.0)	—	—	44403 (58.4)	—	22.7
IUTP80	699	63670 (20.1)	62530 (33.8)	49347 (27.4)	66892 (60.6)	—	—	44403 (62.3)	—	21.3
IUTPY80	727	—	—	49351 (26.9)	66892 (60.6)	—	—	44403 (59.0)	—	22.5
IUTP85	715	63670 (21.1)	62220 (35.5)	49348 (28.8)	66999 (63.5)	—	—	44403 (61.7)	—	21.5
IUTPP75	789	63700 (12.4)	62123 (28.9)	—	64758 (59.7)	64410 (90)	—	44404 (41.2)	—	26.1
IUTPP80	805	63670 (13.3)	62530 (32.2)	—	66892 (63.2)	64410 (90)	—	44404 (40.7)	—	26.4
IUTPP85	821	63670 (14.2)	62220 (35.5)	—	66999 (66.2)	64410 (90)	—	44404 (40.3)	—	26.7
IUTPP90	837	63670 (15.0)	62220 (37.1)	—	66991 (69.2)	64410 (90)	—	44404 (39.8)	—	27.0
IMVP85	899	—	—	28409 (41.6)	—	—	—	—	—	24.0
IUTMVPP75	827	—	44278 (*)	44284 (*)	—	44276 (*)	44277 (*)	44404 (25.2)	—	18.4
IUTMVPPY75	799	—	44278 (*)	44284 (*)	—	44276 (*)	44277 (*)	44404 (25.5)	—	18.4
IUTMVPP85	880	—	44279 (*)	44285 (*)	—	44276 (*)	44277 (*)	44404 (24.0)	—	18.3
IUTMVPPY85	847	—	44279 (*)	44285 (*)	—	44276 (*)	44277 (*)	44404 (24.1)	—	18.3
IUTMVPP95	1006	—	44280 (*)	—	—	44276 (*)	44277 (*)	44404 (22.8)	—	18.8
IUTMVPPY95	964	—	44280 (*)	—	—	44276 (*)	44277 (*)	44404 (23.5)	—	18.8
IUHW90	1048	—	62220 (37.8)	—	—	—	—	44404 (33.7)	62430 (24.8)	33.0
IUHW10	1106	—	62124 (45.8)	—	—	—	—	44404 (33.1)	62430 (24.8)	33.6
—	—	UltraMount to UniMount Conversion Kit 27170 (94.0)								Varies

* This part number is currently not available for purchase, thus finalized weights have not been established. Once weights are established and product is available, finalized weights will be published.

NOTE: The addition of accessories to a snowplow or vehicle will require additional ballast above any amount published in this guide in order to maintain FMVSS compliance. Completed vehicle with additional accessories shall not exceed GVWR or GAWR.

NOTE: An abbreviation key is on page 2.

Mount Information							
Mount	Weight (lb)	X (in)	Y (in)	Mount	Weight (lb)	X (in)	Y (in)
Suburbanite™ Mounts							
1203	34.0	27.0	6.0	2313	30.0	27.0	5.0
1213-1	23.0	26.0	6.0	3713-1	20.0	26.0	5.0
1223	40.0	28.0	7.0	3723	35.0	21.4	5.0
1233	34.0	32.0	7.1	31303	43.0	27.9	4.8
1503	26.0	27.0	6.0	31543	20.0	28.5	7.1
1523	26.0	30.0	6.0	32323	36.0	30.0	7.3
1533-1	31.0	26.0	5.0	33903	45.0	31.0	7.8
2303	41.0	29.0	6.0	42021	37.0	29.0	8.0
UniMount® and UltraMount® Mounts							
1369	80.0	32.9	8.3	63760	40.0	30.0	8.0
1379	83.0	32.9	8.3	63883-2	47.0	37.0	6.9
3249	65.0	30.4	9.8	63900	87.0	29.6	12.5
3919	47.0	30.1	8.5	64110	115.0	38.0	10.0
33109	110.0	38.0	7.0	64500	33.0	32.5	8.9
33259	43.0	33.5	10.8	67810	44.0	35.1	8.7
33559	115.0	38.0	10.0	67865	41.0	31.3	7.6
33929	39.0	32.5	8.1	67960-1	34.0	29.1	7.6
30999	40.0	33.5	8	67980	51.0	35.0	8.5
62275	Varies			67981-2	54.0	32.4	11.4
63710-1	87.0	27.8	5.7	67982	69.0	30.4	9.0

NOTE: See next page for variable definitions.

DIMENSIONAL DIAGRAM

Variables:

X = Distance from center of front axle to receiver pin

Y = Distance from receiver pin to CG of mount.

Z = Distance from receiver pin to CG of snowplow.

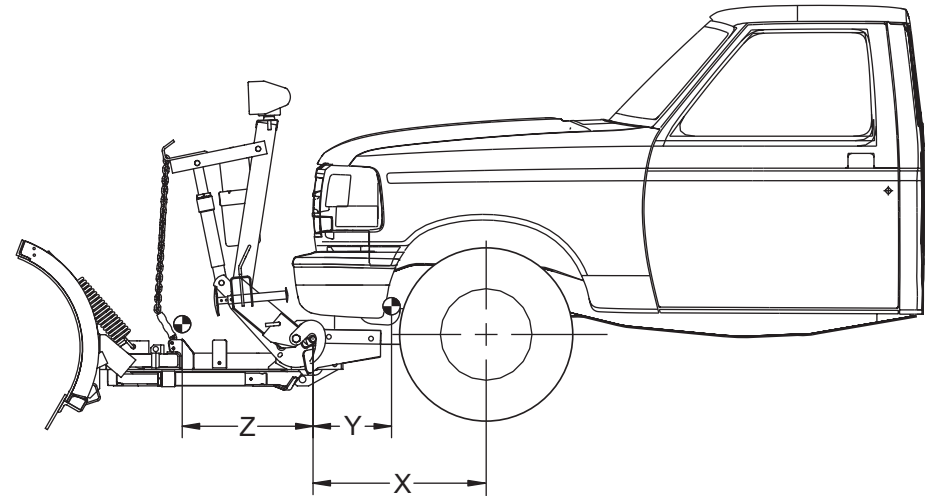

Example: Weight that one would use if they had an IUTP75 with the poly deflector and a 1/2" cutting edge.

The weight of the plow alone with no accessories would be 682 lb with its center of gravity 20.8 in from the coupling point. To add the weight of the accessories, look in the row with the IUTP75 blade to find the effective poly deflector weight of 19.2 lb and the effective cutting edge weight of 25.8 lb.

The total weight of the blade and accessories will be:

$$\begin{array}{r}
 682.0 \\
 19.2 \\
 + 25.8 \\
 \hline
 727.0
 \end{array}$$

with its center of gravity still at 20.8 in from the coupling point

ALWAYS comply with the vehicle manufacturer's stated gross vehicle and axle weight ratings (found on

the driver-side door jamb of the vehicle) and front and rear weight distribution ratio with the snowplow installed. In some cases, rear ballast may be required to achieve these requirements.

Available vehicle capacities for aftermarket equipment and components can be determined by using the above information along with information provided by the vehicle manufacturer's Body Builder Guides. Follow all requirements and recommendations as stated by vehicle manufacturer.

NOTE: An abbreviation key is on page 2.

VEHICLE AND PLOW APPLICATION INQUIRY SHEET



Western Products
7777 North 73rd Street
Milwaukee, WI 53223

Telephone (414) 354-2310
Fax (414) 354-6664

DISTRIBUTOR		TEL
		FAX

CUSTOMER		
VIN		DATE BUILT

SELECT MOUNT TYPE	<input type="checkbox"/> UniMount [®]	<input type="checkbox"/> UltraMount [®]	<input type="checkbox"/> Conversion Kit
	<input type="checkbox"/> Suburbanite [™]		

VEHICLE INFORMATION

YEAR			
MAKE			
MODEL			
DRIVE TRAIN	<input type="checkbox"/> 4x2 (over 10,000 lb. GVW only)	<input type="checkbox"/> 4x4	<input type="checkbox"/> ALL WHEEL <input type="text"/> OTHER
DRW (Dual Rear Wheels)	<input type="checkbox"/> YES	<input type="checkbox"/> NO	
BODY STYLE	<input type="checkbox"/> REG CAB	<input type="checkbox"/> EXT CAB	<input type="text"/> OTHER
BOX OPTION (S)	<input type="checkbox"/> DUMP BOX	<input type="checkbox"/> STAKE BED	<input type="text"/> OTHER
ENGINE TYPE			
GFAWR			
GRAWR			
GVWR			

HORIZONTAL DISTANCE DESCRIPTION

L31	DRIVERS hip point; in MIDDLE position, to Centerline of FRONT axle	(in.)
L101	Between axles (Wheelbase)	(in.)
L104	Middle of FRONT bumper to centerline of FRONT axle	(in.)
	Middle of ballast location to centerline of REAR axle	(in.)

VEHICLE WEIGHT (TRUCK MUST BE WEIGHED COMPLETE AND EMPTY (-) OCCUPANTS, PLOW & MOUNT)

FRONT (lb.)	REAR (lb.)

FUEL TANKS (ONLY NEEDED IF WEIGHED VEHICLE NOT FULLY FUELED)

	LEVEL (see below)	CAPACITY (gal.)	LOCATION FROM AXLE TO CENTER OF TANK(in.)
FRONT OF AXLE			
REAR OF AXLE			

FUEL LEVEL (EMPTY = 0, HALF = 1/2, FULL = 1)

THIS FORM *MUST* BE COMPLETED IN ITS ENTIRETY. ANY FORMS CONTAINING INCOMPLETE INFORMATION *WILL NOT BE CONSIDERED*. PLEASE RETURN VIA FAX (414) 354-6664.

Western Products or the vehicle manufacturer may require or recommend optional equipment for snow removal.
See the WESTERN[®] Selection List for additional product information.

UltraMount® SYSTEM TO UniMount® SYSTEM CONVERSION KIT (PN 27170)

⚠ WARNING

Conversion kit use is limited to vehicles up to 19,500 lb GVWR.

⚠ WARNING

Do not exceed GVWR or GAWR, including blade and ballast. The rating label is found on the driver-side vehicle door cornerpost.

This easy to use UltraMount system to UniMount system conversion kit enables you to attach a UniMount plow to a vehicle equipped with an UltraMount mount.

Simply remove the receivers from your UltraMount system mount, and pin the conversion plate in place. This accessory is perfect for customers with multiple snowplows, providing their fleet with versatility while changing to the UltraMount system.

This new kit is also ideal for transferring an old UniMount plow to a new truck. As new trucks are released, we will develop only new UltraMount mounts for these plow applications. This will allow the customer to transfer an existing UniMount plow to the late model vehicle. In addition, when customers are ready to replace their old UniMount plow, the truck will already have the mount and wiring for an UltraMount plow.

TO QUALIFY THE VEHICLE AND DETERMINE BALLAST, YOU MUST FILL OUT THE VEHICLE AND PLOW APPLICATION INQUIRY SHEET.

NOTE: When ballast is required, it should be secured behind the rear wheels in a manner which prevents it from sliding during normal driving. Western Products offers an options ballast retainer kit (PN 62849) for this purpose.

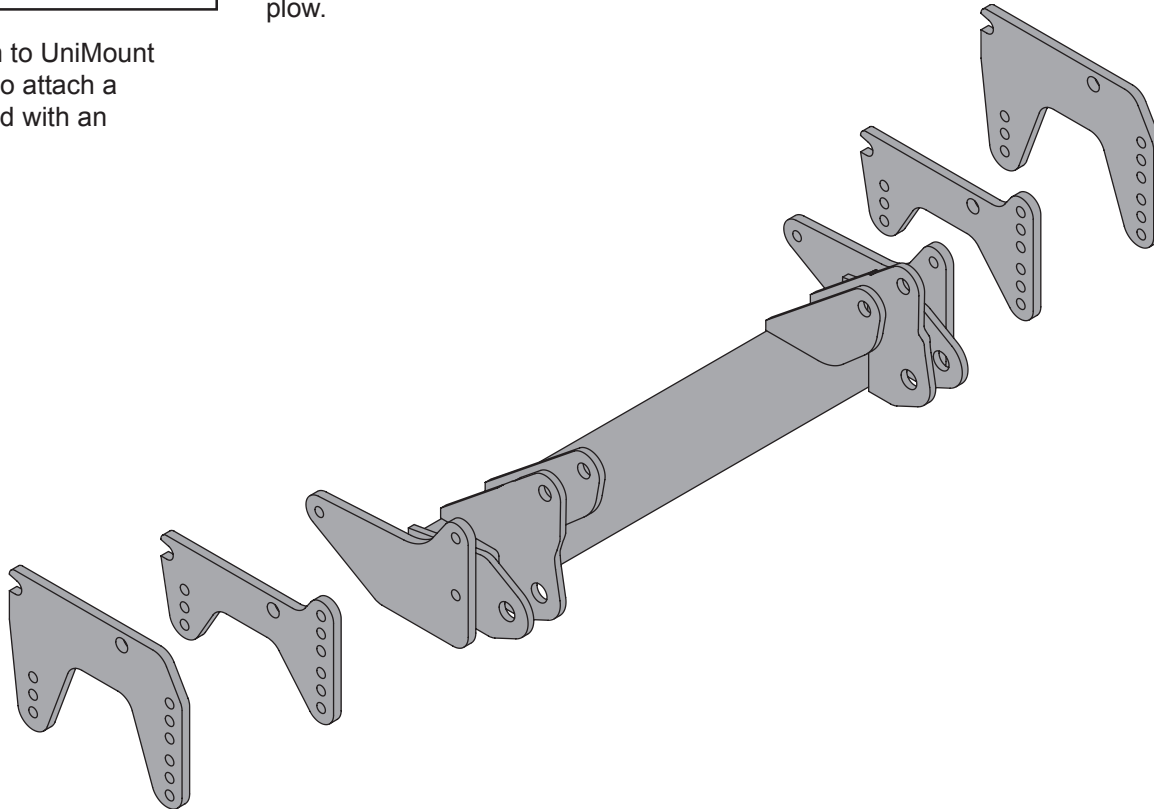

Notes:



WESTERN PRODUCTS
P.O. BOX 245038
MILWAUKEE, WI 53224-9538

 A DIVISION OF DOUGLAS DYNAMICS, L.L.C.

Western Products reserves the right under its product improvement policy to change construction or design details and furnish equipment when so altered without reference to illustrations or specifications used. Western Products or the vehicle manufacturer may require or recommend optional equipment for snow removal. Do not exceed vehicle ratings with a snowplow. Western Products offers a limited warranty for all snowplows and accessories. See separately printed page for this important information. The following are registered (®) or unregistered (™) trademarks of Douglas Dynamics, L.L.C.: MIDWEIGHT™, MVP®, MVP PLUS™, POLY PRO-PLOW®, PRO-PLOW®, PRO PLUS®, Suburbanite™, UltraMount®, UniMount®, WESTERN®.

Printed in U.S.A.