



2001

MODEL YEAR VEHICLES

SELECTION LIST

Isolation Module System Snowplows



Lit. No. 64305
June 1, 2006
Revision 07

This document supersedes all editions with an earlier date.

TABLE OF CONTENTS

About the <i>Selection List</i>	3	Mazda Attachment Kits	26
Selection Example	4	Toyota Attachment Kits	27
Chevy/GMC Attachment Kits	5	Headlamp Reference Guide	28
Dodge Attachment Kits	11	Weight and Dimensional Charts	29
Ford Attachment Kits	14	Dimensional Diagram	30
International Attachment Kits	24	Ballast Inquiry Sheet	31
Jeep Attachment Kits	25	UltraMount® System to UniMount® System Conversion Kit	32

ABBREVIATION KEY			
---	No Application	NTEA	National Truck Equipment Association
4WS	Four Wheel Steering	OEM	Original Equipment Manufacturer
4x2	Two Wheel Drive	OHC	Overhead Cam
4x4	Four Wheel Drive	PN	Part Number
A,Q&L	A-Frame, Quadrant & Lift Frame	RGAWR	Rear Gross Axle Weight Rating
AWD	All Wheel Drive	SL	Selection List
CG	Center of Gravity	SU-2DR	Two Door Sport/Utility Vehicle
Chassis	Chassis Cab or Cab Chassis	SU-4DR	Four Door Sport/Utility Vehicle
DIA	Diameter	SUB	Suburbanite™ Snowplow
DRW	Dual Rear Wheels	UHW	UniMount® Heavy Weight Snowplow
Ext Cab	Extended Cab Vehicle	UTM	UltraMount® MIDWEIGHT™ Snowplow
FFV	Flex Fuel Vehicle	UTMY	UltraMount MIDWEIGHT Poly Snowplow
FGAWR	Front Gross Axle Weight Rating	UTMVP	UltraMount MVP® Snowplow
FMVSS	Federal Motor Vehicle Safety Standards	UTMVPP	UltraMount MVP PLUS Snowplow
GVWR	Gross Vehicle Weight Rating	UTMVPPY	UltraMount Poly MVP PLUS Snowplow
HD	Heavy Duty	UTP	UltraMount PRO-PLOW® Snowplow
HO	High Output	UTPP	UltraMount PRO PLUS® Snowplow
HYD	Hydraulic	UTPY	UltraMount POLY PRO-PLOW Snowplow
MIN	Minimum	w/	With
MVP	MultiPosition V-Plow	w/o	Without
MVPP	MVP PLUS™ Snowplow		

⚠ WARNING

New untitled vehicle installation of a snowplow requires National Highway Traffic Safety Administration altered vehicle certification labeling. Installer to verify that selected snowplow and ballast, if required, do not exceed GVWR or GAWR rating label and complies with FMVSS.

⚠ WARNING

Do not exceed GVWR or GAWR, including blade and ballast. The rating label is found on the driver-side vehicle door cornerpost.

ABOUT THE SELECTION LIST

The *Selection List (SL)* is designed to help you determine the appropriate snowplow components for a particular snowplow vehicle application. The information published in this guide is based on Federal Motor Vehicle Safety Standards (FMVSS) and a "representative" snowplow vehicle as defined in this guide. The vehicle includes a combined weight of 300 lb for occupants in the front seat location.

This *SL* is for specific model year vehicles only and is listed on the front cover of this guide. This guide should be saved for future reference. New selection guides will be published for the upcoming model year and so on. The instructions on page 4 explain how to use the *Selection List*.

The "Representative Vehicle"

Knowing that today's snowplow vehicles come in a variety of sizes and configurations (such as wheel base, engine size, and handling packages), Western Products has defined a "representative vehicle" that contains the options most likely to appear on a typical snowplow application. The "representative vehicle" includes the following options:

- 4X4 Drivetrain (unless noted)
- Spare Tire & Wheel
- Automatic Transmission
- Rear Bumper
- Air Conditioning
- Full Fluids

NOTE: If the vehicle in question does not match a vehicle listing in the *Selection List*, or has options that differ from the "Representative Vehicle" as defined earlier, the ballast inquiry sheet must be filled out and submitted in order to determine plow availability and correct ballast amounts to maintain FMVSS compliance. Completed vehicle at no time shall exceed GVWR or GAWR.

Snowplow Product

Snowplows are considered motor vehicle equipment. The installer is ultimately responsible for determining and correctly labeling the vehicle with the addition of snowplow selection. No product selected and installed shall render inoperative the vehicle's safety compliance.

Product Changes

All information is as accurate as we can determine but is subject to revision with additional or more complete information. Western Products reserves the right under its product improvement policy to change construction or design details and furnish equipment when so altered without reference to illustrations or specifications used. Western Products or the vehicle manufacturer may require or recommend optional equipment for snow removal.

Ballast

When ballast is required it must be secured behind the rear wheels in a manner which prevents it from sliding during normal driving. Ballast shall not exceed 1000 lb.

Western Products offers an optional ballast retainer kit (62849) for this purpose.

HOW TO USE THE SELECTION LIST

Selection Example:

Acme Motors 15000 VX with UltraMount® System

- Go to the section for the appropriate manufacturer.
- Go to the subsection for the desired snowplow:
 - **Section 1:** Suburbanite™ & MIDWEIGHT™ snowplows
 - **Section 2:** PRO-PLOW®, PRO PLUS® & Heavy Weight snowplows
 - **Section 3:** MVP® & MVP PLUS™ snowplows
- Starting at the left-most column, find the **model** and appropriate configuration for the vehicle. In this case, 4X4, Regular Cab, 6.5 ft. box, 5.3L V8 engine, 3925 Min. FGAWR.

- Locate the **harness kit** part number for this vehicle: 27780. See Headlamp Reference Guide in the back of the Selection List for more information.
- Locate the **mount** for this vehicle: 1523 for Suburbanite™ system or 67960-1 for UltraMount® system. Refer to any footnotes concerning conditions or requirements. For this example the UltraMount system is selected and has five footnotes: 1, 2, 3, 4 and 6.
- Locate the acceptable **blades** at the top of the table. Only those blades with ballast weights listed are valid applications. Three short dashes (—) indicates an invalid application. A question mark (?) indicates a ballast inquiry sheet must be completed.

- For this example, there are two acceptable UltraMount blades. Choose the 7'-6" Steel MIDWEIGHT blade. This blade requires 350 lb of ballast.
- To order components for a complete snowplow package, read down from the top of the selected blade column for appropriate part numbers. Be sure to select *one* control, either joystick or hand-held. For this example, the part numbers would be:
 - 64340 (blade assembly)
 - 64336 (A, Q & L assembly Box 1)
 - 67992 (A, Q & L assembly Box 2)
 - 64620 (hydraulic kit)
 - 28800 (light kit)
 - 56369 or 56462 (control)
 - 27780 (harness kit, from Step 4)
 - 67960-1 (mount, from Step 5 – *must match blade*)

2001 Acme Motors

Section 1 Suburbanite™ & MIDWEIGHT™ blades

Model	Body Style	DRW	Box Option	Engine Type	Min FGAWR	Min RGAWR	Min GVWR	Harness Kit	Personal Plow system		Ballast Guidelines, lbs (1)	UltraMount® system		Ballast Guidelines, lbs (1)			
									Mount Kit	Notes		Mount Kit	Notes				
15000 RS	4x4	Reg Cab	No	6.5 Box	4.3L V6	3925	3750	6400	HB3/HB4 use	1523	3,6,8	---	100	67960-1	2,3,4,6	350	300
15000 TU	4x4	Reg Cab	No	6.5 Box	4.8L V8	3925	3750	6400		1523	3,6,8	---	150	67960-1	2,3,4,6	400	400
15000 VX	4x4	Reg Cab	No	6.5 Box	5.3L V8	3925	3750	6400		1523	3,6,8	---	100	67960-1	2,3,4,6	350	350

Suburbanite™		
6'-8" POLY	7'-4" POLY	
SUB68	SUB74	
Blade Assembly	27546	27548
AQ&L Assembly Box 1	27550	
AQ&L Assembly Box 2	n/a	
Hydraulic Kit	27516	
Light Kit	64100	
Choose a Joystick Control or Hand-Held Control	56369	
	56462	

UltraMount™		
MIDWEIGHT™		
7'-6" STEEL	7'-6" POLY	
IUTH75	IUTHY75	
Blade Assembly	64340	64330
AQ&L Assembly Box 1	64336	
AQ&L Assembly Box 2	67992	
Hydraulic Kit	64620	
Light Kit	28800	
Choose a Joystick Control or Hand-Held Control	56369	
	56462	

- Notes:**
- Ballast amounts are based on a "Representative Vehicle," defined in the vehicle selection guide instructions, and must be modified for all other configurations for axle and GVWR compliance.
 - Recommended snowplow prep package whenever available.
 - Requires bumper notching.

- Recommended Z85 suspension.
- All New Style Only (2nd # in model # is 5 not 0) example: K15903. Refer to label in glove box for model number.
- These Snowplows Are For Personal/Homeowner Use Only.

2001 Chevy/GMC

Section 1 Suburbanite™ & MIDWEIGHT™ Blades

 Suburbanite™	
6'-8" POLY SUB68	7'-4" POLY SUB74
Plow Blade Assembly AQ&L Assembly Box 1 AQ&L Assembly Box 2 Hydraulic Kit Light Kit Choose a Joystick Control or Hand-Held Control	
27546 27548	
27550	
n/a	
27516	
64100	
56369	
56462	

 UltraMount™	
MIDWEIGHT™	
7'-6" STEEL IUTH75	7'-6" POLY IUTHY75
64340 64330	
64336	
67992	
64620	
28800	
56369	
56462	

Model	Body Style	DRW	Box Option	Engine Type	Min F G A W R	Min R G A W R	Min G V W R	Harness Kit	Personal Plow system		Ballast Guidelines, lbs (1)		UltraMount® system		Ballast Guidelines, lbs (1)			
									Mount Kit	Notes			Mount Kit	Notes				
BLAZER/JIMMY	4x4	SU-4DR	No	---	4.3L V6	2800	2900	5350	HB3/HB4 use 27480	1503	8,16	200	300	n/a	---	---	---	
TAHOE/YUKON 1500	4x4	SU-4DR	No	---	4.8L V6	3600	4000	6900	HB3/HB4 use 8437-1	1523	3,6,8	---	0	67960-1	2,3,4,6	300	300	
TAHOE/YUKON 1500	4x4	SU-4DR	No	---	4.8L V8	3600	3750	6800		1523	3,6,8	---	0	67960-1	2,3,4,6	---	300	300
TAHOE/YUKON 1500	4x4	SU-4DR	No	---	5.3L V6	3600	4000	6900		1523	3,6,8	---	0	67960-1	2,3,4,6	---	300	300
TAHOE/YUKON 1500	4x4	SU-4DR	No	---	5.3L V6	3600	3750	6800		1523	3,6,8	---	0	67960-1	2,3,4,6	---	300	300
YUKON DENALI 1500	4x4	SU-4DR	No	---	6.0L V8	3600	4000	7200		1523	3,6,8	---	0	67960-1	2,3,4,6	---	---	---
SUBURBAN/YUKON XL 1500	4x4	SU-4DR	No	---	5.3L V8	3600	4000	7200		1523	3,6,8	---	0	67960-1	2,3,4,6	---	---	---
SUBURBAN/YUKON XL 2500	4x4	SU-4DR	No	---	6.0L V8	4180	6000	8600		n/a	---	---	---	---	67981-2	---	0	0
S-10/SONOMA	4x4	Ext Cab	No	6.0 Box	4.3L V6	2800	2700	5100		HB3/HB4 use 27480	1503	8,16	300	400	n/a	---	---	---
S-10/SONOMA	4x4	Crew Cab	No	4.5 Box	4.3L V6	2800	2700	5150		1503	8,16	400	500	n/a	---	---	---	
S-10/SONOMA+3 DR	4x4	Ext Cab	No	6.0 Box	4.3L V6	2800	2700	5100		1503	8,16	300	400	n/a	---	---	---	
K1500 SILV/SIERRA	4x4	Reg Cab	No	6.5 Box	4.3L V6	3925	3750	6100		1523	3,6,8	---	100	67960-1	2,3,4,6	350	300	
K1500 SILV/SIERRA	4x4	Reg Cab	No	6.5 Box	4.3L V6	3600	3750	6100		1523	3,6,8	---	100	67960-1	2,3,4,6	350	300	
K1500 SILV/SIERRA	4x4	Reg Cab	No	6.5 Box	4.8L V8	3925	3750	6100		1523	3,6,8	---	100	67960-1	2,3,4,6	350	350	
K1500 SILV/SIERRA	4x4	Reg Cab	No	6.5 Box	4.8L V8	3600	3750	6100		1523	3,6,8	---	100	67960-1	2,3,4,6	350	350	
K1500 SILV/SIERRA	4x4	Reg Cab	No	6.5 Box	5.3L V8	3925	3750	6100		1523	3,6,8	---	100	67960-1	2,3,4,6	350	350	
K1500 SILV/SIERRA	4x4	Reg Cab	No	6.5 Box	5.3L V8	3600	3750	6100		1523	3,6,8	---	100	67960-1	2,3,4,6	350	350	
K1500 SILV/SIERRA	4x4	Reg Cab	No	8.0 Box	4.3L V6	3925	3750	6400	1523	3,6,8	---	100	67960-1	2,3,4,6	350	350		
K1500 SILV/SIERRA	4x4	Reg Cab	No	8.0 Box	4.3L V6	3600	3750	6400	1523	3,6,8	---	100	67960-1	2,3,4,6	350	350		
K1500 SILV/SIERRA	4x4	Reg Cab	No	8.0 Box	4.8L V8	3925	3750	6400	1523	3,6,8	---	150	67960-1	2,3,4,6	400	350		
K1500 SILV/SIERRA	4x4	Reg Cab	No	8.0 Box	4.8L V8	3600	3750	6400	1523	3,6,8	---	150	67960-1	2,3,4,6	400	400		
K1500 SILV/SIERRA	4x4	Reg Cab	No	8.0 Box	5.3L V8	3925	3750	6400	1523	3,6,8	---	150	67960-1	2,3,4,6	350	350		
K1500 SILV/SIERRA	4x4	Reg Cab	No	8.0 Box	5.3L V8	3600	3750	6400	HB3/HB4 use 8437-1	1523	3,6,8	---	150	67960-1	2,3,4,6	400	400	
K1500 SILV/SIERRA	4x4	Ext Cab	No	6.5 Box	4.3L V6	3925	3750	6400	1523	3,6,8	---	100	67960-1	2,3,4,6	350	350		
K1500 SILV/SIERRA	4x4	Ext Cab	No	6.5 Box	4.3L V6	3600	3750	6400	1523	3,6,8	---	100	67960-1	2,3,4,6	---	---		
K1500 SILV/SIERRA	4x4	Ext Cab	No	6.5 Box	4.8L V8	3925	3750	6400	1523	3,6,8	---	150	67960-1	2,3,4,6	400	350		
K1500 SILV/SIERRA	4x4	Ext Cab	No	6.5 Box	4.8L V8	3600	3750	6400	1523	3,6,8	---	150	67960-1	2,3,4,6	---	---		
K1500 SILV/SIERRA	4x4	Ext Cab	No	6.5 Box	5.3L V8	3925	3750	6400	1523	3,6,8	---	150	67960-1	2,3,4,6	400	350		
K1500 SILV/SIERRA	4x4	Ext Cab	No	6.5 Box	5.3L V8	3600	3750	6400	1523	3,6,8	---	150	67960-1	2,3,4,6	---	---		
K1500 SILV/SIERRA	4x4	Ext Cab	No	8.0 Box	4.3L V6	3925	3750	6400	1523	3,6,8	---	200	67960-1	2,3,4,6	450	400		
K1500 SILV/SIERRA	4x4	Ext Cab	No	8.0 Box	4.3L V6	3600	3750	6400	1523	3,6,8	---	200	67960-1	2,3,4,6	---	---		
K1500 SILV/SIERRA	4x4	Ext Cab	No	8.0 Box	4.8L V8	3925	3750	6400	1523	3,6,8	---	200	67960-1	2,3,4,6	450	400		
K1500 SILV/SIERRA	4x4	Ext Cab	No	8.0 Box	4.8L V8	3600	3750	6400	1523	3,6,8	---	200	67960-1	2,3,4,6	---	---		
K1500 SILV/SIERRA	4x4	Ext Cab	No	8.0 Box	5.3L V8	3925	3750	6400	1523	3,6,8	---	200	67960-1	2,3,4,6	450	400		
K1500 SILV/SIERRA	4x4	Ext Cab	No	8.0 Box	5.3L V8	3600	3750	6400	1523	3,6,8	---	200	67960-1	2,3,4,6	---	---		

- Notes:**
- Ballast amounts are based on a "Representative Vehicle," defined in the vehicle selection guide instructions, and must be modified for all other configurations for axle and GVWR compliance.
 - Recommended snowplow prep package whenever available.
 - Requires bumper notching.

- Recommended Z85 suspension.
- All New Style Only (2nd # in model # is 5 not 0) example: K15903. Refer to label in glove box for model number.
- These Snowplows Are For Personal/Homeowner Use Only.
- Not intended for use with High Rider or ZR2 style trucks.

2001 Chevy/GMC

Section 1 Suburbanite™ & MIDWEIGHT™ Blades

 Suburbanite™	
6'-8" POLY SUB68	7'-4" POLY SUB74
Plow Blade Assembly AQ&L Assembly Box 1 AQ&L Assembly Box 2 Hydraulic Kit Light Kit Choose a Joystick Control or Hand-Held Control	
27546	27548
27550	
n/a	
27516	
64100	
56369	
56462	

 UltraMount™	
MIDWEIGHT™	
7'-6" STEEL IUTH75	7'-6" POLY IUTHY75
64340	64330
64336	
67992	
64620	
28800	
56369	
56462	

Model	Body Style	DRW	Box Option	Engine Type	Min F G A W R	Min R G A W R	Min G V W R	Harness Kit	Personal Plow system		Ballast Guidelines, lbs (1)	UltraMount® system		Ballast Guidelines, lbs (1)		
									Mount Kit	Notes		Mount Kit	Notes			
GMC C3	4x4	Ext Cab	No	6.5 Box	6.0L V8	3925	4000	7200	1523	3,6,8	---	150	67960-1	2,3,4,6	400	400
K1500HD SILV/SIERRA	4x4	Crew Cab	No	6.5 Box	6.0L V8	4500	6000	8600	n/a	---	---	---	67981-2	---	300	300
K1500HD SILV/SIERRA	4x4	Crew Cab	No	6.5 Box	6.0L V8	4410	6000	8600	n/a	---	---	---	67981-2	---	300	300
K2500 SILV/SIERRA	4x4	Ext Cab	No	6.5 Box	6.0L V8	4500	6000	8600	n/a	---	---	---	67981-2	---	400	400
K2500 SILV/SIERRA	4x4	Ext Cab	No	6.5 Box	6.0L V8	4410	6000	8600	n/a	---	---	---	67981-2	---	400	400
K2500HD SILV/SIERRA	4x4	Reg Cab	No	8.0 Box	6.0L V8	4800	6084	9200	n/a	---	---	---	67981-2	---	250	250
K2500HD SILV/SIERRA	4x4	Reg Cab	No	8.0 Box	6.0L V8	4500	6084	9200	n/a	---	---	---	67981-2	---	250	250
K2500HD SILV/SIERRA	4x4	Reg Cab	No	8.0 Box	6.6L D	4800	6084	9200	n/a	---	---	---	67981-2	---	400	400
K2500HD SILV/SIERRA	4x4	Reg Cab	No	8.0 Box	6.6L D	4500	6084	9200	n/a	---	---	---	67981-2	---	500	450
K2500HD SILV/SIERRA	4x4	Reg Cab	No	8.0 Box	8.1L V8	4800	6084	9200	n/a	---	---	---	67981-2	---	350	350
K2500HD SILV/SIERRA	4x4	Reg Cab	No	8.0 Box	8.1L V8	4500	6084	9200	n/a	---	---	---	67981-2	---	350	350
K2500HD SILV/SIERRA	4x4	Ext Cab	No	6.5 Box	6.0L V8	4800	6084	9200	n/a	---	---	---	67981-2	---	250	250
K2500HD SILV/SIERRA	4x4	Ext Cab	No	6.5 Box	6.0L V8	4670	6084	9200	n/a	---	---	---	67981-2	---	250	250
K2500HD SILV/SIERRA	4x4	Ext Cab	No	6.5 Box	6.6L D	4800	6084	9200	n/a	---	---	---	67981-2	---	400	400
K2500HD SILV/SIERRA	4x4	Ext Cab	No	6.5 Box	6.6L D	4670	6084	9200	n/a	---	---	---	67981-2	---	400	400
K2500HD SILV/SIERRA	4x4	Ext Cab	No	6.5 Box	8.1L V8	4800	6084	9200	n/a	---	---	---	67981-2	---	350	350
K2500HD SILV/SIERRA	4x4	Ext Cab	No	6.5 Box	8.1L V8	4670	6084	9200	n/a	---	---	---	67981-2	---	350	350
K2500HD SILV/SIERRA	4x4	Ext Cab	No	8.0 Box	6.0L V8	4800	6084	9200	n/a	---	---	---	67981-2	---	250	250
K2500HD SILV/SIERRA	4x4	Ext Cab	No	8.0 Box	6.6L D	4670	6084	9200	n/a	---	---	---	67981-2	---	700	650
K2500HD SILV/SIERRA	4x4	Ext Cab	No	8.0 Box	8.1L V8	4800	6084	9200	n/a	---	---	---	67981-2	---	350	350
K2500HD SILV/SIERRA	4x4	Ext Cab	No	8.0 Box	8.1L V8	4670	6084	9200	n/a	---	---	---	67981-2	---	350	350
K2500HD SILV/SIERRA	4x4	Crew Cab	No	6.5 Box	6.0L V8	4800	6084	9200	n/a	---	---	---	67981-2	---	200	200
K2500HD SILV/SIERRA	4x4	Crew Cab	No	6.5 Box	6.0L V8	4500	6084	9200	n/a	---	---	---	67981-2	---	200	200
K2500HD SILV/SIERRA	4x4	Crew Cab	No	6.5 Box	6.6L D	4800	6084	9200	n/a	---	---	---	67981-2	---	400	400
K2500HD SILV/SIERRA	4x4	Crew Cab	No	6.5 Box	8.1L V8	4800	6084	9200	n/a	---	---	---	67981-2	---	350	350
K2500HD SILV/SIERRA	4x4	Crew Cab	No	8.0 Box	6.0L V8	4800	6084	9200	n/a	---	---	---	67981-2	---	250	250
K2500HD SILV/SIERRA	4x4	Crew Cab	No	8.0 Box	6.6L D	4800	6084	9200	n/a	---	---	---	67981-2	---	950	900
K2500HD SILV/SIERRA	4x4	Crew Cab	No	8.0 Box	8.1L V8	4800	6084	9200	n/a	---	---	---	67981-2	---	550	500
K2500HD SILV/SIERRA	4x4	All	No	Chassis	All	All	All	8501	n/a	---	---	---	67981-2	---	?	?

- Notes:**
- Ballast amounts are based on a "Representative Vehicle," defined in the vehicle selection guide instructions, and must be modified for all other configurations for axle and GVWR compliance.
 - Recommended snowplow prep package whenever available.
 - Requires bumper notching.

- Recommended Z85 suspension.
- All New Style Only (2nd # in model # is 5 not 0) example: K15903. Refer to label in glove box for model number.
- These Snowplows Are For Personal/Homeowner Use Only.

2001 Chevy/GMC

Section 2 PRO-PLOW®, PRO PLUS® & Heavy Weight Blades

PRO-PLOW®					PRO PLUS®				
7'-6" STEEL	7'-6" POLY	8'-0" STEEL	8'-0" POLY	8'-6" STEEL	7'-6" STEEL	8'-0" STEEL	8'-6" STEEL	9'-0" STEEL	
IUTP75	IUTP75	IUTP80	IUTP80	IUTP85	IUTPP75	IUTPP80	IUTPP85	IUTPP90	
Blade Assembly	60381	62400	60390	62450	60308	64750	66980	66974	66901
AQ&L Assembly Box 1	67950			66490					
AQ&L Assembly Box 2	67951-2				64999				
Hydraulic Kit	64588			64999					
Light Kit	28800								
Choose a Joystick Control or Hand-Held Control	56369								
	56462								

Heavy Weight	
9'-0" STEEL	10'-0" STEEL
IUHW90	IUHW10
62301	62302
62298-1	
62299-1	
64400	
28800	
56369	
56462	

Model	Body Style	DRW	Box Option	Engine Type	Min FAWR	Min RAWR	Min GVWR	Harness Kit	UltraMount® system		Ballast Guidelines, lbs (1)								UniMount® system		Ballast Guidelines, lbs (1)			
									Mount Kit	Notes	1	2	3	4	5	6	7	8	9	10	Mount Kit	Notes	1	2
K1500 SILV/SIERRA	4x4	Reg Cab	No	6.5 Box	4.3L V6	3925	3750	6100	67960-1	2,3,4,6	450	500	500	500	500	---	---	---	---	n/a	---	---	---	---
K1500 SILV/SIERRA	4x4	Reg Cab	No	6.5 Box	4.3L V6	3600	3750	6100	67960-1	2,3,4,6	450	700	550	750	650	---	---	---	---	n/a	---	---	---	---
K1500 SILV/SIERRA	4x4	Reg Cab	No	6.5 Box	4.8L V8	3925	3750	6100	67960-1	2,3,4,6	500	550	500	550	550	---	---	---	---	n/a	---	---	---	---
K1500 SILV/SIERRA	4x4	Reg Cab	No	6.5 Box	5.3L V8	3925	3750	6100	67960-1	2,3,4,6	500	550	500	550	550	---	---	---	---	n/a	---	---	---	---
K1500 SILV/SIERRA	4x4	Reg Cab	No	8.0 Box	4.3L V6	3925	3750	6400	67960-1	2,3,4,6	450	500	450	500	500	---	---	---	---	n/a	---	---	---	---
K1500 SILV/SIERRA	4x4	Reg Cab	No	8.0 Box	4.3L V6	3600	3750	6400	67960-1	2,3,4,6	650	850	750	900	850	---	---	---	---	n/a	---	---	---	---
K1500 SILV/SIERRA	4x4	Reg Cab	No	8.0 Box	4.8L V8	3925	3750	6400	67960-1	2,3,4,6	500	550	500	550	500	---	---	---	---	n/a	---	---	---	---
K1500 SILV/SIERRA	4x4	Reg Cab	No	8.0 Box	5.3L V8	3925	3750	6400	67960-1	2,3,4,6	500	550	500	550	500	---	---	---	---	n/a	---	---	---	---
K1500 SILV/SIERRA	4x4	Ext Cab	No	6.5 Box	4.3L V6	3925	3750	6400	67960-1	2,3,4,6	500	600	500	---	550	---	---	---	---	n/a	---	---	---	---
K1500 SILV/SIERRA	4x4	Ext Cab	No	6.5 Box	4.8L V8	3925	3750	6400	67960-1	2,3,4,6	550	---	---	---	---	---	---	---	---	n/a	---	---	---	---
K1500 SILV/SIERRA	4x4	Ext Cab	No	6.5 Box	5.3L V8	3925	3750	6400	67960-1	2,3,4,6	550	---	---	---	---	---	---	---	---	n/a	---	---	---	---
GMC C3	4x4	Ext Cab	No	6.5 Box	6.0L V8	3925	4000	7200	67960-1	2,3,4,6	550	800	650	800	750	---	---	---	---	n/a	---	---	---	---
K1500HD SILV/SIERRA	4x4	Crew Cab	No	6.5 Box	6.0L V8	4500	6000	8600	67981-2	---	450	600	450	650	550	---	---	---	---	n/a	---	---	---	---
K1500HD SILV/SIERRA	4x4	Crew Cab	No	6.5 Box	7.0L V8	4410	6000	8600	67981-2	---	750	---	900	---	1000	---	---	---	---	n/a	---	---	---	---
K2500 SILV/SIERRA	4x4	Ext Cab	No	6.5 Box	6.0L V8	4500	6000	8600	67981-2	---	500	550	550	550	650	700	800	900	n/a	---	---	---	---	
K2500 SILV/SIERRA	4x4	Ext Cab	No	6.5 Box	6.0L V8	4410	6000	8600	67981-2	---	500	550	550	550	950	---	---	---	---	n/a	---	---	---	---
K2500HD SILV/SIERRA	4x4	Reg Cab	No	8.0 Box	6.0L V8	4800	6084	9200	67981-2	---	400	400	400	450	400	500	500	550	550	n/a	---	---	---	---
K2500HD SILV/SIERRA	4x4	Reg Cab	No	8.0 Box	6.0L V8	4500	6084	9200	67981-2	---	400	400	400	450	400	500	500	550	550	n/a	---	---	---	---
K2500HD SILV/SIERRA	4x4	Reg Cab	No	8.0 Box	6.0L V8	4800	6084	9200	67981-2	---	400	400	400	450	400	500	500	550	550	n/a	---	---	---	---
K2500HD SILV/SIERRA	4x4	Reg Cab	No	8.0 Box	6.0L V8	4500	6084	9200	67981-2	---	400	400	400	450	400	500	500	550	550	n/a	---	---	---	---
K2500HD SILV/SIERRA	4x4	Reg Cab	No	8.0 Box	6.6L D	4800	6084	9200	67981-2	---	550	600	550	600	550	750	850	950	1000	n/a	---	---	---	---
K2500HD SILV/SIERRA	4x4	Reg Cab	No	8.0 Box	8.1L V8	4800	6084	9200	67981-2	---	450	500	500	500	500	600	600	650	650	n/a	---	---	---	---
K2500HD SILV/SIERRA	4x4	Reg Cab	No	8.0 Box	8.1L V8	4500	6084	9200	67981-2	---	800	1000	900	---	950	---	---	---	---	n/a	---	---	---	---
K2500HD SILV/SIERRA	4x4	Ext Cab	No	6.5 Box	6.0L V8	4800	6084	9200	67981-2	---	350	400	400	400	400	500	500	550	550	n/a	---	---	---	---
K2500HD SILV/SIERRA	4x4	Ext Cab	No	6.5 Box	6.0L V8	4670	6084	9200	67981-2	---	350	400	400	400	400	500	500	550	550	n/a	---	---	---	---
K2500HD SILV/SIERRA	4x4	Ext Cab	No	6.5 Box	6.6L D	4800	6084	9200	67981-2	---	500	700	550	750	650	---	---	---	---	n/a	---	---	---	---
K2500HD SILV/SIERRA	4x4	Ext Cab	No	6.5 Box	6.6L D	4670	6084	9200	67981-2	---	1000	---	---	---	---	---	---	---	---	n/a	---	---	---	---
K2500HD SILV/SIERRA	4x4	Ext Cab	No	6.5 Box	8.1L V8	4800	6084	9200	67981-2	---	500	500	500	500	500	850	950	---	---	n/a	---	---	---	---
K2500HD SILV/SIERRA	4x4	Ext Cab	No	6.5 Box	8.1L V8	4670	6084	9200	67981-2	---	650	950	800	950	900	---	---	---	---	n/a	---	---	---	---
K2500HD SILV/SIERRA	4x4	Ext Cab	No	8.0 Box	6.0L V8	4800	6084	9200	67981-2	---	400	400	400	400	400	500	500	550	550	n/a	---	---	---	---
K2500HD SILV/SIERRA	4x4	Ext Cab	No	8.0 Box	6.0L V8	4670	6084	9200	67981-2	---	400	400	400	400	400	500	500	550	550	n/a	---	---	---	---
K2500HD SILV/SIERRA	4x4	Ext Cab	No	8.0 Box	6.0L V8	4800	6084	9200	67981-2	---	400	400	400	400	400	500	500	550	550	n/a	---	---	---	---
K2500HD SILV/SIERRA	4x4	Ext Cab	No	8.0 Box	6.6L D	4800	6084	9200	67981-2	---	950	---	---	---	---	---	---	---	---	n/a	---	---	---	---
K2500HD SILV/SIERRA	4x4	Ext Cab	No	8.0 Box	8.1L V8	4800	6084	9200	67981-2	---	600	800	700	850	800	---	---	---	---	n/a	---	---	---	---
K2500HD SILV/SIERRA	4x4	Crew Cab	No	6.5 Box	6.0L V8	4800	6084	9200	67981-2	---	350	350	350	400	350	450	450	500	500	n/a	---	---	---	---
K2500HD SILV/SIERRA	4x4	Crew Cab	No	6.5 Box	6.0L V8	4500	6084	9200	67981-2	---	600	650	500	700	600	---	---	---	---	n/a	---	---	---	---
K2500HD SILV/SIERRA	4x4	Crew Cab	No	6.5 Box	8.1L V8	4800	6084	9200	67981-2	---	800	---	950	---	---	---	---	---	---	n/a	---	---	---	---
K2500HD SILV/SIERRA	4x4	Crew Cab	No	8.0 Box	6.0L V8	4800	6084	9200	67981-2	---	350	400	400	400	400	500	500	600	700	n/a	---	---	---	---
K2500HD SILV/SIERRA	4x4	All	No	Chassis	All	All	All	8501	67981-2	---	?	?	?	?	?	?	?	?	?	n/a	---	---	---	---

Notes:
 1. Ballast amounts are based on a "Representative Vehicle," defined in the vehicle selection guide instructions, and must be modified for all other configurations for axle and GVWR compliance.
 2. Recommended snowplow prep package whenever available.

3. Requires bumper notching.
 4. Recommended Z85 suspension.
 6. All New Style Only (2nd # in model # is 5 not 0) example: K15903. Refer to label in glove box for model number.

2001 Chevy/GMC

Section 2 PRO-PLOW®, PRO PLUS® & Heavy Weight Blades

UltraMount								
PRO-PLOW®					PRO PLUS®			
7'-6" STEEL	7'-6" POLY	8'-0" STEEL	8'-0" POLY	8'-6" STEEL	7'-6" STEEL	8'-0" STEEL	8'-6" STEEL	9'-0" STEEL
IUTP75	IUTP75	IUTP80	IUTPY80	IUTP85	IUTPP75	IUTPP80	IUTPP85	IUTPP90
60381	62400	60390	62450	60308	64750	66980	66974	66901
67950					66490			
64588					64999			
28800					56369			
56369					56462			

UniMount	
Heavy Weight	
9'-0" STEEL	10'-0" STEEL
IUHW90	IUHW10
62301	62302
62298-1	
62299-1	
64400	
28800	
56369	
56462	

Model	Body Style	DRW	Box Option	Engine Type	Min FAWR	Min RGAWR	Min GVWR	Harness Kit	UltraMount® system		Ballast Guidelines, lbs (1)								UniMount® system		Ballast Guidelines, lbs (1)		
									Mount Kit	Notes	Mount Kit	Notes	Mount Kit	Notes	Mount Kit	Notes	Mount Kit	Notes					
K3500 SILV/SIERRA	4x4	Reg Cab	Yes	8.0 Box	6.0L V8	4800	8550	11400	67981-2	---	---	---	---	---	200	---	---	300	300	n/a	---	---	---
K3500 SILV/SIERRA	4x4	Reg Cab	Yes	8.0 Box	6.0L V8	4670	8550	11400	67981-2	---	---	---	---	---	150	---	---	300	300	n/a	---	---	---
K3500 SILV/SIERRA	4x4	Reg Cab	Yes	8.0 Box	6.6L D	4800	8550	11400	67981-2	---	---	---	---	---	400	---	---	---	---	n/a	---	---	---
K3500 SILV/SIERRA	4x4	Reg Cab	Yes	8.0 Box	6.6L D	4670	8550	11400	67981-2	---	---	---	---	---	700	---	---	---	---	n/a	---	---	---
K3500 SILV/SIERRA	4x4	Reg Cab	Yes	8.0 Box	8.1L V8	4800	8550	11400	67981-2	---	---	---	---	---	350	---	---	750	800	n/a	---	---	---
K3500 SILV/SIERRA	4x4	Reg Cab	Yes	8.0 Box	8.1L V8	4670	8550	11400	67981-2	---	---	---	---	---	400	---	---	1000	---	n/a	---	---	---
K3500 SILV/SIERRA	4x4	Ext Cab	Yes	8.0 Box	6.0L V8	4800	8550	11400	67981-2	---	---	---	---	---	150	---	---	250	250	n/a	---	---	---
K3500 SILV/SIERRA	4x4	Ext Cab	Yes	8.0 Box	6.0L V8	4670	8550	11400	67981-2	---	---	---	---	---	150	---	---	500	600	n/a	---	---	---
K3500 SILV/SIERRA	4x4	Ext Cab	Yes	8.0 Box	6.0L V8	4500	8550	11400	67981-2	---	---	---	---	---	300	---	---	1000	---	n/a	---	---	---
K3500 SILV/SIERRA	4x4	Ext Cab	Yes	8.0 Box	8.1L V8	4800	8550	11400	67981-2	---	---	---	---	---	850	---	---	---	---	n/a	---	---	---
K3500 SILV/SIERRA	4x4	Crew Cab	Yes	8.0 Box	6.0L V8	4800	8550	11400	67981-2	---	---	---	---	---	0	---	---	100	100	n/a	---	---	---
K3500 SILV/SIERRA	4x4	Crew Cab	Yes	8.0 Box	6.0L V8	4670	8550	11400	67981-2	---	---	---	---	---	0	---	---	600	700	n/a	---	---	---
K3500 SILV/SIERRA	4x4	Crew Cab	Yes	8.0 Box	6.0L V8	4500	8550	11400	67981-2	---	---	---	---	---	450	---	---	---	---	n/a	---	---	---
K3500 SILV/SIERRA	4x4	All	Yes	Chassis	All	All	All	8501	67981-2	---	---	---	---	---	?	---	---	?	?	n/a	---	---	---
K3600 SILV/SIERRA	4x4	All	Yes	Chassis	All	All	All	8501	67981-2	---	---	---	---	---	?	---	---	?	?	n/a	---	---	---
C3500 SILV/SIERRA	4x2	Ext Cab	Yes	8.0 Box	6.0L V8	4800	8550	11400	67981-2	---	---	---	---	---	50	---	---	150	200	n/a	---	---	---
C3500 SILV/SIERRA	4x2	Ext Cab	Yes	8.0 Box	6.0L V8	4670	8550	11400	67981-2	---	---	---	---	---	50	---	---	150	200	n/a	---	---	---
C3500 SILV/SIERRA	4x2	Ext Cab	Yes	8.0 Box	6.0L V8	4500	8550	11400	67981-2	---	---	---	---	---	50	---	---	150	150	n/a	---	---	---
C3500 SILV/SIERRA	4x2	Ext Cab	Yes	8.0 Box	6.6L D	4800	8550	11400	67981-2	---	---	---	---	---	250	---	---	900	1000	n/a	---	---	---
C3500 SILV/SIERRA	4x2	Ext Cab	Yes	8.0 Box	6.6L D	4670	8550	11400	67981-2	---	---	---	---	---	750	---	---	---	---	n/a	---	---	---
C3500 SILV/SIERRA	4x2	Ext Cab	Yes	8.0 Box	8.1L V8	4800	8550	11400	67981-2	---	---	---	---	---	200	---	---	550	650	n/a	---	---	---
C3500 SILV/SIERRA	4x2	Ext Cab	Yes	8.0 Box	8.1L V8	4670	8550	11400	67981-2	---	---	---	---	---	400	---	---	---	---	n/a	---	---	---
C3500 SILV/SIERRA	4x2	Ext Cab	Yes	8.0 Box	8.1L V8	4500	8550	11400	67981-2	---	---	---	---	---	900	---	---	---	---	n/a	---	---	---
C3500 SILV/SIERRA	4x2	Crew Cab	Yes	8.0 Box	6.0L V8	4800	8550	11400	67981-2	---	---	---	---	---	0	---	---	100	150	n/a	---	---	---
C3500 SILV/SIERRA	4x2	Crew Cab	Yes	8.0 Box	6.0L V8	4670	8550	11400	67981-2	---	---	---	---	---	0	---	---	100	150	n/a	---	---	---
C3500 SILV/SIERRA	4x2	Crew Cab	Yes	8.0 Box	6.0L V8	4500	8550	11400	67981-2	---	---	---	---	---	0	---	---	500	650	n/a	---	---	---
C3500 SILV/SIERRA	4x2	Crew Cab	Yes	8.0 Box	6.6L D	4800	8550	11400	67981-2	---	---	---	---	---	600	---	---	---	---	n/a	---	---	---
C3500 SILV/SIERRA	4x2	Crew Cab	Yes	8.0 Box	8.1L V8	4800	8550	11400	67981-2	---	---	---	---	---	200	---	---	950	---	n/a	---	---	---
C3500 SILV/SIERRA	4x2	Crew Cab	Yes	8.0 Box	8.1L V8	4670	8550	11400	67981-2	---	---	---	---	---	800	---	---	---	---	n/a	---	---	---
C3500 SILV/SIERRA	4x2	All	Yes	Chassis	All	All	All	10001	67981-2	---	---	---	---	---	?	---	---	?	?	n/a	---	---	---
C3600 SILV/SIERRA	4x2	All	Yes	Chassis	All	All	All	10001	67981-2	---	---	---	---	---	?	---	---	?	?	n/a	---	---	---
4500/5500 (Low Pro)	4x2	All	Yes	Chassis	All	All	All	10001	n/a	---	---	---	---	---	---	---	---	---	---	62275	---	?	?
4500/5500 T-40	4x2	All	Yes	Chassis	All	All	All	10001	n/a	---	---	---	---	---	---	---	---	---	---	62275	---	?	?
4500/5500 T-50	4x2	All	Yes	Chassis	All	All	All	10001	n/a	---	---	---	---	---	---	---	---	---	---	62275	---	?	?

Notes:
1. Ballast amounts are based on a "Representative Vehicle," defined in the vehicle selection guide instructions, and must be modified for all other configurations for axle and GVWR compliance.

2001 Chevy/GMC

Section 3

MVP® & MVP PLUS™ Blades

MVP®	MVP PLUS™					
8'-6" STEEL	7'-6" STEEL	7'-6" POLY	8'-6" STEEL	8'-6" POLY	9'-6" STEEL	9'-6" POLY
IUMVPP85	IUTHVPP75	IUTHVPPY75	IUTHVPP85	IUTHVPPY85	IUTHVPP95	IUTHVPPY95
Blade Assembly	63819	44475	44575	44485	44585	44495
AQ&L Assembly Box 1	63910					
AQ&L Assembly Box 2	67951-2	44225				
Hydraulic Kit	64777					
Light Kit	28800					
Choose a Joystick Control or Hand-Held Control	96369	96700				
	96462	96600				

Model	Body Style	DRW	Box Option	Engine Type	Min F G A W R	Min R G A W R	Min G V W R	Harness Kit	UltraMount® system		67960-1	2,3,4,6	550	550	---	---	---	---		
									Mount Kit	Notes										
K1500 SILV/SIERRA	4x4	Reg Cab	No	6.5 Box	4.3L V6	3925	3750	6100			67960-1	2,3,4,6	---	550	550	---	---	---	---	
K1500 SILV/SIERRA	4x4	Reg Cab	No	8.0 Box	4.3L V6	3925	3750	6400			67960-1	2,3,4,6	---	550	550	---	---	---	---	
K1500 SILV/SIERRA	4x4	Reg Cab	No	8.0 Box	4.8L V8	3925	3750	6400			67960-1	2,3,4,6	---	600	550	---	---	---	---	
K1500 SILV/SIERRA	4x4	Reg Cab	No	8.0 Box	5.3L V8	3925	3750	6400			67960-1	2,3,4,6	---	600	550	---	---	---	---	
K1500HD SILV/SIERRA	4x4	Crew Cab	No	6.5 Box	6.0L V8	4500	6000	8600			67981-2	---	---	---	1000	---	---	---	---	
K2500 SILV/SIERRA	4x4	Ext Cab	No	6.5 Box	6.0L V8	4500	6000	8600			67981-2	---	---	650	600	950	750	---	---	
K2500 SILV/SIERRA	4x4	Ext Cab	No	6.5 Box	6.0L V8	4410	6000	8600			67981-2	---	---	1000	850	---	---	---	---	
K2500HD SILV/SIERRA	4x4	Reg Cab	No	8.0 Box	6.0L V8	4800	6084	9200			67981-2	---	600	500	450	550	500	650	600	
K2500HD SILV/SIERRA	4x4	Reg Cab	No	8.0 Box	6.0L V8	4500	6084	9200			67981-2	---	600	500	450	550	500	1000	800	
K2500HD SILV/SIERRA	4x4	Reg Cab	No	8.0 Box	6.6L D	4800	6084	9200	HB3/HB4 use 8437-1		67981-2	---	---	800	650	---	900	---	---	
K2500HD SILV/SIERRA	4x4	Reg Cab	No	8.0 Box	8.1L V8	4800	6084	9200			67981-2	---	900	600	550	650	600	---	---	
K2500HD SILV/SIERRA	4x4	Ext Cab	No	6.5 Box	6.0L V8	4800	6084	9200			67981-2	---	600	500	450	500	500	650	600	
K2500HD SILV/SIERRA	4x4	Ext Cab	No	6.5 Box	6.0L V8	4670	6084	9200			67981-2	---	600	500	450	500	500	850	600	
K2500HD SILV/SIERRA	4x4	Ext Cab	No	6.5 Box	8.1L V8	4800	6084	9200			67981-2	---	---	900	750	---	1000	---	---	
K2500HD SILV/SIERRA	4x4	Ext Cab	No	8.0 Box	6.0L V8	4800	6084	9200			67981-2	---	550	500	450	500	500	700	600	
K2500HD SILV/SIERRA	4x4	Ext Cab	No	8.0 Box	6.0L V8	4670	6084	9200			67981-2	---	---	800	500	450	500	---	---	
K2500HD SILV/SIERRA	4x4	Crew Cab	No	6.5 Box	6.0L V8	4800	6084	9200			67981-2	---	---	550	450	400	500	450	950	700
K2500HD SILV/SIERRA	4x4	Crew Cab	No	8.0 Box	6.0L V8	4800	6084	9200			67981-2	---	---	1000	450	450	750	600	---	---
K2500HD SILV/SIERRA	4x4	All	No	Chassis	All	All	All	8501			67981-2	---	---	?	?	?	?	?	?	

- Notes:**
- Ballast amounts are based on a "Representative Vehicle," defined in the vehicle selection guide instructions, and must be modified for all other configurations for axle and GVWR compliance.
 - Recommended snowplow prep package whenever available.

- Requires bumper notching.
- Recommended Z85 suspension.
- All New Style Only (2nd # in model # is 5 not 0) example: K15903. Refer to label in glove box for model number.

2001 Chevy/GMC

Section 3 MVP® & MVP PLUS™ Blades

MVP®	MVP PLUS™					
8'-6" STEEL	7'-6" STEEL	7'-6" POLY	8'-6" STEEL	8'-6" POLY	9'-6" STEEL	9'-6" POLY
IUMV85	IUTHVPP75	IUTHVPPY75	IUTHVPP85	IUTHVPPY85	IUTHVPP95	IUTHVPPY95
Blade Assembly	63819	44475	44575	44485	44585	44495
AQ&L Assembly Box 1	63910					
AQ&L Assembly Box 2	67951-2	44225				
Hydraulic Kit	64777					
Light Kit	28800					
Choose a Joystick Control or Hand-Held Control	96369	96700				
	96462	96600				

Model	Body Style	DRW	Box Option	Engine Type	Min F G A W R	Min R G A W R	Min G V W R	Harness Kit	UltraMount® system		67981-2	350	---	---	300	250	400	350
									Mount Kit	Notes								
K3500 SILV/SIERRA	4x4	Reg Cab	Yes	8.0 Box	6.0L V8	4800	8550	11400		67981-2	---	350	---	---	300	250	400	350
K3500 SILV/SIERRA	4x4	Reg Cab	Yes	8.0 Box	6.0L V8	4670	8550	11400		67981-2	---	350	---	---	300	250	400	350
K3500 SILV/SIERRA	4x4	Reg Cab	Yes	8.0 Box	6.6L D	4800	8550	11400		67981-2	---	---	---	---	1000	---	---	---
K3500 SILV/SIERRA	4x4	Reg Cab	Yes	8.0 Box	8.1L V8	4800	8550	11400		67981-2	---	---	---	---	850	700	---	---
K3500 SILV/SIERRA	4x4	Reg Cab	Yes	8.0 Box	8.1L V8	4670	8550	11400		67981-2	---	---	---	---	---	950	---	---
K3500 SILV/SIERRA	4x4	Ext Cab	Yes	8.0 Box	6.0L V8	4800	8550	11400		67981-2	---	350	---	---	250	200	800	550
K3500 SILV/SIERRA	4x4	Ext Cab	Yes	8.0 Box	6.0L V8	4670	8550	11400		67981-2	---	850	---	---	650	450	---	---
K3500 SILV/SIERRA	4x4	Ext Cab	Yes	8.0 Box	6.0L V8	4500	8550	11400		67981-2	---	---	---	---	---	950	---	---
K3500 SILV/SIERRA	4x4	Crew Cab	Yes	8.0 Box	6.0L V8	4800	8550	11400		67981-2	---	400	---	---	150	50	950	700
K3500 SILV/SIERRA	4x4	Crew Cab	Yes	8.0 Box	6.0L V8	4670	8550	11400		67981-2	---	---	---	---	800	600	---	---
K3500 SILV/SIERRA	4x4	All	Yes	Chassis	All	All	All	8501	HB3/HB4 use	67981-2	---	?	---	---	?	?	?	?
K3600 SILV/SIERRA	4x4	All	Yes	Chassis	All	All	All	8501	8437-1	67981-2	---	?	---	---	?	?	?	?
C3500 SILV/SIERRA	4x2	Ext Cab	Yes	8.0 Box	6.0L V8	4800	8550	11400		67981-2	---	200	---	---	150	150	250	250
C3500 SILV/SIERRA	4x2	Ext Cab	Yes	8.0 Box	6.0L V8	4670	8550	11400		67981-2	---	200	---	---	150	150	250	250
C3500 SILV/SIERRA	4x2	Ext Cab	Yes	8.0 Box	6.0L V8	4500	8550	11400		67981-2	---	300	---	---	150	100	750	550
C3500 SILV/SIERRA	4x2	Ext Cab	Yes	8.0 Box	6.6L D	4800	8550	11400		67981-2	---	---	---	---	---	850	---	---
C3500 SILV/SIERRA	4x2	Ext Cab	Yes	8.0 Box	8.1L V8	4800	8550	11400		67981-2	---	900	---	---	700	500	---	---
C3500 SILV/SIERRA	4x2	Crew Cab	Yes	8.0 Box	6.0L V8	4800	8550	11400		67981-2	---	150	---	---	100	100	200	200
C3500 SILV/SIERRA	4x2	Crew Cab	Yes	8.0 Box	6.0L V8	4670	8550	11400		67981-2	---	150	---	---	100	100	650	400
C3500 SILV/SIERRA	4x2	Crew Cab	Yes	8.0 Box	6.0L V8	4500	8550	11400		67981-2	---	950	---	---	700	500	---	---
C3500 SILV/SIERRA	4x2	Crew Cab	Yes	8.0 Box	8.1L V8	4800	8550	11400		67981-2	---	---	---	---	---	950	---	---
C3500 SILV/SIERRA	4x2	All	Yes	Chassis	All	All	All	10001		67981-2	---	?	---	---	?	?	?	?
C3600 SILV/SIERRA	4x2	All	Yes	Chassis	All	All	All	10001		67981-2	---	?	---	---	?	?	?	?

Notes:
1. Ballast amounts are based on a "Representative Vehicle," defined in the vehicle selection guide instructions, and must be modified for all other configurations for axle and GVWR compliance.

2001 Dodge

Section 1 Suburbanite™ & MIDWEIGHT™ Blades

 Suburbanite™	
6'-8" POLY	7'-4" POLY
SUB68	SUB74
Plow Blade Assembly	27546 27548
AQ&L Assembly Box 1	27550
AQ&L Assembly Box 2	n/a
Hydraulic Kit	27516
Light Kit	64100
Choose a Joystick Control	56369
or Hand-Held Control	56462

 UltraMount™	
MIDWEIGHT™	
7'-6" STEEL	7'-6" POLY
IUTH75	IUTHY75
64340	64330
64336	
67992	
64620	
28800	
56369	
56462	

Model	Body Style	DRW	Box Option	Engine Type	Min F G A W R	Min R G A W R	Min G V W R	Harness Kit	Personal Plow system		Ballast Guidelines, lbs (1)	UltraMount® system		Ballast Guidelines, lbs (1)		
									Mount Kit	Notes		Mount Kit	Notes			
DURANGO	4x4	SU-4DR	No	---	4.7L V8	3600	3850	6400	n/a	---	---	---	3919	---	150	100
DURANGO	4x4	SU-4DR	No	---	5.9L V8	3600	3850	6400	n/a	---	---	---	3919	---	---	300
DAKOTA	4x4	Reg Cab	No	6.5 Box	3.9L V6	3600	3850	5920	n/a	---	---	---	3919	---	400	350
DAKOTA	4x4	Reg Cab	No	6.5 Box	3.9L V6	3600	3850	5330	n/a	---	---	---	3919	---	400	350
DAKOTA	4x4	Reg Cab	No	6.5 Box	3.9L V6	3166	3850	5920	n/a	---	---	---	3919	---	550	550
DAKOTA	4x4	Reg Cab	No	6.5 Box	3.9L V6	3166	3850	5330	n/a	---	---	---	3919	---	550	550
DAKOTA	4x4	Reg Cab	No	6.5 Box	4.7L V8	3600	3850	5990	n/a	---	---	---	3919	---	400	400
DAKOTA	4x4	Reg Cab	No	6.5 Box	4.7L V8	3600	3850	5410	n/a	---	---	---	3919	---	400	400
DAKOTA	4x4	Club Cab	No	6.5 Box	3.9L V6	3600	3850	5930	n/a	---	---	---	3919	---	400	350
DAKOTA	4x4	Club Cab	No	6.5 Box	3.9L V6	3600	3850	5540	n/a	---	---	---	3919	---	400	350
DAKOTA	4x4	Club Cab	No	6.5 Box	4.7L V8	3600	3850	6000	n/a	---	---	---	3919	---	400	400
DAKOTA	4x4	Club Cab	No	6.5 Box	4.7L V8	3600	3850	5620	n/a	---	---	---	3919	---	400	400
DAKOTA	4x4	Quad Cab	No	5.5 Box	3.9L V6	3600	3850	5890	n/a	---	---	---	3919	---	250	250
DAKOTA	4x4	Quad Cab	No	5.5 Box	4.7L V8	3600	3850	5960	n/a	---	---	---	3919	---	250	250
DAKOTA	4x4	Quad Cab	No	5.5 Box	5.9L V8	3600	3850	5960	n/a	---	---	---	3919	---	400	350
RAM 1500	4x4	Reg Cab	No	6.5 Box	5.2L V8	3850	3600	6400	n/a	---	---	---	67980	23	400	400
RAM 1500	4x4	Reg Cab	No	6.5 Box	5.9L V8	3850	3600	6400	n/a	---	---	---	67980	23	400	400
RAM 1500	4x4	Reg Cab	No	8.0 Box	5.2L V8	3850	3600	6400	n/a	---	---	---	67980	23	500	450
RAM 1500	4x4	Reg Cab	No	8.0 Box	5.9L V8	3850	3600	6400	n/a	---	---	---	67980	23	---	550
RAM 2500HD	4x4	Reg Cab	No	8.0 Box	5.9L D	5200	6500	8800	n/a	---	---	---	67980	23	500	500
RAM 2500HD	4x4	Reg Cab	No	8.0 Box	5.9L V8	5200	6200	8800	n/a	---	---	---	67980	23	300	250
RAM 2500HD	4x4	Reg Cab	No	8.0 Box	8.0L V10	5200	6500	8800	n/a	---	---	---	67980	23	350	350
RAM 2500HD	4x4	Quad Cab	No	6.5 Box	5.9L D	5200	6500	8800	n/a	---	---	---	67980	23	450	400
RAM 2500HD	4x4	Quad Cab	No	6.5 Box	5.9L V8	5200	6200	8800	n/a	---	---	---	67980	23	200	200
RAM 2500HD	4x4	Quad Cab	No	6.5 Box	8.0L V10	5200	6500	8800	n/a	---	---	---	67980	23	250	250
RAM 2500HD	4x4	Quad Cab	No	8.0 Box	5.9L D	5200	6500	8800	n/a	---	---	---	67980	23	500	450
RAM 2500HD	4x4	Quad Cab	No	8.0 Box	5.9L V8	5200	6200	8800	n/a	---	---	---	67980	23	250	250
RAM 2500HD	4x4	Quad Cab	No	8.0 Box	8.0L V10	5200	6500	8800	n/a	---	---	---	67980	23	300	300
RAM 2500HD	4x4	All	No	Chassis	All	All	All	8501	n/a	---	---	---	67980	23	?	?

- Notes:**
- Ballast amounts are based on a "Representative Vehicle," defined in the vehicle selection guide instructions, and must be modified for all other configurations for axle and GVWR compliance.
 - Requires bumper notching on Sport and LE Sport option.

2001 Dodge

Section 2

PRO-PLOW®, PRO PLUS® & Heavy Weight Blades

UltraMount																	UniMount	
PRO-PLOW®										PRO PLUS®							Heavy Weight	
7'-6" STEEL	7'-6" POLY	8'-0" STEEL	8'-0" POLY	8'-6" STEEL	7'-6" STEEL	8'-0" STEEL	8'-6" STEEL	9'-0" STEEL		9'-0" STEEL	10'-0" STEEL							
IUTP75	IUTPY75	IUTP80	IUTPY80	IUTP85	IUTPP75	IUTPP80	IUTPP85	IUTPP90		IUHW90	IUHW10							
60381	62400	60390	62450	60308	64750	66980	66974	66901		62301	62302							
67950					66490							62298-1						
67951-2					64588							62299-1						
64588					64999							64400						
28800					28800							28800						
56369					56369							56369						
56462					56462							56462						

Model	Body Style	DRW	Box Option	Engine Type	Min FAWR	Min RGAWR	Min GVWR	Harness Kit	UltraMount® system		Ballast Guidelines, lbs (1)										UniMount® system		Ballast Guidelines, lbs (1)	
									Mount Kit	Notes	Mount Kit	Notes	Mount Kit	Notes	Mount Kit	Notes	Mount Kit	Notes						
DAKOTA	4x4	Reg Cab	No	6.5 Box	3600	3850	5920	HB5 use 8436	3919	---	500	550	550	550	---	---	---	---	---	n/a	---	---	---	
DAKOTA	4x4	Reg Cab	No	6.5 Box	4.7L V8	3600	3850	5990	3919	---	500	550	550	550	---	---	---	---	---	n/a	---	---	---	
DAKOTA	4x4	Club Cab	No	6.5 Box	3.9L V6	3600	3850	5930	3919	---	500	550	550	550	---	---	---	---	---	n/a	---	---	---	
DAKOTA	4x4	Club Cab	No	6.5 Box	4.7L V8	3600	3850	6000	3919	---	500	750	600	---	---	---	---	---	---	n/a	---	---	---	
RAM 2500HD	4x4	Reg Cab	No	8.0 Box	5.9L D	5200	6500	8800	67980	23	650	700	650	700	650	750	800	800	800	n/a	---	---	---	
RAM 2500HD	4x4	Reg Cab	No	8.0 Box	5.9L V8	5200	6200	8800	67980	23	400	450	450	450	450	550	550	600	600	n/a	---	---	---	
RAM 2500HD	4x4	Reg Cab	No	8.0 Box	8.0L V10	5200	6500	8800	67980	23	500	500	500	550	500	600	650	650	650	n/a	---	---	---	
RAM 2500HD	4x4	Quad Cab	No	6.5 Box	5.9L D	5200	6500	8800	67980	23	550	600	600	600	600	700	750	900	1000	n/a	---	---	---	
RAM 2500HD	4x4	Quad Cab	No	6.5 Box	5.9L V8	5200	6200	8800	67980	23	300	350	350	350	350	450	450	500	500	n/a	---	---	---	
RAM 2500HD	4x4	Quad Cab	No	6.5 Box	8.0L V10	5200	6500	8800	67980	23	400	450	400	450	400	500	550	550	550	n/a	---	---	---	
RAM 2500HD	4x4	Quad Cab	No	8.0 Box	5.9L D	5200	6500	8800	67980	23	600	650	600	650	650	---	---	---	---	n/a	---	---	---	
RAM 2500HD	4x4	Quad Cab	No	8.0 Box	5.9L V8	5200	6200	8800	67980	23	350	400	400	400	400	500	500	550	550	n/a	---	---	---	
RAM 2500HD	4x4	Quad Cab	No	8.0 Box	8.0L V10	5200	6500	8800	67980	23	450	500	450	500	450	550	550	600	600	n/a	---	---	---	
RAM 2500HD	4x4	All	No	Chassis	All	All	All	8501	67980	23	?	?	?	?	?	?	?	?	?	n/a	---	---	---	
RAM 3500	4x4	Reg Cab	Yes	8.0 Box	5.9L V8	4850	7500	10500	67980	23	---	---	---	---	0	---	---	0	0	n/a	---	---	---	
RAM 3500	4x4	Reg Cab	Yes	8.0 Box	8.0L V10	4850	7500	10500	67980	23	---	---	---	---	350	---	---	700	800	n/a	---	---	---	
RAM 3500	4x4	Quad Cab	Yes	8.0 Box	5.9L D	5200	7500	10500	67980	23	---	---	---	---	650	---	---	---	---	n/a	---	---	---	
RAM 3500	4x4	Quad Cab	Yes	8.0 Box	5.9L V8	5200	7500	10500	67980	23	---	---	---	---	250	---	---	350	350	n/a	---	---	---	
RAM 3500	4x4	Quad Cab	Yes	8.0 Box	8.0L V10	5200	7500	10500	67980	23	---	---	---	---	300	---	---	400	450	n/a	---	---	---	
RAM 3500	4x4	All	Yes	Chassis	All	All	All	8501	67980	23	---	---	---	---	?	---	---	?	?	n/a	---	---	---	
RAM 3500	4x2	Reg Cab	Yes	8.0 Box	5.9L V8	4500	7500	10500	67980	23	---	---	---	---	150	---	---	250	300	n/a	---	---	---	
RAM 3500	4x2	Reg Cab	Yes	8.0 Box	8.0L V10	4500	7500	10500	67980	23	---	---	---	---	250	---	---	650	750	n/a	---	---	---	
RAM 3500	4x2	Quad Cab	Yes	8.0 Box	5.9L V8	4500	7500	10500	67980	23	---	---	---	---	150	---	---	250	350	n/a	---	---	---	
RAM 3500	4x2	Quad Cab	Yes	8.0 Box	8.0L V10	4500	7500	10500	67980	23	---	---	---	---	1000	---	---	---	---	n/a	---	---	---	
RAM 3500	4x2	All	Yes	Chassis	All	All	All	10001	67980	23	---	---	---	---	?	---	---	?	?	n/a	---	---	---	

- Notes:
- Ballast amounts are based on a "Representative Vehicle," defined in the vehicle selection guide instructions, and must be modified for all other configurations for axle and GVWR compliance.
 - Requires bumper notching on Sport and LE Sport option.

2001 Dodge

Section 3

MVP® & MVP PLUS™ Blades

MVP®	MVP PLUS™					
8'-6" STEEL	7'-6" STEEL	7'-6" POLY	8'-6" STEEL	8'-6" POLY	9'-6" STEEL	9'-6" POLY
IUMVP85	IUTHVPP75	IUTHVPPY75	IUTHVPP85	IUTHVPPY85	IUTHVPP95	IUTHVPPY95
Blade Assembly	63919	44475	44575	44485	44585	44495
AQ&L Assembly Box 1	63910					
AQ&L Assembly Box 2	67951-2	44225				
Hydraulic Kit	64777					
Light Kit	28800					
Choose a Joystick Control or Hand-Held Control	96369	96700				
	96462	96600				

Model	Body Style	DRW	Box Option	Engine Type	Min F G A W R	Min R G A W R	Min G V W R	Harness Kit	UltraMount® system		67980	23	850	750	700	800	750	---	1000
									Mount Kit	Notes									
RAM 2500HD	4x4	Reg Cab	No	8.0 Box	5.9L D	5200	6500	8800			67980	23	850	750	700	800	750	---	1000
RAM 2500HD	4x4	Reg Cab	No	8.0 Box	5.9L V8	5200	6200	8800			67980	23	650	500	500	550	550	700	650
RAM 2500HD	4x4	Reg Cab	No	8.0 Box	8.0L V10	5200	6500	8800			67980	23	700	600	550	650	600	750	700
RAM 2500HD	4x4	Quad Cab	No	6.5 Box	5.9L D	5200	6500	8800			67980	23	---	700	650	---	850	---	---
RAM 2500HD	4x4	Quad Cab	No	6.5 Box	5.9L V8	5200	6200	8800			67980	23	550	450	400	500	450	600	550
RAM 2500HD	4x4	Quad Cab	No	6.5 Box	8.0L V10	5200	6500	8800			67980	23	600	500	500	550	500	650	650
RAM 2500HD	4x4	Quad Cab	No	8.0 Box	5.9L D	5200	6500	8800			67980	23	---	---	1000	---	---	---	---
RAM 2500HD	4x4	Quad Cab	No	8.0 Box	5.9L V8	5200	6200	8800			67980	23	600	500	450	550	500	650	600
RAM 2500HD	4x4	Quad Cab	No	8.0 Box	8.0L V10	5200	6500	8800			67980	23	650	550	500	600	550	900	650
RAM 2500HD	4x4	All	No	Chassis	All	All	All	8501	HB1 use 8436 or HB5/HB1 use 8442		67980	23	?	?	?	?	?	?	?
RAM 3500	4x4	Reg Cab	Yes	8.0 Box	5.9L V8	4850	7500	10500			67980	23	50	---	---	0	0	100	100
RAM 3500	4x4	Reg Cab	Yes	8.0 Box	8.0L V10	4850	7500	10500			67980	23	---	---	---	800	650	---	---
RAM 3500	4x4	Quad Cab	Yes	8.0 Box	5.9L V8	5200	7500	10500			67980	23	400	---	---	350	300	450	400
RAM 3500	4x4	Quad Cab	Yes	8.0 Box	8.0L V10	5200	7500	10500			67980	23	600	---	---	400	400	---	850
RAM 3500	4x4	All	Yes	Chassis	All	All	All	8501			67980	23	?	---	---	?	?	?	?
RAM 3500	4x2	Reg Cab	Yes	8.0 Box	5.9L V8	4500	7500	10500			67980	23	350	---	---	250	250	400	350
RAM 3500	4x2	Reg Cab	Yes	8.0 Box	8.0L V10	4500	7500	10500			67980	23	1000	---	---	750	550	---	---
RAM 3500	4x2	Quad Cab	Yes	8.0 Box	5.9L V8	4500	7500	10500			67980	23	700	---	---	400	250	---	950
RAM 3500	4x2	All	Yes	Chassis	All	All	All	10001			67980	23	?	---	---	?	?	?	?

- Notes:**
- Ballast amounts are based on a "Representative Vehicle," defined in the vehicle selection guide instructions, and must be modified for all other configurations for axle and GVWR compliance.
 - Requires bumper notching on Sport and LE Sport option.

2001 Ford

Section 1 Suburbanite™ & MIDWEIGHT™ Blades

	
Suburbanite™	
6'-8" POLY	7'-4" POLY
SUB68	SUB74
Plow Blade Assembly AQ&L Assembly Box 1 AQ&L Assembly Box 2 Hydraulic Kit Light Kit Choose a Joystick Control or Hand-Held Control	
27546	27548
27550	
n/a	
27516	
64100	
56369	
56462	

	
MIDWEIGHT™	
7'-6" STEEL	7'-6" POLY
IUTH75	IUTHY75
64340	64330
64336	
67992	
64620	
28800	
56369	
56462	

Model	Body Style	DRW	Box Option	Engine Type	Min F G A W R	Min R G A W R	Min G V W R	Harness Kit	Personal Plow system		Ballast Guidelines, lbs (1)		UltraMount® system		Ballast Guidelines, lbs (1)	
									Mount Kit	Notes			Mount Kit	Notes		
EXPLORER	AWD	SU-4DR	No	---	5.0L V8	2850	3000	5640	1203	3,8	200	300	n/a	---	---	---
EXPLORER	AWD	SU-4DR	No	---	5.0L V8	2850	3000	5540	1203	3,8	200	300	n/a	---	---	---
EXPLORER	AWD	SU-4DR	No	---	5.0L V8	2850	2950	5640	1203	3,8	200	300	n/a	---	---	---
EXPLORER	AWD	SU-4DR	No	---	5.0L V8	2850	2950	5540	1203	3,8	200	300	n/a	---	---	---
EXPLORER	AWD	SU-4DR	No	---	5.0L V8	2850	2900	5640	1203	3,8	200	300	n/a	---	---	---
EXPLORER	AWD	SU-4DR	No	---	5.0L V8	2850	2900	5540	1203	3,8	200	300	n/a	---	---	---
EXPLORER	4x4	SU-2DR	No	---	4.0L V6	2620	2900	5020	1203	3,8	250	---	n/a	---	---	---
EXPLORER	4x4	SU-2DR	No	---	4.0L V6	2620	2900	4880	1203	3,8	250	---	n/a	---	---	---
EXPLORER	4x4	SU-2DR	No	---	4.0L V6	2620	2650	5020	1203	3,8	250	---	n/a	---	---	---
EXPLORER	4x4	SU-2DR	No	---	4.0L V6	2620	2650	4880	1203	3,8	250	---	n/a	---	---	---
EXPLORER	4x4	SU-4DR	No	---	4.0L V6	2850	2950	5440	1203	3,8	0	0	n/a	---	---	---
EXPLORER	4x4	SU-4DR	No	---	4.0L V6	2850	2950	5340	1203	3,8	0	0	n/a	---	---	---
EXPLORER	4x4	SU-4DR	No	---	4.0L V6	2850	2900	5440	1203	3,8	0	0	n/a	---	---	---
EXPLORER	4x4	SU-4DR	No	---	4.0L V6	2850	2900	5340	1203	3,8	0	0	n/a	---	---	---
EXPLORER	4x4	SU-4DR	No	---	4.0L V6	2800	2950	5440	1203	3,8	0	0	n/a	---	---	---
EXPLORER	4x4	SU-4DR	No	---	4.0L V6	2800	2950	5340	1203	3,8	0	0	n/a	---	---	---
EXPLORER	4x4	SU-4DR	No	---	4.0L V6	2800	2900	5440	1203	3,8	0	0	n/a	---	---	---
EXPLORER	4x4	SU-4DR	No	---	4.0L V6	2800	2900	5340	1203	3,8	0	0	n/a	---	---	---
EXPLORER	4x4	SU-4DR	No	---	4.0L V6	2710	2950	5440	1203	3,8	250	---	n/a	---	---	---
EXPLORER	4x4	SU-4DR	No	---	4.0L V6	2710	2950	5340	1203	3,8	250	---	n/a	---	---	---
EXPLORER	4x4	SU-4DR	No	---	4.0L V6	2710	2900	5440	1203	3,8	250	---	n/a	---	---	---
EXPLORER	4x4	SU-4DR	No	---	4.0L V6	2710	2900	5340	1203	3,8	300	---	n/a	---	---	---
EXPLORER SPORT TRAC	4x4	---	No	4.0 Box	4.0L V6	2900	2900	5840	1203	3,8	550	---	n/a	---	---	---
EXPLORER SPORT TRAC	4x4	---	No	4.0 Box	4.0L V6	2900	2900	5580	1203	3,8	550	---	n/a	---	---	---
EXPEDITION	4x4	SU-4DR	No	---	4.6L V8	3450	4128	6980	1223	3,8	---	0	67810	2,10	---	---
EXPEDITION	4x4	SU-4DR	No	---	4.6L V8	3450	3900	6980	1223	3,8	---	0	67810	2,10	---	---
EXPEDITION	4x4	SU-4DR	No	---	5.4L V8	3450	4200	7200	1223	3,8	---	250	67810	2,10	---	---
EXPEDITION	4x4	SU-4DR	No	---	5.4L V8	3450	4128	7200	1223	3,8	---	250	67810	2,10	---	---
EXCURSION	4x4	SU-4DR	No	---	5.4L V8	4700	5250	8900	n/a	---	---	---	67982	2	0	0
EXCURSION	4x4	SU-4DR	No	---	6.8L V10	4700	5250	8900	n/a	---	---	---	67982	2	0	0

HB5 use
8436

- Notes:**
- Ballast amounts are based on a "Representative Vehicle," defined in the vehicle selection guide instructions, and must be modified for all other configurations for axle and GVWR compliance.
 - Recommended snowplow prep package whenever available.

- Requires bumper notching.
- These Snowplows Are For Personal/Homeowner Use Only.
- May require bumper or air dam notching.

2001 Ford

Section 1 Suburbanite™ & MIDWEIGHT™ Blades

 Suburbanite™	
6'-8" POLY	7'-4" POLY
SUB68	SUB74
Plow Blade Assembly	27546 27548
AQ&L Assembly Box 1	27550
AQ&L Assembly Box 2	n/a
Hydraulic Kit	27516
Light Kit	64100
Choose a Joystick Control	56369
or Hand-Held Control	56462

 UltraMount™	
MIDWEIGHT™	
7'-6" STEEL	7'-6" POLY
IUTH75	IUTHY75
64340	64330
64336	
67992	
64620	
28800	
56369	
56462	

Model	4x4	Body Style	DRW	Box Option	Engine Type	Min F G A W R	Min R G A W R	Min G V W R	Harness Kit	Personal Plow system		Ballast Guidelines, lbs (1)		UltraMount® system		Ballast Guidelines, lbs (1)	
										Mount Kit	Notes			Mount Kit	Notes		
RANGER	4x4	Reg Cab	No	6.0 Box	3.0L V6	2710	2750	4980		1203	8,10	150	150	n/a	---	---	---
RANGER	4x4	Reg Cab	No	6.0 Box	3.0L V6	2710	2750	4760		1203	8,10	150	150	n/a	---	---	---
RANGER	4x4	Reg Cab	No	6.0 Box	3.0L V6	2710	2600	4980		1203	8,10	150	150	n/a	---	---	---
RANGER	4x4	Reg Cab	No	6.0 Box	3.0L V6	2710	2600	4760		1203	8,10	150	150	n/a	---	---	---
RANGER	4x4	Reg Cab	No	6.0 Box	3.0L V6	2510	2750	4980		1203	8,10	650	800	n/a	---	---	---
RANGER	4x4	Reg Cab	No	6.0 Box	3.0L V6	2510	2750	4760		1203	8,10	650	---	n/a	---	---	---
RANGER	4x4	Reg Cab	No	6.0 Box	3.0L V6	2510	2600	4980		1203	8,10	650	---	n/a	---	---	---
RANGER	4x4	Reg Cab	No	6.0 Box	3.0L V6	2510	2600	4760		1203	8,10	650	---	n/a	---	---	---
RANGER	4x4	Reg Cab	No	6.0 Box	4.0L V6	2710	2750	4980		1203	8,10	150	150	n/a	---	---	---
RANGER	4x4	Reg Cab	No	6.0 Box	4.0L V6	2710	2750	4760		1203	8,10	150	150	n/a	---	---	---
RANGER	4x4	Reg Cab	No	6.0 Box	4.0L V6	2710	2600	4980		1203	8,10	150	150	n/a	---	---	---
RANGER	4x4	Reg Cab	No	6.0 Box	4.0L V6	2710	2600	4760		1203	8,10	150	150	n/a	---	---	---
RANGER	4x4	Reg Cab	No	6.0 Box	4.0L V6	2510	2750	4980		1203	8,10	800	---	n/a	---	---	---
RANGER	4x4	Reg Cab	No	7.0 Box	3.0L V6	2710	2750	5020		1203	8,10	100	100	n/a	---	---	---
RANGER	4x4	Reg Cab	No	7.0 Box	3.0L V6	2710	2750	4820		1203	8,10	100	100	n/a	---	---	---
RANGER	4x4	Reg Cab	No	7.0 Box	3.0L V6	2710	2600	5020		1203	8,10	100	100	n/a	---	---	---
RANGER	4x4	Reg Cab	No	7.0 Box	3.0L V6	2710	2600	4820		1203	8,10	100	100	n/a	---	---	---
RANGER	4x4	Reg Cab	No	7.0 Box	3.0L V6	2510	2750	5020		1203	8,10	600	700	n/a	---	---	---
RANGER	4x4	Reg Cab	No	7.0 Box	3.0L V6	2510	2750	4820	HB5 use 8436	1203	8,10	600	---	n/a	---	---	---
RANGER	4x4	Reg Cab	No	7.0 Box	3.0L V6	2510	2600	5020		1203	8,10	600	---	n/a	---	---	---
RANGER	4x4	Reg Cab	No	7.0 Box	3.0L V6	2510	2600	4820		1203	8,10	600	---	n/a	---	---	---
RANGER	4x4	Reg Cab	No	7.0 Box	4.0L V6	2710	2750	5020		1203	8,10	100	100	n/a	---	---	---
RANGER	4x4	Reg Cab	No	7.0 Box	4.0L V6	2710	2750	4820		1203	8,10	100	100	n/a	---	---	---
RANGER	4x4	Reg Cab	No	7.0 Box	4.0L V6	2710	2600	5020		1203	8,10	100	100	n/a	---	---	---
RANGER	4x4	Reg Cab	No	7.0 Box	4.0L V6	2710	2600	4820		1203	8,10	100	100	n/a	---	---	---
RANGER	4x4	Reg Cab	No	7.0 Box	4.0L V6	2510	2750	5020		1203	8,10	750	---	n/a	---	---	---
RANGER	4x4	Super Cab	No	6.0 Box	3.0L V6	2850	2750	5140		1203	8,10	100	150	n/a	---	---	---
RANGER	4x4	Super Cab	No	6.0 Box	3.0L V6	2850	2750	5080		1203	8,10	100	150	n/a	---	---	---
RANGER	4x4	Super Cab	No	6.0 Box	3.0L V6	2710	2750	5140		1203	8,10	300	400	n/a	---	---	---
RANGER	4x4	Super Cab	No	6.0 Box	3.0L V6	2710	2750	5080		1203	8,10	300	400	n/a	---	---	---
RANGER	4x4	Super Cab	No	6.0 Box	3.0L V6	2710	2600	5140		1203	8,10	300	400	n/a	---	---	---
RANGER	4x4	Super Cab	No	6.0 Box	3.0L V6	2710	2600	5080		1203	8,10	300	400	n/a	---	---	---
RANGER	4x4	Super Cab	No	6.0 Box	4.0L V6	2850	2750	5140		1203	8,10	100	150	n/a	---	---	---
RANGER	4x4	Super Cab	No	6.0 Box	4.0L V6	2850	2750	5080		1203	8,10	100	150	n/a	---	---	---
RANGER	4x4	Super Cab	No	6.0 Box	4.0L V6	2710	2750	5140		1203	8,10	450	600	n/a	---	---	---
RANGER	4x4	Super Cab	No	6.0 Box	4.0L V6	2710	2750	5080		1203	8,10	450	600	n/a	---	---	---
RANGER	4x4	Super Cab	No	6.0 Box	4.0L V6	2710	2600	5140		1203	8,10	450	600	n/a	---	---	---
RANGER	4x4	Super Cab	No	6.0 Box	4.0L V6	2710	2600	5080		1203	8,10	450	600	n/a	---	---	---

Notes:
1. Ballast amounts are based on a "Representative Vehicle," defined in the vehicle selection guide instructions, and must be modified for all other configurations for axle and GVWR compliance.

8. These Snowplows Are For Personal/Homeowner Use Only.
10. May require bumper or air dam notching.

2001 Ford

Section 1 Suburbanite™ & MIDWEIGHT™ Blades

	
Suburbanite™	
6'-8" POLY	7'-4" POLY
SUB68	SUB74
Plow	
Blade Assembly	27546 27548
AQ&L Assembly Box 1	27550
AQ&L Assembly Box 2	n/a
Hydraulic Kit	27516
Light Kit	64100
Choose a Joystick Control or Hand-Held Control	56369 56462

	
MIDWEIGHT™	
7'-6" STEEL	7'-6" POLY
IUTH75	IUTHY75
	64340 64330
	64336
	67992
	64620
	28800
	56369
	56462

Model	Body Style	DRW	Box Option	Engine Type	Min FGAWR	Min RGAWR	Min GVWR	Harness Kit	Personal Plow system		Ballast Guidelines, lbs (1)	UltraMount® system		Ballast Guidelines, lbs (1)		
									Mount Kit	Notes		Mount Kit	Notes			
F150	4x4	Reg Cab	No	6.5 Box	4.2L V6	3680	3550	6000	1223	8	---	0	67810	2,10	300	300
F150	4x4	Reg Cab	No	6.5 Box	4.2L V6	3660	3550	6000	1223	8	---	0	67810	2,10	300	300
F150	4x4	Reg Cab	No	6.5 Box	4.2L V6	3400	3550	6000	1223	8	---	0	67810	2,10	650	600
F150	4x4	Reg Cab	No	6.5 Box	4.2L V6	3200	3550	6000	1223	8	---	0	67810	2,10	---	---
F150	4x4	Reg Cab	No	6.5 Box	4.2L V6	3000	3550	6000	1223	8	---	550	67810	2,10	---	---
F150	4x4	Reg Cab	No	6.5 Box	4.6L V8	3680	3550	6250	1223	8	---	50	67810	2,10	350	350
F150	4x4	Reg Cab	No	6.5 Box	4.6L V8	3680	3550	6000	1223	8	---	50	67810	2,10	300	300
F150	4x4	Reg Cab	No	6.5 Box	4.6L V8	3660	3550	6250	1223	8	---	50	67810	2,10	350	350
F150	4x4	Reg Cab	No	6.5 Box	4.6L V8	3660	3550	6000	1223	8	---	50	67810	2,10	300	300
F150	4x4	Reg Cab	No	6.5 Box	4.6L V8	3400	3550	6000	1223	8	---	50	67810	2,10	---	---
F150	4x4	Reg Cab	No	6.5 Box	4.6L V8	3200	3550	6250	1223	8	---	150	67810	2,10	---	---
F150	4x4	Reg Cab	No	6.5 Box	4.6L V8	3200	3550	6000	1223	8	---	100	67810	2,10	---	---
F150	4x4	Reg Cab	No	6.5 Box	4.6L V8	3000	3550	6250	1223	8	---	850	67810	2,10	---	---
F150	4x4	Reg Cab	No	6.5 Box	4.6L V8	3000	3550	6000	1223	8	---	800	67810	2,10	---	---
F150	4x4	Reg Cab	No	6.5 Box	5.4L V8	3680	3550	6300	1223	8	---	0	67810	2,10	250	250
F150	4x4	Reg Cab	No	6.5 Box	5.4L V8	3680	3550	6250	1223	8	---	50	67810	2,10	450	400
F150	4x4	Reg Cab	No	6.5 Box	5.4L V8	3680	3550	6000	1223	8	---	50	67810	2,10	300	300
F150	4x4	Reg Cab	No	6.5 Box	5.4L V8	3660	3550	6300	1223	8	---	0	67810	2,10	300	250
F150	4x4	Reg Cab	No	6.5 Box	5.4L V8	3660	3550	6250	1223	8	---	50	67810	2,10	500	450
F150	4x4	Reg Cab	No	6.5 Box	5.4L V8	3660	3550	6000	1223	8	---	50	67810	2,10	350	300
F150	4x4	Reg Cab	No	6.5 Box	5.4L V8	3400	3550	6300	1223	8	---	0	67810	2,10	---	---
F150	4x4	Reg Cab	No	6.5 Box	5.4L V8	3400	3550	6250	1223	8	---	50	67810	2,10	---	---
F150	4x4	Reg Cab	No	6.5 Box	5.4L V8	3400	3550	6000	1223	8	---	50	67810	2,10	---	---
F150	4x4	Reg Cab	No	6.5 Box	5.4L V8	3200	3550	6300	1223	8	---	400	67810	2,10	---	---
F150	4x4	Reg Cab	No	6.5 Box	5.4L V8	3200	3550	6250	1223	8	---	600	67810	2,10	---	---
F150	4x4	Reg Cab	No	6.5 Box	5.4L V8	3200	3550	6000	1223	8	---	450	67810	2,10	---	---
F150	4x4	Reg Cab	No	8.0 Box	4.2L V6	3680	3550	6000	1223	8	---	100	67810	2,10	350	350
F150	4x4	Reg Cab	No	8.0 Box	4.2L V6	3660	3550	6000	1223	8	---	100	67810	2,10	350	350
F150	4x4	Reg Cab	No	8.0 Box	4.2L V6	3400	3550	6000	1223	8	---	100	67810	2,10	---	---
F150	4x4	Reg Cab	No	8.0 Box	4.2L V6	3200	3550	6000	1223	8	---	250	67810	2,10	---	---

HB5 use
8436

- Notes:**
- Ballast amounts are based on a "Representative Vehicle," defined in the vehicle selection guide instructions, and must be modified for all other configurations for axle and GVWR compliance.
 - Recommended snowplow prep package whenever available.

- These Snowplows Are For Personal/Homeowner Use Only.
- May require bumper or air dam notching.

2001 Ford

Section 1 Suburbanite™ & MIDWEIGHT™ Blades

 Suburbanite™	
6'-8" POLY SUB68	7'-4" POLY SUB74
Plow Blade Assembly 27546 27548	
AQ&L Assembly Box 1 27550	
AQ&L Assembly Box 2 n/a	
Hydraulic Kit 27516	
Light Kit 64100	
Choose a Joystick Control 56369	
or Hand-Held Control 56462	

 MIDWEIGHT™	
7'-6" STEEL IUTH75	7'-6" POLY IUTHY75
64340 64330	
64336	
67992	
64620	
28800	
56369	
56462	

Model	Body Style	DRW	Box Option	Engine Type	Min F G A W R	Min R G A W R	Min G V W R	Harness Kit	Personal Plow system		Ballast Guidelines, lbs (1)	UltraMount® system		Ballast Guidelines, lbs (1)		
									Mount Kit	Notes		Mount Kit	Notes			
F150	4x4	Reg Cab	No	8.0 Box	4.6L V8	3680	3550	6250	1223	8	---	150	67810	2,10	400	400
F150	4x4	Reg Cab	No	8.0 Box	4.6L V8	3680	3550	6000	1223	8	---	100	67810	2,10	400	350
F150	4x4	Reg Cab	No	8.0 Box	4.6L V8	3660	3550	6250	1223	8	---	150	67810	2,10	450	400
F150	4x4	Reg Cab	No	8.0 Box	4.6L V8	3660	3550	6000	1223	8	---	100	67810	2,10	400	350
F150	4x4	Reg Cab	No	8.0 Box	4.6L V8	3400	3550	6250	1223	8	---	150	67810	2,10	---	---
F150	4x4	Reg Cab	No	8.0 Box	4.6L V8	3400	3550	6000	1223	8	---	100	67810	2,10	---	---
F150	4x4	Reg Cab	No	8.0 Box	4.6L V8	3200	3550	6250	1223	8	---	650	67810	2,10	---	---
F150	4x4	Reg Cab	No	8.0 Box	4.6L V8	3200	3550	6000	1223	8	---	550	67810	2,10	---	---
F150	4x4	Reg Cab	No	8.0 Box	5.4L V8	4150	4800	7700	1223	8	---	0	67810	2,10	250	250
F150	4x4	Reg Cab	No	8.0 Box	5.4L V8	3680	3550	6300	1223	8	---	100	67810	2,10	---	---
F150	4x4	Reg Cab	No	8.0 Box	5.4L V8	3680	3550	6250	1223	8	---	100	67810	2,10	---	---
F150	4x4	Reg Cab	No	8.0 Box	5.4L V8	3680	3550	6000	1223	8	---	100	67810	2,10	---	---
F150	4x4	Reg Cab	No	8.0 Box	5.4L V8	3660	3550	6300	1223	8	---	100	67810	2,10	---	---
F150	4x4	Reg Cab	No	8.0 Box	5.4L V8	3660	3550	6250	1223	8	---	100	67810	2,10	---	---
F150	4x4	Reg Cab	No	8.0 Box	5.4L V8	3660	3550	6000	1223	8	---	100	67810	2,10	---	---
F150	4x4	Reg Cab	No	8.0 Box	5.4L V8	3400	3550	6300	1223	8	---	200	67810	2,10	---	---
F150	4x4	Reg Cab	No	8.0 Box	5.4L V8	3400	3550	6250	1223	8	---	300	67810	2,10	---	---
F150	4x4	Reg Cab	No	8.0 Box	5.4L V8	3400	3550	6000	1223	8	---	150	67810	2,10	---	---
F150	4x4	Super Cab	No	6.5 Box	4.6L V8	3680	3550	6250	1223	8	---	50	67810	2,10	400	350
F150	4x4	Super Cab	No	6.5 Box	4.6L V8	3660	3550	6250	1223	8	---	50	67810	2,10	500	450
F150	4x4	Super Cab	No	6.5 Box	4.6L V8	3400	3550	6250	1223	8	---	50	67810	2,10	---	---
F150	4x4	Super Cab	No	6.5 Box	4.6L V8	3200	3550	6250	1223	8	---	700	67810	2,10	---	---
F150	4x4	Super Cab	No	6.5 Box	5.4L V8	4150	4800	7700	1223	8	---	0	67810	2,10	250	250
F150	4x4	Super Cab	No	6.5 Box	5.4L V8	3680	3550	6500	1223	8	---	50	67810	2,10	---	---
F150	4x4	Super Cab	No	6.5 Box	5.4L V8	3680	3550	6250	1223	8	---	50	67810	2,10	---	---
F150	4x4	Super Cab	No	6.5 Box	5.4L V8	3660	3550	6500	1223	8	---	50	67810	2,10	---	---
F150	4x4	Super Cab	No	6.5 Box	5.4L V8	3400	3550	6500	1223	8	---	450	67810	2,10	---	---
F150	4x4	Super Cab	No	6.5 Box	5.4L V8	3400	3550	6250	1223	8	---	400	67810	2,10	---	---
F150	4x4	Super Cab	No	8.0 Box	4.6L V8	3680	3550	6250	1223	8	---	100	67810	2,10	---	---
F150	4x4	Super Cab	No	8.0 Box	4.6L V8	3660	3550	6250	1223	8	---	100	67810	2,10	---	---
F150	4x4	Super Cab	No	8.0 Box	4.6L V8	3400	3550	6250	1223	8	---	400	67810	2,10	---	---
F150	4x4	Super Cab	No	8.0 Box	5.4L V8	3680	3550	6500	1223	8	---	100	67810	2,10	---	---
F150	4x4	Super Cab	No	8.0 Box	5.4L V8	3680	3550	6250	1223	8	---	100	67810	2,10	---	---
F150	4x4	Super Cab	No	8.0 Box	5.4L V8	3660	3550	6250	1223	8	---	100	67810	2,10	---	---
F150	4x4	SuperCrew	No	5.5 Box	4.6L V8	3600	3800	6500	1223	8	---	0	67810	2,10	---	---
F150	4x4	SuperCrew	No	5.5 Box	5.4L V8	3600	3800	6750	1223	8	---	0	67810	2,10	---	---

HB5 use
8436

- Notes:**
- Ballast amounts are based on a "Representative Vehicle," defined in the vehicle selection guide instructions, and must be modified for all other configurations for axle and GVWR compliance.
 - Recommended snowplow prep package whenever available.

- These Snowplows Are For Personal/Homeowner Use Only.
- May require bumper or air dam notching.

2001 Ford

Section 1 Suburbanite™ & MIDWEIGHT™ Blades

	
Suburbanite™	
6'-8" POLY	7'-4" POLY
SUB68	SUB74
Plow Blade Assembly AQ&L Assembly Box 1 AQ&L Assembly Box 2 Hydraulic Kit Light Kit	
27546	27548
27550	
n/a	
27516	
64100	
56369	
56462	

	
MIDWEIGHT™	
7'-6" STEEL	7'-6" POLY
IUTH75	IUTHY75
64340	64330
64336	
67992	
64620	
28800	
56369	
56462	

Model	Body Style	DRW	Box Option	Engine Type	Min F G A W R	Min R G A W R	Min G V W R	Harness Kit	Personal Plow system		Ballast Guidelines, lbs (1)	UltraMount® system		Ballast Guidelines, lbs (1)	
									Mount Kit	Notes		Mount Kit	Notes		
F250 SUPER DUTY	4x4	Reg Cab	No	8.0 Box	5.4L V8	5200	6084	8800	n/a	---	---	67982	2	300	300
F250 SUPER DUTY	4x4	Reg Cab	No	8.0 Box	5.4L V8	4800	6084	8800	n/a	---	---	67982	2	300	300
F250 SUPER DUTY	4x4	Reg Cab	No	8.0 Box	5.4L V8	4400	6084	8800	n/a	---	---	67982	2	300	300
F250 SUPER DUTY	4x4	Reg Cab	No	8.0 Box	6.8L V10	5200	6084	8800	n/a	---	---	67982	2	350	350
F250 SUPER DUTY	4x4	Reg Cab	No	8.0 Box	6.8L V10	4800	6084	8800	n/a	---	---	67982	2	350	350
F250 SUPER DUTY	4x4	Reg Cab	No	8.0 Box	6.8L V10	4400	6084	8800	n/a	---	---	67982	2	600	550
F250 SUPER DUTY	4x4	Reg Cab	No	8.0 Box	7.3L D	5200	6084	8800	n/a	---	---	67982	2	550	550
F250 SUPER DUTY	4x4	Reg Cab	No	8.0 Box	7.3L D	4800	6084	8800	n/a	---	---	67982	2	750	700
F250 SUPER DUTY	4x4	Super Cab	No	7.0 Box	5.4L V8	5200	6084	8800	n/a	---	---	67982	2	300	300
F250 SUPER DUTY	4x4	Super Cab	No	7.0 Box	5.4L V8	4800	6084	8800	n/a	---	---	67982	2	300	300
F250 SUPER DUTY	4x4	Super Cab	No	7.0 Box	5.4L V8	4400	6084	8800	n/a	---	---	67982	2	300	300
F250 SUPER DUTY	4x4	Super Cab	No	7.0 Box	6.8L V10	5200	6084	8800	n/a	---	---	67982	2	400	350
F250 SUPER DUTY	4x4	Super Cab	No	7.0 Box	6.8L V10	4800	6084	8800	n/a	---	---	67982	2	350	350
F250 SUPER DUTY	4x4	Super Cab	No	7.0 Box	6.8L V10	4400	6084	8800	n/a	---	---	67982	2	850	800
F250 SUPER DUTY	4x4	Super Cab	No	7.0 Box	7.3L D	5200	6084	8800	n/a	---	---	67982	2	550	550
F250 SUPER DUTY	4x4	Super Cab	No	7.0 Box	7.3L D	4800	6084	8800	n/a	---	---	67982	2	1000	950
F250 SUPER DUTY	4x4	Super Cab	No	8.0 Box	5.4L V8	5200	6084	8800	n/a	---	---	67982	2	300	300
F250 SUPER DUTY	4x4	Super Cab	No	8.0 Box	5.4L V8	4800	6084	8800	n/a	---	---	67982	2	300	250
F250 SUPER DUTY	4x4	Super Cab	No	8.0 Box	5.4L V8	4400	6084	8800	n/a	---	---	67982	2	750	700
F250 SUPER DUTY	4x4	Super Cab	No	8.0 Box	6.8L V10	5200	6084	8800	n/a	---	---	67982	2	350	350
F250 SUPER DUTY	4x4	Super Cab	No	8.0 Box	6.8L V10	4800	6084	8800	n/a	---	---	67982	2	350	350
F250 SUPER DUTY	4x4	Super Cab	No	8.0 Box	7.3L D	5200	6084	8800	n/a	---	---	67982	2	500	500
F250 SUPER DUTY	4x4	Crew Cab	No	7.0 Box	5.4L V8	5200	6084	8800	n/a	---	---	67982	2	250	250
F250 SUPER DUTY	4x4	Crew Cab	No	7.0 Box	5.4L V8	4800	6084	8800	n/a	---	---	67982	2	250	250
F250 SUPER DUTY	4x4	Crew Cab	No	7.0 Box	5.4L V8	4400	6084	8800	n/a	---	---	67982	2	900	850
F250 SUPER DUTY	4x4	Crew Cab	No	7.0 Box	6.8L V10	5200	6084	8800	n/a	---	---	67982	2	300	300
F250 SUPER DUTY	4x4	Crew Cab	No	7.0 Box	6.8L V10	4800	6084	8800	n/a	---	---	67982	2	300	300
F250 SUPER DUTY	4x4	Crew Cab	No	7.0 Box	6.8L V10	4400	6084	8800	n/a	---	---	67982	2	300	300
F250 SUPER DUTY	4x4	Crew Cab	No	7.0 Box	7.3L D	5200	6084	8800	n/a	---	---	67982	2	450	450
F250 SUPER DUTY	4x4	Crew Cab	No	8.0 Box	5.4L V8	5200	6084	8800	n/a	---	---	67982	2	250	250
F250 SUPER DUTY	4x4	Crew Cab	No	8.0 Box	5.4L V8	4800	6084	8800	n/a	---	---	67982	2	250	250
F250 SUPER DUTY	4x4	Crew Cab	No	8.0 Box	6.8L V10	5200	6084	8800	n/a	---	---	67982	2	300	300
F250 SUPER DUTY	4x4	Crew Cab	No	8.0 Box	6.8L V10	4800	6084	8800	n/a	---	---	67982	2	300	300
F250 SUPER DUTY	4x4	Crew Cab	No	8.0 Box	6.8L V10	4400	6084	8800	n/a	---	---	67982	2	300	300
F250 SUPER DUTY	4x4	Crew Cab	No	8.0 Box	7.3L D	5200	6084	8800	n/a	---	---	67982	2	500	450
F250 SUPER DUTY	4x4	All	No	Chassis	All	All	All	8501	n/a	---	---	67982	2	?	?

- Notes:**
- Ballast amounts are based on a "Representative Vehicle," defined in the vehicle selection guide instructions, and must be modified for all other configurations for axle and GVWR compliance.
 - Recommended snowplow prep package whenever available.

2001 Ford

Section 2 PRO-PLOW®, PRO PLUS® & Heavy Weight Blades

UltraMount																			UniMount	
PRO-PLOW®										PRO PLUS®									Heavy Weight	
7'-6" STEEL	7'-6" POLY	8'-0" STEEL	8'-0" POLY	8'-6" STEEL	7'-6" STEEL	8'-0" STEEL	8'-6" STEEL	9'-0" STEEL		9'-0" STEEL	10'-0" STEEL									
IUTP75	IUTP75	IUTP80	IUTPY80	IUTP85	IUTPP75	IUTPP80	IUTPP85	IUTPP90		IUHW90	IUHW10									
60381	62400	60390	62450	60308	64750	66980	66974	66901		62301	62302									
67950					66490				62298-1											
67951-2					64999				62299-1											
64588					28800				64400											
28800					56369				28800											
56369					56462				56369											
56462									56462											

Model	Body Style	DRW	Box Option	Engine Type	Min F G A W R	Min R G A W R	Min G V W R	Harness Kit	UltraMount® system		Ballast Guidelines, lbs (1)										UniMount® system		Ballast Guidelines, lbs (1)		
									Mount Kit	Notes	Mount Kit	Notes	Mount Kit	Notes	Mount Kit	Notes	Mount Kit	Notes							
EXCURSION	4x4	SU-4DR	No	---	5.4L V8	4700	5250	8900	HB5 use 8436	67982	2	0	50	0	100	---	---	---	---	---	n/a	---	---	---	
EXCURSION	4x4	SU-4DR	No	---	6.8L V10	4700	5250	8900		67982	2	200	---	300	---	---	---	---	---	---	---	n/a	---	---	---
F150	4x4	Reg Cab	No	6.5 Box	4.2L V6	3680	3550	6000		67810	2,10	400	---	500	---	---	---	---	---	---	n/a	---	---	---	
F150	4x4	Reg Cab	No	6.5 Box	4.2L V6	3660	3550	6000		67810	2,10	500	---	---	---	---	---	---	---	---	---	n/a	---	---	---
F150	4x4	Reg Cab	No	6.5 Box	4.6L V8	3680	3550	6250		67810	2,10	700	---	---	---	---	---	---	---	---	---	n/a	---	---	---
F150	4x4	Reg Cab	No	8.0 Box	5.4L V8	4150	4800	7700		67810	2,10	400	450	400	450	450	---	---	---	---	---	n/a	---	---	---
F150	4x4	Super Cab	No	6.5 Box	5.4L V8	4150	4800	7700		67810	2,10	350	400	400	400	400	---	---	---	---	---	n/a	---	---	---
F250 SUPER DUTY	4x4	Reg Cab	No	8.0 Box	5.4L V8	5200	6084	8800	2B use 8439 or HB5 use 8436	67982	2	450	450	450	500	450	550	550	600	600	n/a	---	---	---	
F250 SUPER DUTY	4x4	Reg Cab	No	8.0 Box	5.4L V8	4800	6084	8800		67982	2	450	450	450	500	450	550	550	600	600	n/a	---	---	---	
F250 SUPER DUTY	4x4	Reg Cab	No	8.0 Box	5.4L V8	4400	6084	8800		67982	2	800	---	950	---	1000	---	---	---	---	---	n/a	---	---	---
F250 SUPER DUTY	4x4	Reg Cab	No	8.0 Box	6.8L V10	5200	6084	8800		67982	2	500	550	500	550	500	600	650	650	650	n/a	---	---	---	
F250 SUPER DUTY	4x4	Reg Cab	No	8.0 Box	6.8L V10	4800	6084	8800		67982	2	500	550	500	550	500	600	650	750	850	n/a	---	---	---	
F250 SUPER DUTY	4x4	Reg Cab	No	8.0 Box	7.3L D	5200	6084	8800		67982	2	650	700	650	700	700	800	800	850	950	n/a	---	---	---	
F250 SUPER DUTY	4x4	Super Cab	No	7.0 Box	5.4L V8	5200	6084	8800		67982	2	450	500	450	500	450	550	600	600	600	n/a	---	---	---	
F250 SUPER DUTY	4x4	Super Cab	No	7.0 Box	5.4L V8	4800	6084	8800		67982	2	450	500	450	500	450	550	550	600	600	n/a	---	---	---	
F250 SUPER DUTY	4x4	Super Cab	No	7.0 Box	6.8L V10	5200	6084	8800		67982	2	500	550	500	550	550	650	650	650	650	n/a	---	---	---	
F250 SUPER DUTY	4x4	Super Cab	No	7.0 Box	6.8L V10	4800	6084	8800		67982	2	500	550	500	550	550	700	800	900	1000	n/a	---	---	---	
F250 SUPER DUTY	4x4	Super Cab	No	7.0 Box	7.3L D	5200	6084	8800		67982	2	650	700	700	700	700	950	---	---	---	n/a	---	---	---	
F250 SUPER DUTY	4x4	Super Cab	No	8.0 Box	5.4L V8	5200	6084	8800		67982	2	400	450	400	450	450	500	550	550	550	n/a	---	---	---	
F250 SUPER DUTY	4x4	Super Cab	No	8.0 Box	5.4L V8	4800	6084	8800		67982	2	400	450	400	450	450	550	650	750	850	n/a	---	---	---	
F250 SUPER DUTY	4x4	Super Cab	No	8.0 Box	6.8L V10	5200	6084	8800		67982	2	450	500	500	500	500	600	600	600	650	n/a	---	---	---	
F250 SUPER DUTY	4x4	Super Cab	No	8.0 Box	6.8L V10	4800	6084	8800		67982	2	450	700	550	750	650	---	---	---	---	n/a	---	---	---	
F250 SUPER DUTY	4x4	Super Cab	No	8.0 Box	7.3L D	5200	6084	8800		67982	2	650	900	750	950	850	---	---	---	---	n/a	---	---	---	
F250 SUPER DUTY	4x4	Crew Cab	No	7.0 Box	5.4L V8	5200	6084	8800		67982	2	350	400	350	400	400	500	500	500	500	n/a	---	---	---	
F250 SUPER DUTY	4x4	Crew Cab	No	7.0 Box	5.4L V8	4800	6084	8800		67982	2	350	400	350	400	400	700	850	950	---	n/a	---	---	---	
F250 SUPER DUTY	4x4	Crew Cab	No	7.0 Box	6.8L V10	5200	6084	8800		67982	2	400	450	450	450	450	550	550	550	600	n/a	---	---	---	
F250 SUPER DUTY	4x4	Crew Cab	No	7.0 Box	6.8L V10	4800	6084	8800		67982	2	600	850	700	900	800	---	---	---	---	n/a	---	---	---	
F250 SUPER DUTY	4x4	Crew Cab	No	7.0 Box	7.3L D	5200	6084	8800		67982	2	750	1000	850	---	950	---	---	---	---	n/a	---	---	---	
F250 SUPER DUTY	4x4	Crew Cab	No	8.0 Box	5.4L V8	5200	6084	8800		67982	2	350	400	400	---	400	500	500	500	550	n/a	---	---	---	
F250 SUPER DUTY	4x4	Crew Cab	No	8.0 Box	5.4L V8	4800	6084	8800		67982	2	400	650	500	700	600	---	---	---	---	n/a	---	---	---	
F250 SUPER DUTY	4x4	Crew Cab	No	8.0 Box	6.8L V10	5200	6084	8800		67982	2	450	450	450	450	450	550	550	550	600	n/a	---	---	---	
F250 SUPER DUTY	4x4	All	No	Chassis	All	All	All	8501		67982	2	?	?	?	?	?	?	?	?	?	n/a	---	---	---	

- Notes:**
1. Ballast amounts are based on a "Representative Vehicle," defined in the vehicle selection guide instructions, and must be modified for all other configurations for axle and GVWR compliance.
 2. Recommended snowplow prep package whenever available.
 10. May require bumper or air dam notching.

2001 Ford

Section 2 PRO-PLOW®, PRO PLUS® & Heavy Weight Blades

PRO-PLOW®					PRO PLUS®			
7'-6" STEEL	7'-6" POLY	8'-0" STEEL	8'-0" POLY	8'-6" STEEL	7'-6" STEEL	8'-0" STEEL	8'-6" STEEL	9'-0" STEEL
IUTP75	IUTPY75	IUTP80	IUTPY80	IUTP85	IUTPP75	IUTPP80	IUTPP85	IUTPP90
60381	62400	60390	62450	60308	64750	66980	66974	66901
67950					66490			
67951-2					64588			
64588					64999			
28800					28800			
56369					56369			
56462					56462			

Heavy Weight	
9'-0" STEEL	10'-0" STEEL
IUHW90	IUHW10
62301	62302
62298-1	
62299-1	
64400	
28800	
56369	
56462	

Model	Body Style	DRW	Box Option	Engine Type	Min FAWR	Min RAWR	Min GVWR	Harness Kit	UltraMount® system		Ballast Guidelines, lbs (1)								UniMount® system		Ballast Guidelines, lbs (1)		
									Mount Kit	Notes	1	2	3	4	5	6	7	8	9	10	11	12	13
F350 SUPER DUTY	4x4	Reg Cab	No	8.0 Box	5.4L V8	5200	6830	9900	67982	2	450	450	450	500	450	550	550	600	600	n/a	---	---	---
F350 SUPER DUTY	4x4	Reg Cab	No	8.0 Box	5.4L V8	4800	6830	9900	67982	2	400	450	450	450	450	550	550	600	600	n/a	---	---	---
F350 SUPER DUTY	4x4	Reg Cab	No	8.0 Box	5.4L V8	4400	6830	9900	67982	2	800	---	900	---	1000	---	---	---	---	n/a	---	---	---
F350 SUPER DUTY	4x4	Reg Cab	No	8.0 Box	6.8L V10	5200	6830	9900	67982	2	500	550	500	550	600	650	650	650	650	n/a	---	---	---
F350 SUPER DUTY	4x4	Reg Cab	No	8.0 Box	6.8L V10	4800	6830	9900	67982	2	500	550	500	550	500	600	650	700	800	n/a	---	---	---
F350 SUPER DUTY	4x4	Reg Cab	No	8.0 Box	7.3L D	5200	6830	9900	67982	2	650	700	650	700	700	800	800	800	900	n/a	---	---	---
F350 SUPER DUTY	4x4	Reg Cab	Yes	8.0 Box	5.4L V8	5200	8250	11200	67982	2	---	---	---	---	250	---	---	400	400	n/a	---	---	---
F350 SUPER DUTY	4x4	Reg Cab	Yes	8.0 Box	6.8L V10	5200	8250	11200	67982	2	---	---	---	---	300	---	---	400	400	n/a	---	---	---
F350 SUPER DUTY	4x4	Reg Cab	Yes	8.0 Box	7.3L D	5200	8250	11200	67982	2	---	---	---	---	450	---	---	950	---	n/a	---	---	---
F350 SUPER DUTY	4x4	Super Cab	No	7.0 Box	5.4L V8	5200	6830	9900	67982	2	450	500	450	500	450	550	600	600	600	n/a	---	---	---
F350 SUPER DUTY	4x4	Super Cab	No	7.0 Box	5.4L V8	4400	6830	9900	67982	2	1000	---	---	---	---	---	---	---	---	n/a	---	---	---
F350 SUPER DUTY	4x4	Super Cab	No	7.0 Box	6.8L V10	5200	6830	9900	67982	2	500	550	500	550	550	650	650	650	650	n/a	---	---	---
F350 SUPER DUTY	4x4	Super Cab	No	7.0 Box	7.3L D	5200	6830	9900	67982	2	650	700	700	700	700	900	1000	---	---	n/a	---	---	---
F350 SUPER DUTY	4x4	Super Cab	No	8.0 Box	5.4L V8	5200	6830	9900	67982	2	400	450	400	450	450	500	550	550	550	n/a	---	---	---
F350 SUPER DUTY	4x4	Super Cab	No	8.0 Box	5.4L V8	4800	6830	9900	67982	2	400	450	400	450	450	500	500	750	850	n/a	---	---	---
F350 SUPER DUTY	4x4	Super Cab	No	8.0 Box	6.8L V10	5200	6830	9900	67982	2	450	500	500	500	600	600	600	650	650	n/a	---	---	---
F350 SUPER DUTY	4x4	Super Cab	No	8.0 Box	6.8L V10	4800	6830	9900	67982	2	450	650	500	700	600	---	---	---	---	n/a	---	---	---
F350 SUPER DUTY	4x4	Super Cab	No	8.0 Box	7.3L D	5200	6830	9900	67982	2	600	750	650	800	700	---	---	---	---	n/a	---	---	---
F350 SUPER DUTY	4x4	Super Cab	Yes	8.0 Box	5.4L V8	5200	8250	11200	67982	2	---	---	---	---	300	---	---	400	450	n/a	---	---	---
F350 SUPER DUTY	4x4	Super Cab	Yes	8.0 Box	5.4L V8	4800	8250	11200	67982	2	---	---	---	---	300	---	---	900	1000	n/a	---	---	---
F350 SUPER DUTY	4x4	Super Cab	Yes	8.0 Box	6.8L V10	5200	8250	11200	67982	2	---	---	---	---	300	---	---	450	450	n/a	---	---	---
F350 SUPER DUTY	4x4	Super Cab	Yes	8.0 Box	6.8L V10	4800	8250	11200	67982	2	---	---	---	---	800	---	---	---	---	n/a	---	---	---
F350 SUPER DUTY	4x4	Super Cab	Yes	8.0 Box	7.3L D	5200	8250	11200	67982	2	---	---	---	---	900	---	---	---	---	n/a	---	---	---
F350 SUPER DUTY	4x4	Crew Cab	No	7.0 Box	6.8L V10	5200	6830	9900	67982	2	400	450	450	450	450	550	550	550	600	n/a	---	---	---
F350 SUPER DUTY	4x4	Crew Cab	No	7.0 Box	7.3L D	5200	6830	9900	67982	2	750	---	900	---	1000	---	---	---	---	n/a	---	---	---
F350 SUPER DUTY	4x4	Crew Cab	No	8.0 Box	5.4L V8	5200	6830	9900	67982	2	350	400	400	400	500	500	500	550	550	n/a	---	---	---
F350 SUPER DUTY	4x4	Crew Cab	No	8.0 Box	5.4L V8	4800	6830	9900	67982	2	350	650	450	700	600	---	---	---	---	n/a	---	---	---
F350 SUPER DUTY	4x4	Crew Cab	No	8.0 Box	6.8L V10	5200	6830	9900	67982	2	450	450	450	450	450	550	550	550	600	n/a	---	---	---
F350 SUPER DUTY	4x4	Crew Cab	Yes	7.0 Box	6.8L V10	5200	8250	11200	67982	2	---	---	---	---	300	---	---	450	450	n/a	---	---	---
F350 SUPER DUTY	4x4	Crew Cab	Yes	8.0 Box	6.8L V10	5200	8250	11200	67982	2	---	---	---	---	250	---	---	650	750	n/a	---	---	---
F350 SUPER DUTY	4x4	All	No	Chassis	All	All	All	8501	67982	2	?	?	?	?	?	?	?	?	?	n/a	---	---	---
F350 SUPER DUTY	4x4	All	Yes	Chassis	All	All	All	8501	67982	2	---	---	---	---	?	---	---	?	?	n/a	---	---	---
F350 SUPER DUTY	4x2	Super Cab	Yes	8.0 Box	5.4L V8	4250	8250	11200	33259	2,10,44	---	---	---	1000	---	---	---	---	---	n/a	---	---	---
F350 SUPER DUTY	4x2	Super Cab	Yes	8.0 Box	7.3L D	4850	8250	11200	33259	2,10,44	---	---	---	850	---	---	---	---	---	n/a	---	---	---
F350 SUPER DUTY	4x2	Crew Cab	Yes	8.0 Box	6.8L V10	4550	8250	11200	33259	2,10,44	---	---	---	---	1000	---	---	---	---	n/a	---	---	---

Notes:
 1. Ballast amounts are based on a "Representative Vehicle," defined in the vehicle selection guide instructions, and must be modified for all other configurations for axle and GVWR compliance.
 2. Recommended snowplow prep package whenever available.

10. May require bumper or air dam notching.
 44. Minimum height required from ground to foremost point on frame bottom is 22.5".

2001 Ford

Section 2

PRO-PLOW®, PRO PLUS® & Heavy Weight Blades

UltraMount								
PRO-PLOW®					PRO PLUS®			
7'-6" STEEL	7'-6" POLY	8'-0" STEEL	8'-0" POLY	8'-6" STEEL	7'-6" STEEL	8'-0" STEEL	8'-6" STEEL	9'-0" STEEL
IUTP75	IUTPY75	IUTP80	IUTPY80	IUTP85	IUTPP75	IUTPP80	IUTPP85	IUTPP90
60381	62400	60390	62450	60308	64750	66980	66974	66901
67950				66490				
64588					64999			
Light Kit				28800				
Choose a Joystick Control or Hand-Held Control				56369				
				56462				

UniMount	
Heavy Weight	
9'-0" STEEL	10'-0" STEEL
IUHW90	IUHW10
62301	62302
62298-1	
62299-1	
64400	
28800	
56369	
56462	

Model	Body Style	DRW	Box Option	Engine Type	Min F G A W R	Min R G A W R	Min G V W R	Harness Kit	UltraMount® system		Ballast Guidelines, lbs (1)								UniMount® system		Ballast Guidelines, lbs (1)				
									Mount Kit	Notes	1	2	3	4	5	6	7	8	9	10	11	12	Mount Kit	Notes	1
F450 SUPER DUTY	4x4	All	Yes	Chassis	All	All	8501	2B use 8439 or HB5 use 8436	67982	2	---	---	---	---	---	---	---	---	?	?	62275	---	?	?	
F450 SUPER DUTY	4x2	All	Yes	Chassis	All	All	10001		67982	---	---	---	---	---	---	---	---	---	---	?	?	62275	---	?	?
F550 SUPER DUTY	4x4	All	Yes	Chassis	All	All	8501		67982	2	---	---	---	---	---	---	---	---	---	?	?	62275	---	?	?
F550 SUPER DUTY	4x2	All	Yes	Chassis	All	All	10001	2B1 use 8439 & 26640	67982	---	---	---	---	---	---	---	---	---	---	?	?	62275	---	?	?
F650	4x2	All	Yes	Chassis	All	All	10001		n/a	---	---	---	---	---	---	---	---	---	---	---	---	62275	---	?	?
F650 (Low Pro)	4x2	All	Yes	Chassis	All	All	10001	n/a	---	---	---	---	---	---	---	---	---	---	---	---	62275	---	?	?	

- Notes:**
- Ballast amounts are based on a "Representative Vehicle," defined in the vehicle selection guide instructions, and must be modified for all other configurations for axle and GVWR compliance.
 - Recommended snowplow prep package whenever available.

2001 Ford

Section 3 MVP® & MVP PLUS™ Blades

MVP®	MVP PLUS™					
8'-6" STEEL	7'-6" STEEL	7'-6" POLY	8'-6" STEEL	8'-6" POLY	9'-6" STEEL	9'-6" POLY
IUMV85	IUTHVPP75	IUTHVPPY75	IUTHVPP85	IUTHVPPY85	IUTHVPP95	IUTHVPPY95
Blade Assembly	63819	44475	44575	44485	44585	44495
AQ&L Assembly Box 1	63910					
AQ&L Assembly Box 2	67951-2	44225				
Hydraulic Kit	64777					
Light Kit	28800					
Choose a Joystick Control or Hand-Held Control	96369					96700
	96462					96600

Model	4x4	Body Style	DRW	Box Option	Engine Type	Min F G A W R	Min R G A W R	Min G V W R	Harness Kit	UltraMount® system		2B use 8439 or HB5 use 8436	2B use 8439 or HB5 use 8436	2B use 8439 or HB5 use 8436	2B use 8439 or HB5 use 8436	2B use 8439 or HB5 use 8436	2B use 8439 or HB5 use 8436	2B use 8439 or HB5 use 8436
										Mount Kit	Notes							
F150	4x4	Reg Cab	No	8.0 Box	5.4L V8	4150	4800	7700	HB5 use 8436	67810	2,10	---	550	500	---	---	---	---
F150	4x4	Super Cab	No	6.5 Box	5.4L V8	4150	4800	7700	HB5 use 8436	67810	2,10	---	800	600	---	---	---	---
F250 SUPER DUTY	4x4	Reg Cab	No	8.0 Box	5.4L V8	5200	6084	8800	HB5 use 8436	67982	2	650	550	500	600	550	700	650
F250 SUPER DUTY	4x4	Reg Cab	No	8.0 Box	5.4L V8	4800	6084	8800	HB5 use 8436	67982	2	650	550	500	600	550	1000	750
F250 SUPER DUTY	4x4	Reg Cab	No	8.0 Box	6.8L V10	5200	6084	8800	HB5 use 8436	67982	2	700	600	550	650	600	750	700
F250 SUPER DUTY	4x4	Reg Cab	No	8.0 Box	6.8L V10	4800	6084	8800	HB5 use 8436	67982	2	---	600	550	850	700	---	---
F250 SUPER DUTY	4x4	Reg Cab	No	8.0 Box	7.3L D	5200	6084	8800	HB5 use 8436	67982	2	---	750	750	1000	800	---	---
F250 SUPER DUTY	4x4	Super Cab	No	7.0 Box	5.4L V8	5200	6084	8800	HB5 use 8436	67982	2	650	550	500	600	550	700	650
F250 SUPER DUTY	4x4	Super Cab	No	7.0 Box	5.4L V8	4800	6084	8800	HB5 use 8436	67982	2	700	550	500	600	550	---	900
F250 SUPER DUTY	4x4	Super Cab	No	7.0 Box	6.8L V10	5200	6084	8800	HB5 use 8436	67982	2	700	600	600	650	600	750	700
F250 SUPER DUTY	4x4	Super Cab	No	7.0 Box	6.8L V10	4800	6084	8800	2B use 8439 or HB5 use 8436	67982	2	---	750	600	---	850	---	---
F250 SUPER DUTY	4x4	Super Cab	No	7.0 Box	7.3L D	5200	6084	8800	2B use 8439 or HB5 use 8436	67982	2	---	950	800	---	---	---	---
F250 SUPER DUTY	4x4	Super Cab	No	8.0 Box	5.4L V8	5200	6084	8800	2B use 8439 or HB5 use 8436	67982	2	600	500	500	550	500	650	600
F250 SUPER DUTY	4x4	Super Cab	No	8.0 Box	5.4L V8	4800	6084	8800	2B use 8439 or HB5 use 8436	67982	2	---	600	500	900	700	---	---
F250 SUPER DUTY	4x4	Super Cab	No	8.0 Box	6.8L V10	5200	6084	8800	2B use 8439 or HB5 use 8436	67982	2	650	550	550	600	600	700	700
F250 SUPER DUTY	4x4	Crew Cab	No	7.0 Box	5.4L V8	5200	6084	8800	2B use 8439 or HB5 use 8436	67982	2	550	450	450	500	500	600	550
F250 SUPER DUTY	4x4	Crew Cab	No	7.0 Box	5.4L V8	4800	6084	8800	2B use 8439 or HB5 use 8436	67982	2	---	750	600	---	900	---	---
F250 SUPER DUTY	4x4	Crew Cab	No	7.0 Box	6.8L V10	5200	6084	8800	2B use 8439 or HB5 use 8436	67982	2	600	500	500	550	550	750	650
F250 SUPER DUTY	4x4	Crew Cab	No	8.0 Box	5.4L V8	5200	6084	8800	2B use 8439 or HB5 use 8436	67982	2	550	450	450	500	500	600	600
F250 SUPER DUTY	4x4	Crew Cab	No	8.0 Box	6.8L V10	5200	6084	8800	2B use 8439 or HB5 use 8436	67982	2	650	550	500	550	550	---	950
F250 SUPER DUTY	4x4	All	No	Chassis	All	All	All	8501	2B use 8439 or HB5 use 8436	67982	2	?	?	?	?	?	?	?

- Notes:**
- Ballast amounts are based on a "Representative Vehicle," defined in the vehicle selection guide instructions, and must be modified for all other configurations for axle and GVWR compliance.
 - Recommended snowplow prep package whenever available.
 - May require bumper or air dam notching.

2001 Ford

Section 3 MVP® & MVP PLUS™ Blades

MVP®	MVP PLUS™						
8'-6" STEEL	7'-6" STEEL	7'-6" POLY	8'-6" STEEL	8'-6" POLY	9'-6" STEEL	9'-6" POLY	
IUMVP85	IUTHVPP75	IUTHVPPY75	IUTHVPP85	IUTHVPPY85	IUTHVPP95	IUTHVPPY95	
Blade Assembly	63819	44475	44575	44485	44585	44495	
AQ&L Assembly Box 1	63910						
AQ&L Assembly Box 2	67951-2	44225					
Hydraulic Kit	64777						
Light Kit	28800						
Choose a Joystick Control or Hand-Held Control	96369					96700	
	96462						96600

Model	4x4	Body Style	DRW	Box Option	Engine Type	Min F G A W R	Min R G A W R	Min G V W R	Harness Kit	UltraMount® system		Ballast (lbs)						
										Mount Kit	Notes	67982	2	650	550	500	600	550
F350 SUPER DUTY	4x4	Reg Cab	No	8.0 Box	5.4L V8	5200	6830	9900		67982	2	650	550	500	600	550	700	650
F350 SUPER DUTY	4x4	Reg Cab	No	8.0 Box	5.4L V8	4800	6830	9900		67982	2	650	550	500	550	550	900	700
F350 SUPER DUTY	4x4	Reg Cab	No	8.0 Box	6.8L V10	5200	6830	9900		67982	2	700	600	550	650	600	750	700
F350 SUPER DUTY	4x4	Reg Cab	No	8.0 Box	6.8L V10	4800	6830	9900		67982	2	---	600	550	800	600	---	---
F350 SUPER DUTY	4x4	Reg Cab	No	8.0 Box	7.3L D	5200	6830	9900		67982	2	---	750	750	900	750	---	---
F350 SUPER DUTY	4x4	Reg Cab	Yes	8.0 Box	5.4L V8	5200	8250	11200		67982	2	450	---	---	400	350	500	450
F350 SUPER DUTY	4x4	Reg Cab	Yes	8.0 Box	6.8L V10	5200	8250	11200		67982	2	450	---	---	400	350	500	450
F350 SUPER DUTY	4x4	Reg Cab	Yes	8.0 Box	7.3L D	5200	8250	11200		67982	2	---	---	---	---	850	---	---
F350 SUPER DUTY	4x4	Super Cab	No	7.0 Box	5.4L V8	5200	6830	9900		67982	2	650	550	500	600	550	700	650
F350 SUPER DUTY	4x4	Super Cab	No	7.0 Box	6.8L V10	5200	6830	9900		67982	2	700	600	600	650	600	750	700
F350 SUPER DUTY	4x4	Super Cab	No	7.0 Box	7.3L D	5200	6830	9900		67982	2	---	950	800	---	---	---	---
F350 SUPER DUTY	4x4	Super Cab	No	8.0 Box	5.4L V8	5200	6830	9900		67982	2	600	500	500	550	500	650	600
F350 SUPER DUTY	4x4	Super Cab	No	8.0 Box	5.4L V8	4800	6830	9900		67982	2	---	550	500	900	700	---	---
F350 SUPER DUTY	4x4	Super Cab	No	8.0 Box	6.8L V10	5200	6830	9900		67982	2	650	550	550	600	600	700	700
F350 SUPER DUTY	4x4	Super Cab	Yes	8.0 Box	5.4L V8	5200	8250	11200		67982	2	450	---	---	400	400	500	500
F350 SUPER DUTY	4x4	Super Cab	Yes	8.0 Box	5.4L V8	4800	8250	11200		67982	2	---	---	---	---	850	---	---
F350 SUPER DUTY	4x4	Super Cab	Yes	8.0 Box	6.8L V10	5200	8250	11200		67982	2	500	---	---	450	400	700	500
F350 SUPER DUTY	4x4	Crew Cab	No	7.0 Box	6.8L V10	5200	6830	9900		67982	2	600	500	500	550	550	700	650
F350 SUPER DUTY	4x4	Crew Cab	No	8.0 Box	5.4L V8	5200	6830	9900		67982	2	550	450	450	500	500	600	600
F350 SUPER DUTY	4x4	Crew Cab	No	8.0 Box	6.8L V10	5200	6830	9900		67982	2	600	550	500	550	550	---	900
F350 SUPER DUTY	4x4	Crew Cab	Yes	7.0 Box	6.8L V10	5200	8250	11200		67982	2	500	---	---	400	400	850	600
F350 SUPER DUTY	4x4	Crew Cab	Yes	8.0 Box	6.8L V10	5200	8250	11200		67982	2	---	---	---	800	600	---	---
F350 SUPER DUTY	4x4	All	No	Chassis	All	All	All	8501		67982	2	?	?	?	?	?	?	?
F350 SUPER DUTY	4x4	All	Yes	Chassis	All	All	All	8501		67982	2	?	?	?	?	?	?	?
F450 SUPER DUTY	4x4	All	Yes	Chassis	All	All	All	8501		67982	2	?	?	?	?	?	?	?
F450 SUPER DUTY	4x2	All	Yes	Chassis	All	All	All	10001		67982	---	?	?	?	?	?	?	?
F550 SUPER DUTY	4x4	All	Yes	Chassis	All	All	All	8501		67982	2	?	?	?	?	?	?	?
F550 SUPER DUTY	4x2	All	Yes	Chassis	All	All	All	10001		67982	---	?	?	?	?	?	?	?

- Notes:**
- Ballast amounts are based on a "Representative Vehicle," defined in the vehicle selection guide instructions, and must be modified for all other configurations for axle and GVWR compliance.
 - Recommended snowplow prep package whenever available.

2001 International

Section 2

PRO-PLOW®, PRO PLUS® & Heavy Weight Blades

UltraMount														UniMount										
PRO-PLOW®							PRO PLUS®							Heavy Weight										
7'-6" STEEL	7'-6" POLY	8'-0" STEEL	8'-0" POLY	8'-6" STEEL	7'-6" STEEL	8'-0" STEEL	8'-6" STEEL	9'-0" STEEL	9'-0" STEEL	10'-0" STEEL														
IUTP75	IUTPY75	IUTP80	IUTPY80	IUTP85	IUTPP75	IUTPP80	IUTPP85	IUTPP90	IUHW90	IUHW10														
60381	62400	60390	62450	60308	64750	66980	66974	66901	62301	62302														
67950				66490				62298-1																
67951-2					64400		62299-1																	
64588				64999				64400																
Light Kit				28800				28800																
Choose a Joystick Control or Hand-Held Control				56369				56369																
				56462				56462																
Model	Body Style	DRW	Box Option	Engine Type	Min FGAWR	Min RGAWR	Min GVWR	Harness Kit	UltraMount® system		Ballast Guidelines, lbs (1)							UniMount® system		Ballast Guidelines, lbs (1)				
									Mount Kit	Notes											Mount Kit	Notes		
4000 SERIES	4x2	All	Yes	Chassis	All	All	10001	2B use 8439 & 26640 or HB5 use 8436 & 26640	n/a	---	---	---	---	---	---	---	---	---	---	---	62275	---	?	?

Notes:
 1. Ballast amounts are based on a "Representative Vehicle," defined in the vehicle selection guide instructions, and must be modified for all other configurations for axle and GVWR compliance.

2001 Jeep

Section 1 Suburbanite™ & MIDWEIGHT™ Blades

 Suburbanite™	
6'-8" POLY	7'-4" POLY
SUB68	SUB74
Plow Blade Assembly	27546 27548
AQ&L Assembly Box 1	27550
AQ&L Assembly Box 2	n/a
Hydraulic Kit	27516
Light Kit	64100
Choose a Joystick Control or Hand-Held Control	56369 56462

 UltraMount™	
MIDWEIGHT™	
7'-6" STEEL	7'-6" POLY
IUTH75	IUTHY75
64340	64330
64336	
67992	
64620	
28800	
56369	
56462	

Model	4x4	Body Style	DRW	Box Option	Engine Type	Min FGAWR	Min RGAWR	Min GVWR	Harness Kit	Personal Plow system		Ballast Guidelines, lbs (1)	UltraMount® system		Ballast Guidelines, lbs (1)	
										Mount Kit	Notes		Mount Kit	Notes		
WRANGLER	4x4	SU-2DR	No	---	2.5L I4	2500	2600	4360	2D use 8439	3723	8	0 0	n/a	---	---	---
WRANGLER	4x4	SU-2DR	No	---	2.5L I4	2200	2600	4360		3723	8	0 0	n/a	---	---	---

- Notes:**
- Ballast amounts are based on a "Representative Vehicle," defined in the vehicle selection guide instructions, and must be modified for all other configurations for axle and GVWR compliance.
 - These Snowplows Are For Personal/Homeowner Use Only.

2001 Mazda

Section 1 Suburbanite™ & MIDWEIGHT™ Blades

 Suburbanite™	
6'-8" POLY	7'-4" POLY
SUB68	SUB74
Plow	
Blade Assembly	
27546	27548
AQ&L Assembly Box 1	
27550	
AQ&L Assembly Box 2	
n/a	
Hydraulic Kit	
27516	
Light Kit	
64100	
Choose a Joystick Control or Hand-Held Control	
56369	
56462	

 UltraMount™	
MIDWEIGHT™	
7'-6" STEEL	7'-6" POLY
IUTH75	IUTHY75
64340	64330
64336	
67992	
64620	
28800	
56369	
56462	

Model	4x4	Body Style	DRW	Box Option	Engine Type	Min FGAWR	Min RGAWR	Min GVWR	Harness Kit	Personal Plow system		Ballast Guidelines, lbs (1)		UltraMount® system		Ballast Guidelines, lbs (1)	
										Mount Kit	Notes			Mount Kit	Notes		
B3000	4x4	Reg Cab	No	6.0 Box	3.0L V6	2800	2750	4700	HB5 use 8436	1203	8,10	100	150	n/a	---	---	---
B3000	4x4	Reg Cab	No	6.0 Box	3.0L V6	2800	2600	4700		1203	8,10	100	150	n/a	---	---	---
B3000	4x4	Reg Cab	No	6.0 Box	3.0L V6	2710	2750	4700		1203	8,10	100	150	n/a	---	---	---
B3000	4x4	Reg Cab	No	6.0 Box	3.0L V6	2710	2600	4700		1203	8,10	100	150	n/a	---	---	---
B3000	4x4	Reg Cab	No	6.0 Box	3.0L V6	2510	2750	4700		1203	8,10	350	450	n/a	---	---	---
B3000	4x4	Reg Cab	No	6.0 Box	3.0L V6	2510	2600	4700		1203	8,10	350	450	n/a	---	---	---
B3000	4x4	CabPlus	No	6.0 Box	3.0L V6	2800	2750	5060		1203	8,10	150	150	n/a	---	---	---
B3000	4x4	CabPlus	No	6.0 Box	3.0L V6	2800	2600	5060		1203	8,10	150	150	n/a	---	---	---
B3000	4x4	CabPlus	No	6.0 Box	3.0L V6	2710	2750	5060		1203	8,10	150	200	n/a	---	---	---
B3000	4x4	CabPlus	No	6.0 Box	3.0L V6	2710	2600	5060		1203	8,10	150	200	n/a	---	---	---
B4000	4x4	CabPlus4	No	6.0 Box	4.0L V6	2800	2750	5060		1203	8,10	100	150	n/a	---	---	---
B4000	4x4	CabPlus4	No	6.0 Box	4.0L V6	2800	2600	5060		1203	8,10	100	150	n/a	---	---	---
B4000	4x4	CabPlus4	No	6.0 Box	4.0L V6	2710	2750	5060		1203	8,10	450	550	n/a	---	---	---
B4000	4x4	CabPlus4	No	6.0 Box	4.0L V6	2710	2600	5060		1203	8,10	450	550	n/a	---	---	---

- Notes:**
- Ballast amounts are based on a "Representative Vehicle," defined in the vehicle selection guide instructions, and must be modified for all other configurations for axle and GVWR compliance.
 - These Snowplows Are For Personal/Homeowner Use Only.
 - May require bumper or air dam notching.

2001 Toyota

Section 1 Suburbanite™ & MIDWEIGHT™ Blades

 Suburbanite™	
6'-8" POLY	7'-4" POLY
SUB68	SUB74
Plow	
Blade Assembly	27546 27548
AQ&L Assembly Box 1	27550
AQ&L Assembly Box 2	n/a
Hydraulic Kit	27516
Light Kit	64100
Choose a Joystick Control or Hand-Held Control	56369 56462

 UltraMount™	
MIDWEIGHT™	
7'-6" STEEL	7'-6" POLY
IUTH75	IUTHY75
64340	64330
64336	
67992	
64620	
28800	
56369	
56462	

Model	4x4	Body Style	DRW	Box Option	Engine Type	Min F G A W R	Min R G A W R	Min G V W R	Harness Kit	Personal Plow system		Ballast Guidelines, lbs (1)	UltraMount® system		Ballast Guidelines, lbs (1)		
										Mount Kit	Notes		Mount Kit	Notes			
TACOMA	4x4	Reg Cab	No	8.0 Box	2.7L I4	2650	2800	5000	HB2 use 8439	2313	8	50	100	n/a	---	---	---
TACOMA	4x4	Ext Cab	No	6.5 Box	2.7L I4	2650	2800	5000		2313	8	50	100	n/a	---	---	---
TACOMA	4x4	Ext Cab	No	6.5 Box	3.4L V6	2650	2800	5100		2313	8	100	100	n/a	---	---	---
TUNDRA	4x4	Reg Cab	No	8.0 Box	4.7L V8	3160	3760	6200		2303	8	---	300	n/a	---	---	---
TUNDRA	4x4	Ext Cab	No	6.5 Box	4.7L V8	3160	3760	6050		2303	8	---	450	n/a	---	---	---

- Notes:**
- Ballast amounts are based on a "Representative Vehicle," defined in the vehicle selection guide instructions, and must be modified for all other configurations for axle and GVWR compliance.
 - These Snowplows Are For Personal/Homeowner Use Only.

HEADLAMP REFERENCE GUIDE

NOTE: The lamp type is usually embossed in the headlamp lens.

NOTE: Blue ground wires may be LT or DK BLU, w/ or w/o WHT stripe, depending on harness.

Headlamp Type	Bulb Type	Headlamp Type	Bulb Type
LF	H4703	2E1	H6545
UF	H4701	H13	9008
1A1	H4651	HB1	9004
2A1	H4652(GMC/Chevy)	HB2	9003
2A1	H4656 (Mitsubishi)	HB3	9005
2B1	H6054	HB4	9006
2D1	H6024	HB5	9007

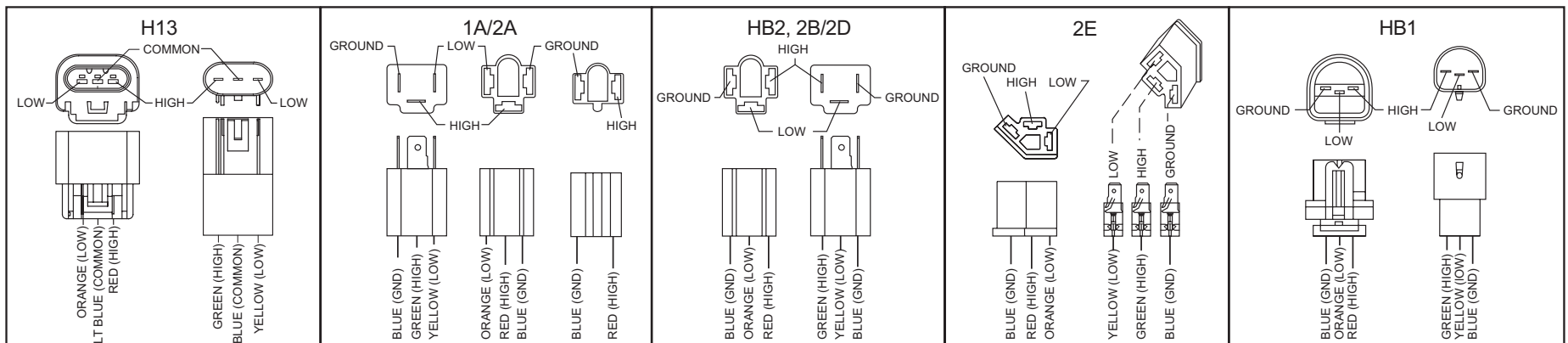
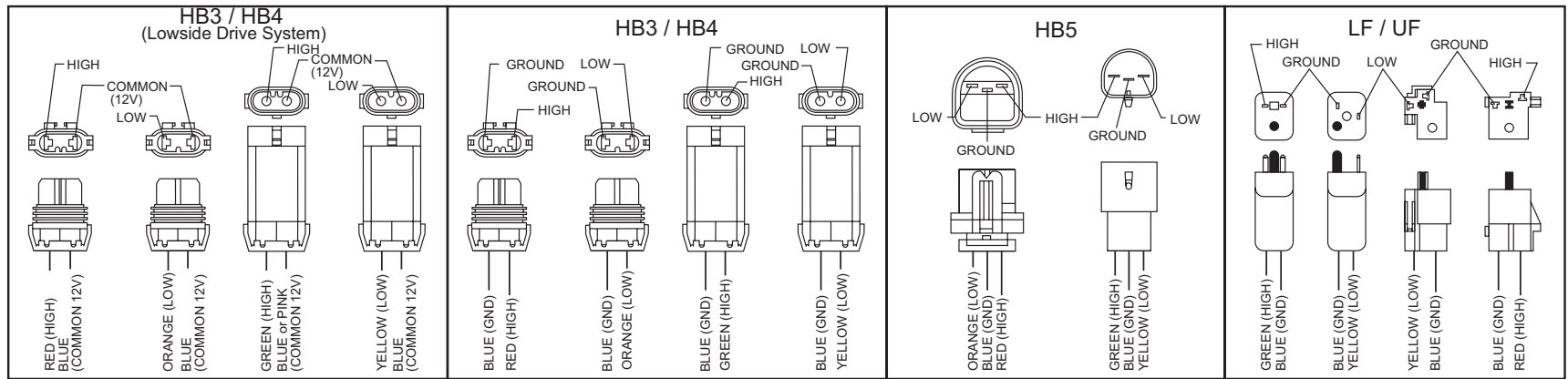

WEIGHT AND DIMENSIONAL CHARTS

Plows and Accessories Information										
Plows		Accessories – Part Number (Effective Added Weight in lb)								Var.
Size	Wt. (lb)	HD Poly Deflector	Rubber Deflector	Cutting Edge 1/2"	Back Drag Edge 1/4"	Wing Kit	Shoes	Curb Guard	Dolly Wheel	Z (in)
SUB68	239	—	—	—	—	—	27710 (5.7)	—	—	20.4
SUB74	257	—	—	—	—	—	27710 (5.7)	—	—	20.8
IUTM75	540	63700 (19.1)	62123 (29.6)	—	64758 (47.0)	—	64392 (21.1)	44404 (61.3)	—	20.4
IUTMY75	532	63700 (19.1)	62123 (29.6)	—	64758 (47.0)	—	64392 (21.1)	44404 (61.6)	—	20.3
IUTP75	682	63700 (19.2)	62123 (29.7)	49346 (25.8)	64758 (47.0)	—	—	44403 (63.8)	—	20.8
IUTPY75	719	—	—	49350 (24.8)	64758 (47.0)	—	—	44403 (58.4)	—	22.7
IUTP80	699	63670 (20.1)	62530 (33.8)	49347 (27.4)	66892 (60.6)	—	—	44403 (62.3)	—	21.3
IUTPY80	727	—	—	49351 (26.9)	66892 (60.6)	—	—	44403 (59.0)	—	22.5
IUTP85	715	63670 (21.1)	62220 (35.5)	49348 (28.8)	66999 (63.5)	—	—	44403 (61.7)	—	21.5
IUTPP75	789	63700 (12.4)	62123 (28.9)	—	64758 (59.7)	64410 (90)	—	44404 (41.2)	—	26.1
IUTPP80	805	63670 (13.3)	62530 (32.2)	—	66892 (63.2)	64410 (90)	—	44404 (40.7)	—	26.4
IUTPP85	821	63670 (14.2)	62220 (35.5)	—	66999 (66.2)	64410 (90)	—	44404 (40.3)	—	26.7
IUTPP90	837	63670 (15.0)	62220 (37.1)	—	66991 (69.2)	64410 (90)	—	44404 (39.8)	—	27.0
IMVP85	899	—	—	28409 (41.6)	—	—	—	—	—	24.0
IUTMVPP75	827	—	44278 (*)	44284 (*)	—	44276 (*)	44277 (*)	44404 (25.2)	—	18.4
IUTMVPPY75	799	—	44278 (*)	44284 (*)	—	44276 (*)	44277 (*)	44404 (25.5)	—	18.4
IUTMVPP85	880	—	44279 (*)	44285 (*)	—	44276 (*)	44277 (*)	44404 (24.0)	—	18.3
IUTMVPPY85	847	—	44279 (*)	44285 (*)	—	44276 (*)	44277 (*)	44404 (24.1)	—	18.3
IUTMVPP95	1006	—	44280 (*)	—	—	44276 (*)	44277 (*)	44404 (22.8)	—	18.8
IUTMVPPY95	964	—	44280 (*)	—	—	44276 (*)	44277 (*)	44404 (23.5)	—	18.8
IUHW90	1048	—	62220 (37.8)	—	—	—	—	44404 (33.7)	62430 (24.8)	33.0
IUHW10	1106	—	62124 (45.8)	—	—	—	—	44404 (33.1)	62430 (24.8)	33.6
—	—	UltraMount to UniMount Conversion Kit 27170 (94.0)								Varies

* This part number is currently not available for purchase, thus finalized weights have not been established. Once weights are established and product is available, finalized weights will be published.

NOTE: The addition of accessories to a snowplow or vehicle will require additional ballast above any amount published in this guide in order to maintain FMVSS compliance. Completed vehicle with additional accessories shall not exceed GVWR or GAWR.

NOTE: An abbreviation key is on page 2.

Mount Information							
Mount	Weight (lb)	X (in)	Y (in)	Mount	Weight (lb)	X (in)	Y (in)
Suburbanite™ Mounts							
1203	34.0	27.0	6.0	2313	30.0	27.0	5.0
1213-1	23.0	26.0	6.0	3713-1	20.0	26.0	5.0
1223	40.0	28.0	7.0	3723	35.0	21.4	5.0
1233	34.0	32.0	7.1	31303	43.0	27.9	4.8
1503	26.0	27.0	6.0	31543	20.0	28.5	7.1
1523	26.0	30.0	6.0	32323	36.0	30.0	7.3
1533-1	31.0	26.0	5.0	33903	45.0	31.0	7.8
2303	41.0	29.0	6.0	42021	37.0	29.0	8.0
UniMount® and UltraMount® Mounts							
1369	80.0	32.9	8.3	63760	40.0	30.0	8.0
1379	83.0	32.9	8.3	63883-2	47.0	37.0	6.9
3249	65.0	30.4	9.8	63900	87.0	29.6	12.5
3919	47.0	30.1	8.5	64110	115.0	38.0	10.0
33109	110.0	38.0	7.0	64500	33.0	32.5	8.9
33259	43.0	33.5	10.8	67810	44.0	35.1	8.7
33559	115.0	38.0	10.0	67865	41.0	31.3	7.6
33929	39.0	32.5	8.1	67960-1	34.0	29.1	7.6
30999	40.0	33.5	8	67980	51.0	35.0	8.5
62275	Varies			67981-2	54.0	32.4	11.4
63710-1	87.0	27.8	5.7	67982	69.0	30.4	9.0

NOTE: See next page for variable definitions.

DIMENSIONAL DIAGRAM

Variables:

X = Distance from center of front axle to receiver pin

Y = Distance from receiver pin to CG of mount.

Z = Distance from receiver pin to CG of snowplow.

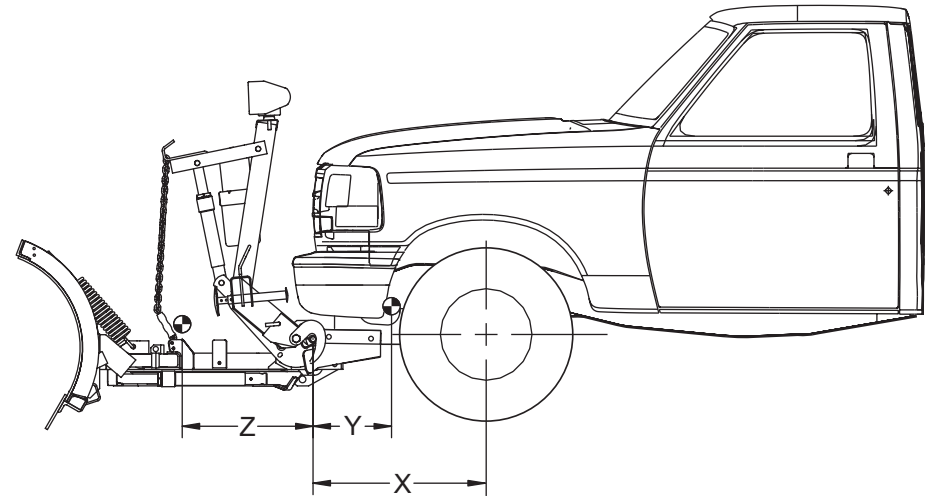

Example: Weight that one would use if they had an IUTP75 with the poly deflector and a 1/2" cutting edge.

The weight of the plow alone with no accessories would be 682 lb with its center of gravity 20.8 in from the coupling point. To add the weight of the accessories, look in the row with the IUTP75 blade to find the effective poly deflector weight of 19.2 lb and the effective cutting edge weight of 25.8 lb.

The total weight of the blade and accessories will be:

$$\begin{array}{r}
 682.0 \\
 19.2 \\
 + 25.8 \\
 \hline
 727.0
 \end{array}$$

with its center of gravity still at 20.8 in from the coupling point

ALWAYS comply with the vehicle manufacturer's stated gross vehicle and axle weight ratings (found on

the driver-side door jamb of the vehicle) and front and rear weight distribution ratio with the snowplow installed. In some cases, rear ballast may be required to achieve these requirements.

Available vehicle capacities for aftermarket equipment and components can be determined by using the above information along with information provided by the vehicle manufacturer's Body Builder Guides. Follow all requirements and recommendations as stated by vehicle manufacturer.

NOTE: An abbreviation key is on page 2.

VEHICLE AND PLOW APPLICATION INQUIRY SHEET



Western Products
7777 North 73rd Street
Milwaukee, WI 53223

Telephone (414) 354-2310
Fax (414) 354-6664

DISTRIBUTOR		TEL
		FAX

CUSTOMER		
VIN		DATE BUILT

SELECT MOUNT TYPE	<input type="checkbox"/> UniMount [®]	<input type="checkbox"/> UltraMount [®]	<input type="checkbox"/> Conversion Kit
	<input type="checkbox"/> Suburbanite [™]		

VEHICLE INFORMATION

YEAR			
MAKE			
MODEL			
DRIVE TRAIN	<input type="checkbox"/> 4x2 (over 10,000 lb. GVW only)	<input type="checkbox"/> 4x4	<input type="checkbox"/> ALL WHEEL <input style="width: 50px;" type="text"/> OTHER
DRW (Dual Rear Wheels)	<input type="checkbox"/> YES	<input type="checkbox"/> NO	
BODY STYLE	<input type="checkbox"/> REG CAB	<input type="checkbox"/> EXT CAB	<input style="width: 50px;" type="text"/> OTHER
BOX OPTION (S)	<input type="checkbox"/> DUMP BOX	<input type="checkbox"/> STAKE BED	<input style="width: 50px;" type="text"/> OTHER
ENGINE TYPE			
GFAWR			
GRAWR			
GVWR			

HORIZONTAL DISTANCE DESCRIPTION

L31	DRIVERS hip point; in MIDDLE position, to Centerline of FRONT axle	(in.)
L101	Between axles (Wheelbase)	(in.)
L104	Middle of FRONT bumper to centerline of FRONT axle	(in.)
	Middle of ballast location to centerline of REAR axle	(in.)

VEHICLE WEIGHT (TRUCK MUST BE WEIGHED COMPLETE AND EMPTY (-) OCCUPANTS, PLOW & MOUNT)

FRONT (lb.)	REAR (lb.)

FUEL TANKS (ONLY NEEDED IF WEIGHED VEHICLE NOT FULLY FUELED)

	LEVEL (see below)	CAPACITY (gal.)	LOCATION FROM AXLE TO CENTER OF TANK(in.)
FRONT OF AXLE			
REAR OF AXLE			

FUEL LEVEL (EMPTY = 0, HALF = 1/2, FULL = 1)

THIS FORM *MUST* BE COMPLETED IN ITS ENTIRETY. ANY FORMS CONTAINING INCOMPLETE INFORMATION *WILL NOT BE CONSIDERED*. PLEASE RETURN VIA FAX (414) 354-6664.

Western Products or the vehicle manufacturer may require or recommend optional equipment for snow removal.
See the WESTERN[®] Selection List for additional product information.

UltraMount® SYSTEM TO UniMount® SYSTEM CONVERSION KIT (PN 27170)

⚠ WARNING

Conversion kit use is limited to vehicles up to 19,500 lb GVWR.

⚠ WARNING

Do not exceed GVWR or GAWR, including blade and ballast. The rating label is found on the driver-side vehicle door cornerpost.

This easy to use UltraMount system to UniMount system conversion kit enables you to attach a UniMount plow to a vehicle equipped with an UltraMount mount.

Simply remove the receivers from your UltraMount system mount, and pin the conversion plate in place. This accessory is perfect for customers with multiple snowplows, providing their fleet with versatility while changing to the UltraMount system.

This new kit is also ideal for transferring an old UniMount plow to a new truck. As new trucks are released, we will develop only new UltraMount mounts for these plow applications. This will allow the customer to transfer an existing UniMount plow to the late model vehicle. In addition, when customers are ready to replace their old UniMount plow, the truck will already have the mount and wiring for an UltraMount plow.

TO QUALIFY THE VEHICLE AND DETERMINE BALLAST, YOU MUST FILL OUT THE VEHICLE AND PLOW APPLICATION INQUIRY SHEET.

NOTE: When ballast is required, it should be secured behind the rear wheels in a manner which prevents it from sliding during normal driving. Western Products offers an options ballast retainer kit (PN 62849) for this purpose.

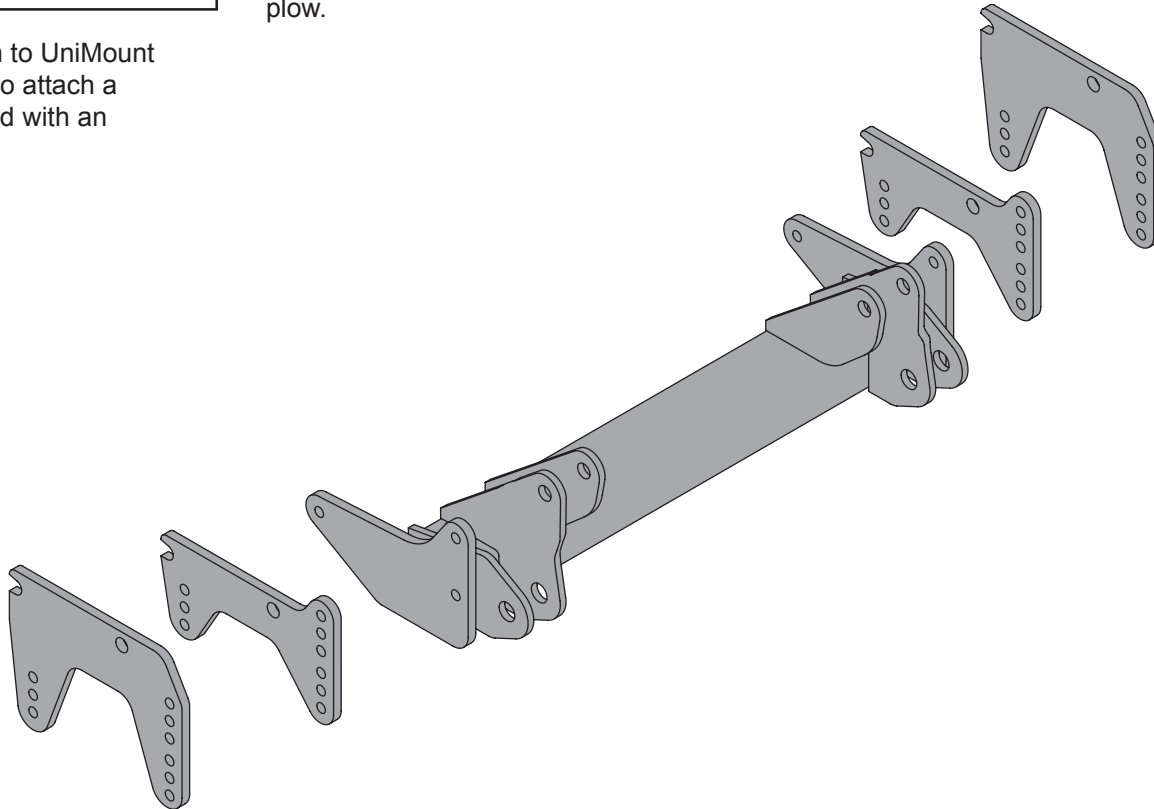

Notes:



WESTERN PRODUCTS
P.O. BOX 245038
MILWAUKEE, WI 53224-9538

 A DIVISION OF DOUGLAS DYNAMICS, L.L.C.

Western Products reserves the right under its product improvement policy to change construction or design details and furnish equipment when so altered without reference to illustrations or specifications used. Western Products or the vehicle manufacturer may require or recommend optional equipment for snow removal. Do not exceed vehicle ratings with a snowplow. Western Products offers a limited warranty for all snowplows and accessories. See separately printed page for this important information. The following are registered (®) or unregistered (™) trademarks of Douglas Dynamics, L.L.C.: MIDWEIGHT™, MVP®, MVP PLUS™, POLY PRO-PLOW®, PRO-PLOW®, PRO PLUS®, Suburbanite™, UltraMount®, UniMount®, WESTERN®.

Printed in U.S.A.