



1998

MODEL YEAR VEHICLES

SELECTION LIST

Isolation Module System Snowplows



Lit. No. 64302
June 1, 2006
Revision 06

This document supersedes all editions with an earlier date.

TABLE OF CONTENTS

About the <i>Selection List</i>	3	Toyota Attachment Kits	19
Selection Example	4	Headlamp Reference Guide	20
Chevy/GMC Attachment Kits	5	Weight and Dimensional Charts	21
Dodge Attachment Kits	9	Dimensional Diagram	22
Ford Attachment Kits	12	Ballast Inquiry Sheet	23
International Attachment Kits	17	UltraMount® System to UniMount® System	
Jeep Attachment Kits	18	Conversion Kit	24

ABBREVIATION KEY			
---	No Application	NTEA	National Truck Equipment Association
4WS	Four Wheel Steering	OEM	Original Equipment Manufacturer
4x2	Two Wheel Drive	OHC	Overhead Cam
4x4	Four Wheel Drive	PN	Part Number
A,Q&L	A-Frame, Quadrant & Lift Frame	RGAWR	Rear Gross Axle Weight Rating
AWD	All Wheel Drive	SL	Selection List
CG	Center of Gravity	SU-2DR	Two Door Sport/Utility Vehicle
Chassis	Chassis Cab or Cab Chassis	SU-4DR	Four Door Sport/Utility Vehicle
DIA	Diameter	SUB	Suburbanite™ Snowplow
DRW	Dual Rear Wheels	UHW	UniMount® Heavy Weight Snowplow
Ext Cab	Extended Cab Vehicle	UTM	UltraMount® MIDWEIGHT™ Snowplow
FFV	Flex Fuel Vehicle	UTMY	UltraMount MIDWEIGHT Poly Snowplow
FGAWR	Front Gross Axle Weight Rating	UTMVP	UltraMount MVP® Snowplow
FMVSS	Federal Motor Vehicle Safety Standards	UTMVPP	UltraMount MVP PLUS Snowplow
GVWR	Gross Vehicle Weight Rating	UTMVPPY	UltraMount Poly MVP PLUS Snowplow
HD	Heavy Duty	UTP	UltraMount PRO-PLOW® Snowplow
HO	High Output	UTPP	UltraMount PRO PLUS® Snowplow
HYD	Hydraulic	UTPY	UltraMount POLY PRO-PLOW Snowplow
MIN	Minimum	w/	With
MVP	MultiPosition V-Plow	w/o	Without
MVPP	MVP PLUS™ Snowplow		

⚠ WARNING

New untitled vehicle installation of a snowplow requires National Highway Traffic Safety Administration altered vehicle certification labeling. Installer to verify that selected snowplow and ballast, if required, do not exceed GVWR or GAWR rating label and complies with FMVSS.

⚠ WARNING

Do not exceed GVWR or GAWR, including blade and ballast. The rating label is found on the driver-side vehicle door cornerpost.

ABOUT THE SELECTION LIST

The *Selection List (SL)* is designed to help you determine the appropriate snowplow components for a particular snowplow vehicle application. The information published in this guide is based on Federal Motor Vehicle Safety Standards (FMVSS) and a "representative" snowplow vehicle as defined in this guide. The vehicle includes a combined weight of 300 lb for occupants in the front seat location.

This *SL* is for specific model year vehicles only and is listed on the front cover of this guide. This guide should be saved for future reference. New selection guides will be published for the upcoming model year and so on. The instructions on page 4 explain how to use the *Selection List*.

The "Representative Vehicle"

Knowing that today's snowplow vehicles come in a variety of sizes and configurations (such as wheel base, engine size, and handling packages), Western Products has defined a "representative vehicle" that contains the options most likely to appear on a typical snowplow application. The "representative vehicle" includes the following options:

- 4X4 Drivetrain (unless noted)
- Spare Tire & Wheel
- Automatic Transmission
- Rear Bumper
- Air Conditioning
- Full Fluids

NOTE: If the vehicle in question does not match a vehicle listing in the *Selection List*, or has options that differ from the "Representative Vehicle" as defined earlier, the ballast inquiry sheet must be filled out and submitted in order to determine plow availability and correct ballast amounts to maintain FMVSS compliance. Completed vehicle at no time shall exceed GVWR or GAWR.

Snowplow Product

Snowplows are considered motor vehicle equipment. The installer is ultimately responsible for determining and correctly labeling the vehicle with the addition of snowplow selection. No product selected and installed shall render inoperative the vehicle's safety compliance.

Product Changes

All information is as accurate as we can determine but is subject to revision with additional or more complete information. Western Products reserves the right under its product improvement policy to change construction or design details and furnish equipment when so altered without reference to illustrations or specifications used. Western Products or the vehicle manufacturer may require or recommend optional equipment for snow removal.

Ballast

When ballast is required it must be secured behind the rear wheels in a manner which prevents it from sliding during normal driving. Ballast shall not exceed 1000 lb.

Western Products offers an optional ballast retainer kit (62849) for this purpose.

HOW TO USE THE SELECTION LIST

Selection Example:

Acme Motors 15000 VX with UltraMount® System

- Go to the section for the appropriate manufacturer.
- Go to the subsection for the desired snowplow:
 - **Section 1:** Suburbanite™ & MIDWEIGHT™ snowplows
 - **Section 2:** PRO-PLOW®, PRO PLUS® & Heavy Weight snowplows
 - **Section 3:** MVP® & MVP PLUS™ snowplows
- Starting at the left-most column, find the **model** and appropriate configuration for the vehicle. In this case, 4X4, Regular Cab, 6.5 ft. box, 5.3L V8 engine, 3925 Min. FGAWR.

- Locate the **harness kit** part number for this vehicle: 27780. See Headlamp Reference Guide in the back of the Selection List for more information.
- Locate the **mount** for this vehicle: 1523 for Suburbanite™ system or 67960-1 for UltraMount® system. Refer to any footnotes concerning conditions or requirements. For this example the UltraMount system is selected and has five footnotes: 1, 2, 3, 4 and 6.
- Locate the acceptable **blades** at the top of the table. Only those blades with ballast weights listed are valid applications. Three short dashes (—) indicates an invalid application. A question mark (?) indicates a ballast inquiry sheet must be completed.

- For this example, there are two acceptable UltraMount blades. Choose the 7'-6" Steel MIDWEIGHT blade. This blade requires 350 lb of ballast.
- To order components for a complete snowplow package, read down from the top of the selected blade column for appropriate part numbers. Be sure to select *one* control, either joystick or hand-held. For this example, the part numbers would be:
 - 64340 (blade assembly)
 - 64336 (A, Q & L assembly Box 1)
 - 67992 (A, Q & L assembly Box 2)
 - 64620 (hydraulic kit)
 - 28800 (light kit)
 - 56369 or 56462 (control)
 - 27780 (harness kit, from Step 4)
 - 67960-1 (mount, from Step 5 – *must match blade*)

1998 Acme Motors

Section 1 Suburbanite™ & MIDWEIGHT™ blades

Model	Body Style	DRW	Box Option	Engine Type	Min FGAWR	Min RGAWR	Min GVWR	Harness Kit	Personal Plow system		Ballast Guidelines, lbs (1)	UltraMount® system		Ballast Guidelines, lbs (1)			
									Mount Kit	Notes		Mount Kit	Notes				
15000 RS	4x4	Reg Cab	No	6.5 Box	4.3L V6	3925	3750	6400	HB3/HB4 use	1523	3,6,8	---	100	67960-1	2,3,4,6	350	300
15000 TU	4x4	Reg Cab	No	6.5 Box	4.8L V8	3925	3750	6400		1523	3,6,8	---	150	67960-1	2,3,4,6	400	400
15000 VX	4x4	Reg Cab	No	6.5 Box	5.3L V8	3925	3750	6400		1523	3,6,8	---	100	67960-1	2,3,4,6	350	350

Suburbanite™		
6'-8" POLY	7'-4" POLY	
SUB68	SUB74	
Blade Assembly	27546	27548
AQ&L Assembly Box 1	27550	
AQ&L Assembly Box 2	n/a	
Hydraulic Kit	27516	
Light Kit	64100	
Choose a Joystick Control or Hand-Held Control	56369	
	56462	

UltraMount™		
MIDWEIGHT™		
7'-6" STEEL	7'-6" POLY	
IUTH75	IUTHY75	
Blade Assembly	64340	64330
AQ&L Assembly Box 1	64336	
AQ&L Assembly Box 2	67992	
Hydraulic Kit	64620	
Light Kit	28800	
Choose a Joystick Control or Hand-Held Control	56369	
	56462	

- Notes:**
- Ballast amounts are based on a "Representative Vehicle," defined in the vehicle selection guide instructions, and must be modified for all other configurations for axle and GVWR compliance.
 - Recommended snowplow prep package whenever available.
 - Requires bumper notching.
 - Recommended Z85 suspension.
 - All New Style Only (2nd # in model # is 5 not 0) example: K15903. Refer to label in glove box for model number.
 - These Snowplows Are For Personal/Homeowner Use Only.

1998 Chevy/GMC

Section 1 Suburbanite™ & MIDWEIGHT™ Blades

 Suburbanite™	
6'-8" POLY SUB68	7'-4" POLY SUB74
Plow Blade Assembly AQ&L Assembly Box 1 AQ&L Assembly Box 2 Hydraulic Kit Light Kit Choose a Joystick Control or Hand-Held Control	
27546	27548
27550	
n/a	
27516	
64100	
56369	
56462	

 UltraMount™	
MIDWEIGHT™	
7'-6" STEEL IUTH75	7'-6" POLY IUTHY75
64340	64330
64336	
67992	
64620	
28800	
56369	
56462	

Model	Body Style	DRW	Box Option	Engine Type	Min F G A W R	Min R G A W R	Min G V W R	Harness Kit	Personal Plow system		Ballast Guidelines, lbs (1)	UltraMount® system		Ballast Guidelines, lbs (1)			
									Mount Kit	Notes		Mount Kit	Notes				
BLAZER/JIMMY	4x4	SU-4DR	No	---	4.3L V6	2800	2900	5350	HB3/HB4 use 27480	1503	8,16	250	---	67865	5	---	---
BLAZER/JIMMY	4x4	SU-4DR	No	---	4.3L V6	2800	2700	5350	27480	1503	8,16	150	250	67865	5	---	---
TAHOE/YUKON 1500	4x4	SU-2DR	No	---	5.7L V8	3925	3750	6250	2B use 8439 or HB3/HB4 use 8438	n/a	---	---	---	67865	5,18	50	50
SUBURBAN K1500	4x4	SU-4DR	No	---	5.7L V8	3925	4800	8050		n/a	---	---	---	67865	5,18	0	0
SUBURBAN K1500	4x4	SU-4DR	No	---	5.7L V8	3925	4000	7300		n/a	---	---	---	67865	5,18	0	0
SUBURBAN K2500	4x4	SU-4DR	No	---	5.7L V8	4250	6000	8600		n/a	---	---	---	67865	5,18	0	0
SUBURBAN K2500	4x4	SU-4DR	No	---	6.5L D	4250	6000	8600		n/a	---	---	---	67865	5,18	200	150
SUBURBAN K2500	4x4	SU-4DR	No	---	7.4L V8	4250	6000	8600		n/a	---	---	---	67865	5,18	0	0
S-10/SONOMA	4x4	Reg Cab	No	6.5 Box	4.3L V6	2700	2700	5150		HB3/HB4 use 27480	1503	8,16	300	400	n/a	---	---
S-10/SONOMA	4x4	Reg Cab	No	6.5 Box	4.3L V6	2700	2300	4650	1503		8,16	300	400	n/a	---	---	---
S-10/SONOMA	4x4	Reg Cab	No	7.0 Box	4.3L V6	2700	2700	5150	1503		8,16	500	600	n/a	---	---	---
K1500 CLASSIC	4x4	Reg Cab	No	6.5 Box	4.3L V6	3925	3750	6100	2B use 8439 or HB3/HB4 use 8438	n/a	---	---	---	67865	5,18	400	350
K1500 CLASSIC	4x4	Reg Cab	No	6.5 Box	4.3L V6	3600	3750	6100		n/a	---	---	---	67865	5,18	400	350
K1500 CLASSIC	4x4	Reg Cab	No	6.5 Box	5.0L V8	3925	3750	6100		n/a	---	---	---	67865	5,18	400	400
K1500 CLASSIC	4x4	Reg Cab	No	6.5 Box	5.0L V8	3600	3750	6100		n/a	---	---	---	67865	5,18	650	600
K1500 CLASSIC	4x4	Reg Cab	No	6.5 Box	5.7L V8	3925	3750	6100		n/a	---	---	---	67865	5,18	450	400
K1500 CLASSIC	4x4	Reg Cab	No	8.0 Box	4.3L V6	3925	3750	6100		n/a	---	---	---	67865	5,18	400	400
K1500 CLASSIC	4x4	Reg Cab	No	8.0 Box	4.3L V6	3600	3750	6100		n/a	---	---	---	67865	5,18	---	650
K1500 CLASSIC	4x4	Reg Cab	No	8.0 Box	5.0L V8	3925	3750	6100		n/a	---	---	---	67865	5,18	450	450
K1500 CLASSIC	4x4	Reg Cab	No	8.0 Box	5.7L V8	3925	3750	6100		n/a	---	---	---	67865	5,18	450	450
K1500 CLASSIC	4x4	Ext Cab	No	6.5 Box	4.3L V6	3925	3750	6800		n/a	---	---	---	67865	5,18	250	250
K1500 CLASSIC	4x4	Ext Cab	No	6.5 Box	4.3L V6	3925	3750	6600		n/a	---	---	---	67865	5,18	250	250
K1500 CLASSIC	4x4	Ext Cab	No	6.5 Box	4.3L V6	3925	3750	6200		n/a	---	---	---	67865	5,18	350	350
K1500 CLASSIC	4x4	Ext Cab	No	6.5 Box	4.3L V6	3600	3750	6800		n/a	---	---	---	67865	5,18	900	850
K1500 CLASSIC	4x4	Ext Cab	No	6.5 Box	4.3L V6	3600	3750	6600		n/a	---	---	---	67865	5,18	900	850
K1500 CLASSIC	4x4	Ext Cab	No	6.5 Box	5.0L V8	3925	3750	6800		n/a	---	---	---	67865	5,18	300	300
K1500 CLASSIC	4x4	Ext Cab	No	6.5 Box	5.0L V8	3925	3750	6600		n/a	---	---	---	67865	5,18	300	300
K1500 CLASSIC	4x4	Ext Cab	No	6.5 Box	5.0L V8	3925	3750	6200		n/a	---	---	---	67865	5,18	400	400
K1500 CLASSIC	4x4	Ext Cab	No	6.5 Box	5.7L V8	3925	3750	6800		n/a	---	---	---	67865	5,18	300	300
K1500 CLASSIC	4x4	Ext Cab	No	6.5 Box	5.7L V8	3925	3750	6600		n/a	---	---	---	67865	5,18	300	300
K1500 CLASSIC	4x4	Ext Cab	No	6.5 Box	5.7L V8	3925	3750	6200		n/a	---	---	---	67865	5,18	400	400
K1500 CLASSIC	4x4	Ext Cab	No	8.0 Box	5.0L V8	3925	3750	6800		n/a	---	---	---	67865	5,18	350	300
K1500 CLASSIC	4x4	Ext Cab	No	8.0 Box	5.0L V8	3925	3750	6600		n/a	---	---	---	67865	5,18	350	300
K1500 CLASSIC	4x4	Ext Cab	No	8.0 Box	5.7L V8	3925	3750	6800		n/a	---	---	---	67865	5,18	300	250
K1500 CLASSIC	4x4	Ext Cab	No	8.0 Box	5.7L V8	3925	3750	6600		n/a	---	---	---	67865	5,18	300	250

- Notes:**
- Ballast amounts are based on a "Representative Vehicle," defined in the vehicle selection guide instructions, and must be modified for all other configurations for axle and GVWR compliance.
 - Classic Style Only (2nd # in model # is 0 not 5) example: K10903. Refer to label in glove box for model number.

- These Snowplows Are For Personal/Homeowner Use Only.
- Not intended for use with High Rider or ZR2 style trucks.
- Recommended F60 suspension or snowplow prep package.

1998 Chevy/GMC

Section 1 Suburbanite™ & MIDWEIGHT™ Blades

 Suburbanite™	
6'-8" POLY	7'-4" POLY
SUB68	SUB74
Blade Assembly	27546 27548
AQ&L Assembly Box 1	27550
AQ&L Assembly Box 2	n/a
Hydraulic Kit	27516
Light Kit	64100
Choose a Joystick Control	56369
or Hand-Held Control	56462

 UltraMount™	
MIDWEIGHT™	
7'-6" STEEL	7'-6" POLY
IUTH75	IUTHY75
64340	64330
64336	
67992	
64620	
28800	
56369	
56462	

Model	Body Style	DRW	Box Option	Engine Type	Min F G A W R	Min R G A W R	Min G V W R	Harness Kit	Personal Plow system		Ballast Guidelines, lbs (1)	UltraMount® system		Ballast Guidelines, lbs (1)			
									Mount Kit	Notes		Mount Kit	Notes				
K1500 W/T CLASSIC	4x4	Reg Cab	No	6.5 Box	4.3L V6	3925	3750	6100	n/a	---	---	---	67865	5,18	450	450	
K1500 W/T CLASSIC	4x4	Reg Cab	No	6.5 Box	4.3L V6	3600	3750	6100	n/a	---	---	---	67865	5,18	450	450	
K1500 W/T CLASSIC	4x4	Reg Cab	No	8.0 Box	4.3L V6	3925	3750	6100	n/a	---	---	---	67865	5,18	500	450	
K1500 W/T CLASSIC	4x4	Reg Cab	No	8.0 Box	4.3L V6	3600	3750	6100	n/a	---	---	---	67865	5,18	---	700	
K2500 CLASSIC	4x4	Ext Cab	No	6.5 Box	5.7L V8	4500	6000	8600	n/a	---	---	---	67865	5,18	300	300	
K2500 CLASSIC	4x4	Ext Cab	No	6.5 Box	5.7L V8	4250	6000	8600	n/a	---	---	---	67865	5,18	300	300	
K2500 CLASSIC	4x4	Ext Cab	No	6.5 Box	6.5L D	4500	6000	8600	n/a	---	---	---	67865	5,18	400	400	
K2500 CLASSIC	4x4	Ext Cab	No	6.5 Box	7.4L V8	4500	6000	8600	n/a	---	---	---	67865	5,18	350	350	
K2500 CLASSIC	4x4	Ext Cab	No	6.5 Box	7.4L V8	4250	6000	8600	n/a	---	---	---	67865	5,18	750	700	
K2500 CLASSIC	4x4	All	No	Chassis	All	All	All	8501	n/a	---	---	---	67865	5,18	?	?	
K2500HD CLASSIC	4x4	Reg Cab	No	8.0 Box	5.7L V8	4500	6000	8600	2B use 8439 or HB3/HB4 use 8438	n/a	---	---	---	67865	5,18	350	350
K2500HD CLASSIC	4x4	Reg Cab	No	8.0 Box	5.7L V8	4250	6000	8600		n/a	---	---	---	67865	5,18	350	350
K2500HD CLASSIC	4x4	Reg Cab	No	8.0 Box	6.5L D	4500	6000	8600		n/a	---	---	---	67865	5,18	350	350
K2500HD CLASSIC	4x4	Reg Cab	No	8.0 Box	6.5L D	4250	6000	8600		n/a	---	---	---	67865	5,18	600	550
K2500HD CLASSIC	4x4	Reg Cab	No	8.0 Box	7.4L V8	4500	6000	8600		n/a	---	---	---	67865	5,18	400	400
K2500HD CLASSIC	4x4	Reg Cab	No	8.0 Box	7.4L V8	4250	6000	8600		n/a	---	---	---	67865	5,18	650	600
K2500HD CLASSIC	4x4	Ext Cab	No	8.0 Box	5.7L V8	4500	6000	8600		n/a	---	---	---	67865	5,18	250	250
K2500HD CLASSIC	4x4	Ext Cab	No	8.0 Box	5.7L V8	4250	6000	8600		n/a	---	---	---	67865	5,18	250	250
K2500HD CLASSIC	4x4	Ext Cab	No	8.0 Box	6.5L D	4500	6000	8600		n/a	---	---	---	67865	5,18	450	400
K2500HD CLASSIC	4x4	Ext Cab	No	8.0 Box	7.4L V8	4500	6000	8600		n/a	---	---	---	67865	5,18	300	300

- Notes:**
- Ballast amounts are based on a "Representative Vehicle," defined in the vehicle selection guide instructions, and must be modified for all other configurations for axle and GVWR compliance.
 - Classic Style Only (2nd # in model # is 0 not 5) example: K10903. Refer to label in glove box for model number.
 - Recommended F60 suspension or snowplow prep package.

1998 Chevy/GMC

Section 2

PRO-PLOW®, PRO PLUS® & Heavy Weight Blades

PRO-PLOW®					PRO PLUS®			
7'-6" STEEL	7'-6" POLY	8'-0" STEEL	8'-0" POLY	8'-6" STEEL	7'-6" STEEL	8'-0" STEEL	8'-6" STEEL	9'-0" STEEL
IUTP75	IUTPY75	IUTP80	IUTPY80	IUTP85	IUTPP75	IUTPP80	IUTPP85	IUTPP90
60381	62400	60390	62450	60308	64750	66980	66974	66901
Blade Assembly			67950			66490		
AQ&L Assembly Box 1			67951-2					
AQ&L Assembly Box 2			64588			64999		
Hydraulic Kit								
Light Kit			28800					
Choose a Joystick Control			56369					
or Hand-Held Control			56462					

Heavy Weight	
9'-0" STEEL	10'-0" STEEL
IUHW90	IUHW10
62301	62302
62298-1	
62299-1	
64400	
28800	
56369	
56462	

Model	Body Style	DRW	Box Option	Engine Type	Min F G A W R	Min R C A W R	Min G V W R	Harness Kit	UltraMount® system		Ballast Guidelines, lbs (1)																UniMount® system		Ballast Guidelines, lbs (1)	
									Mount Kit	Notes	Mount Kit	Notes	Mount Kit	Notes	Mount Kit	Notes	Mount Kit	Notes	Mount Kit	Notes	Mount Kit	Notes	Mount Kit	Notes						
TAHOE/YUKON 1500	4x4	SU-2DR	No	---	5.7L V8	3925	3750	6250	67865	5,18	200	250	250	---	---	---	---	---	---	---	---	---	---	---	n/a	---	---	---		
SUBURBAN K1500	4x4	SU-4DR	No	---	5.7L V8	3925	4800	8050	67865	5,18	100	---	200	---	---	---	---	---	---	---	---	---	---	---	n/a	---	---	---		
SUBURBAN K1500	4x4	SU-4DR	No	---	5.7L V8	3925	4000	7300	67865	5,18	100	---	200	---	---	---	---	---	---	---	---	---	---	n/a	---	---	---			
SUBURBAN K2500	4x4	SU-4DR	No	---	5.7L V8	4250	6000	8600	67865	5,18	0	0	0	0	---	---	---	---	---	---	---	---	---	n/a	---	---	---			
K1500 CLASSIC	4x4	Reg Cab	No	6.5 Box	4.3L V6	3925	3750	6100	67865	5,18	500	550	550	550	---	---	---	---	---	---	---	---	---	n/a	---	---	---			
K1500 CLASSIC	4x4	Ext Cab	No	6.5 Box	4.3L V6	3925	3750	6800	67865	5,18	400	550	400	600	500	---	---	---	---	---	---	---	---	n/a	---	---	---			
K1500 CLASSIC	4x4	Ext Cab	No	6.5 Box	4.3L V6	3925	3750	6600	67865	5,18	400	550	400	600	500	---	---	---	---	---	---	---	---	n/a	---	---	---			
K1500 CLASSIC	4x4	Ext Cab	No	6.5 Box	4.3L V6	3925	3750	6200	67865	5,18	450	---	---	---	---	---	---	---	---	---	---	---	---	n/a	---	---	---			
K1500 CLASSIC	4x4	Ext Cab	No	6.5 Box	5.0L V8	3925	3750	6800	67865	5,18	800	---	---	---	---	---	---	---	---	---	---	---	---	n/a	---	---	---			
K1500 CLASSIC	4x4	Ext Cab	No	6.5 Box	5.7L V8	3925	3750	6800	67865	5,18	850	---	---	---	---	---	---	---	---	---	---	---	---	n/a	---	---	---			
K1500 W/T CLASSIC	4x4	Reg Cab	No	6.5 Box	4.3L V6	3925	3750	6100	67865	5,18	600	650	600	650	600	---	---	---	---	---	---	---	---	n/a	---	---	---			
K1500 W/T CLASSIC	4x4	Reg Cab	No	8.0 Box	4.3L V6	3925	3750	6100	67865	5,18	600	---	---	---	---	---	---	---	---	---	---	---	---	n/a	---	---	---			
K2500 CLASSIC	4x4	Ext Cab	No	6.5 Box	5.7L V8	4500	6000	8600	67865	5,18	400	450	450	450	550	550	600	600	---	---	---	---	n/a	---	---	---				
K2500 CLASSIC	4x4	Ext Cab	No	6.5 Box	5.7L V8	4250	6000	8600	67865	5,18	450	750	550	800	700	---	---	---	---	---	---	---	---	n/a	---	---	---			
K2500 CLASSIC	4x4	Ext Cab	No	6.5 Box	6.5L D	4500	6000	8600	67865	5,18	950	---	---	---	---	---	---	---	---	---	---	---	---	n/a	---	---	---			
K2500 CLASSIC	4x4	Ext Cab	No	6.5 Box	7.4L V8	4500	6000	8600	67865	5,18	500	750	600	850	700	---	---	---	---	---	---	---	n/a	---	---	---				
K2500 CLASSIC	4x4	All	No	Chassis	All	All	All	8501	67865	5,18	?	?	?	?	?	?	?	?	?	?	?	?	n/a	---	---	---				
K2500HD CLASSIC	4x4	Reg Cab	No	8.0 Box	5.7L V8	4500	6000	8600	67865	5,18	500	550	500	550	500	600	650	650	650	---	---	---	---	n/a	---	---	---			
K2500HD CLASSIC	4x4	Reg Cab	No	8.0 Box	5.7L V8	4250	6000	8600	67865	5,18	500	650	500	650	600	---	---	---	---	---	---	---	n/a	---	---	---				
K2500HD CLASSIC	4x4	Reg Cab	No	8.0 Box	6.5L D	4500	6000	8600	67865	5,18	500	650	500	700	600	---	---	---	---	---	---	---	n/a	---	---	---				
K2500HD CLASSIC	4x4	Reg Cab	No	8.0 Box	7.4L V8	4500	6000	8600	67865	5,18	550	700	550	700	650	---	---	---	---	---	---	---	n/a	---	---	---				
K2500HD CLASSIC	4x4	Ext Cab	No	8.0 Box	5.7L V8	4500	6000	8600	67865	5,18	350	400	400	400	400	550	650	750	850	---	---	---	---	n/a	---	---	---			
K2500HD CLASSIC	4x4	Ext Cab	No	8.0 Box	5.7L V8	4250	6000	8600	67865	5,18	900	---	---	---	---	---	---	---	---	---	---	---	---	n/a	---	---	---			
K2500HD CLASSIC	4x4	Ext Cab	No	8.0 Box	7.4L V8	4500	6000	8600	67865	5,18	900	---	1000	---	---	---	---	---	---	---	---	---	---	n/a	---	---	---			
K3500 CLASSIC	4x4	Reg Cab	No	8.0 Box	5.7L V8	4500	6084	9200	67865	5,18	400	400	400	450	400	500	500	550	600	---	---	---	---	n/a	---	---	---			
K3500 CLASSIC	4x4	Reg Cab	No	8.0 Box	5.7L V8	4250	6084	9200	67865	5,18	550	800	650	850	750	---	---	---	---	---	---	---	n/a	---	---	---				
K3500 CLASSIC	4x4	Reg Cab	No	8.0 Box	6.5L D	4500	6084	9200	67865	5,18	800	---	900	---	1000	---	---	---	---	---	---	---	---	n/a	---	---	---			
K3500 CLASSIC	4x4	Reg Cab	No	8.0 Box	7.4L V8	4500	6084	9200	67865	5,18	500	650	500	700	600	---	---	---	---	---	---	---	n/a	---	---	---				
K3500 CLASSIC	4x4	Reg Cab	Yes	8.0 Box	5.7L V8	4500	7500	10000	67865	5,18	---	---	---	---	250	---	---	650	750	---	---	---	---	n/a	---	---	---			
K3500 CLASSIC	4x4	Reg Cab	Yes	8.0 Box	5.7L V8	4250	7500	10000	67865	5,18	---	---	---	---	950	---	---	---	---	---	---	---	---	n/a	---	---	---			
K3500 CLASSIC	4x4	Reg Cab	Yes	8.0 Box	7.4L V8	4500	7500	10000	67865	5,18	---	---	---	---	800	---	---	---	---	---	---	---	---	n/a	---	---	---			
K3500 CLASSIC	4x4	Ext Cab	Yes	8.0 Box	5.7L V8	4500	7500	10000	67865	5,18	---	---	---	---	100	---	---	900	1000	---	---	---	---	n/a	---	---	---			
K3500 CLASSIC	4x4	All	No	Chassis	All	All	All	8501	67865	5,18	?	?	?	?	?	?	?	?	?	?	?	?	n/a	---	---	---				
K3500 CLASSIC	4x4	All	Yes	Chassis	All	All	All	10000	67865	5,18	---	---	---	---	?	---	---	?	?	---	---	---	---	n/a	---	---	---			
K3500 CLASSIC (St Frame)	4x4	All	Yes	Chassis	All	All	All	10000	67865	5,18	---	---	---	---	?	---	---	?	?	---	---	---	---	n/a	---	---	---			
4500/5500 (Low Pro)	4x2	All	Yes	Chassis	All	All	All	10001	n/a	---	---	---	---	---	---	---	---	---	---	---	---	---	---	62275	---	?	?			
4500/5500 T-40	4x2	All	Yes	Chassis	All	All	All	10001	n/a	---	---	---	---	---	---	---	---	---	---	---	---	---	---	62275	---	?	?			
4500/5500 T-50	4x2	All	Yes	Chassis	All	All	All	10001	n/a	---	---	---	---	---	---	---	---	---	---	---	---	---	---	62275	---	?	?			

Notes:
 1. Ballast amounts are based on a "Representative Vehicle," defined in the vehicle selection guide instructions, and must be modified for all other configurations for axle and GVWR compliance.

5. Classic Style Only (2nd # in model # is 0 not 5) example: K10903. Refer to label in glove box for model number.
 18. Recommended F60 suspension or snowplow prep package.

1998 Chevy/GMC

Section 3

MVP® & MVP PLUS™ Blades

UltraMount							
MVP®	MVP PLUS™						
8'-6" STEEL	7'-6" STEEL	7'-6" POLY	8'-6" STEEL	8'-6" POLY	9'-6" STEEL	9'-6" POLY	
Plow	IUMVP85	IUTHVPP75	IUTHVPPY75	IUTHVPP85	IUTHVPPY85	IUTHVPP95	IUTHVPPY95
Blade Assembly	63819	44475	44575	44485	44585	44495	44595
AQ&L Assembly Box 1	63910						
AQ&L Assembly Box 2	67951-2						
Hydraulic Kit	64777	44225					
Light Kit	28800						
Choose a Joystick Control or Hand-Held Control	96369						96700
	96462						96600

Model	4x4	Body Style	DRW	Box Option	Engine Type	Min F G A W R	Min R G A W R	Min G V W R	Harness Kit	UltraMount® system		750	550	500	550	550	---	---
										Mount Kit	Notes							
K2500 CLASSIC	4x4	Ext Cab	No	6.5 Box	5.7L V8	4500	6000	8600	2B use 8439 or HB3/HB4 use 8438	67865	5,18	750	550	500	550	550	---	---
K2500 CLASSIC	4x4	All	No	Chassis	All	All	All	8501		67865	5,18	?	?	?	?	?	?	?
K2500HD CLASSIC	4x4	Reg Cab	No	8.0 Box	5.7L V8	4500	6000	8600		67865	5,18	700	600	550	650	600	---	900
K2500HD CLASSIC	4x4	Reg Cab	No	8.0 Box	5.7L V8	4250	6000	8600		67865	5,18	---	---	1000	---	---	---	---
K2500HD CLASSIC	4x4	Reg Cab	No	8.0 Box	6.5L D	4500	6000	8600		67865	5,18	---	---	1000	---	---	---	---
K2500HD CLASSIC	4x4	Ext Cab	No	8.0 Box	5.7L V8	4500	6000	8600		67865	5,18	---	600	450	900	700	---	---
K3500 CLASSIC	4x4	Reg Cab	No	8.0 Box	5.7L V8	4500	6084	9200		67865	5,18	850	500	450	600	500	---	---
K3500 CLASSIC	4x4	Reg Cab	No	8.0 Box	7.4L V8	4500	6084	9200		67865	5,18	---	---	1000	---	---	---	---
K3500 CLASSIC	4x4	Reg Cab	Yes	8.0 Box	5.7L V8	4500	7500	10000		67865	5,18	---	---	---	800	600	---	---
K3500 CLASSIC	4x4	Ext Cab	Yes	8.0 Box	5.7L V8	4500	7500	10000		67865	5,18	---	---	---	---	850	---	---
K3500 CLASSIC	4x4	All	No	Chassis	All	All	All	8501		67865	5,18	?	?	?	?	?	?	?
K3500 CLASSIC	4x4	All	Yes	Chassis	All	All	All	10000		67865	5,18	?	---	---	?	?	?	?
K3500 CLASSIC (St Frame)	4x4	All	Yes	Chassis	All	All	All	10000		67865	5,18	?	---	---	?	?	?	?

- Notes:**
- Ballast amounts are based on a "Representative Vehicle," defined in the vehicle selection guide instructions, and must be modified for all other configurations for axle and GVWR compliance.
 - Classic Style Only (2nd # in model # is 0 not 5) example: K10903. Refer to label in glove box for model number.
 - Recommended F60 suspension or snowplow prep package.

1998 Dodge

Section 1 Suburbanite™ & MIDWEIGHT™ Blades

 Suburbanite™	
6'-8" POLY	7'-4" POLY
SUB68	SUB74
Plow Blade Assembly	27546 27548
AQ&L Assembly Box 1	27550
AQ&L Assembly Box 2	n/a
Hydraulic Kit	27516
Light Kit	64100
Choose a Joystick Control or Hand-Held Control	56369 56462

 MIDWEIGHT™	
7'-6" STEEL	7'-6" POLY
IUTH75	IUTHY75
64340	64330
64336	
67992	
64620	
28800	
56369	
56462	

Model	Body Style	DRW	Box Option	Engine Type	Min F G A W R	Min R G A W R	Min G V W R	Harness Kit	Personal Plow system		Ballast Guidelines, lbs (1)	UltraMount® system		Ballast Guidelines, lbs (1)		
									Mount Kit	Notes		Mount Kit	Notes			
RAM 1500	4x4	Reg Cab	No	6.5 Box	5.2L V8	3850	3600	6400	n/a	---	---	---	67980	23	350	350
RAM 1500	4x4	Reg Cab	No	6.5 Box	5.9L V8	3850	3600	6400	n/a	---	---	---	67980	23	350	350
RAM 1500	4x4	Reg Cab	No	8.0 Box	5.2L V8	3850	3600	6400	n/a	---	---	---	67980	23	350	350
RAM 1500	4x4	Reg Cab	No	8.0 Box	5.9L V8	3850	3600	6400	n/a	---	---	---	67980	23	450	400
RAM 2500HD	4x4	Reg Cab	No	8.0 Box	5.9L D	4850	6084	8800	n/a	---	---	---	67980	23	450	450
RAM 2500HD	4x4	Reg Cab	No	8.0 Box	5.9L V8	4850	6084	8800	n/a	---	---	---	67980	23	200	200
RAM 2500HD	4x4	Reg Cab	No	8.0 Box	8.0L V10	4850	6084	8800	n/a	---	---	---	67980	23	300	300
RAM 2500HD	4x4	Ext Cab	No	6.5 Box	5.9L D	4850	6084	8800	n/a	---	---	---	67980	23	450	450
RAM 2500HD	4x4	Ext Cab	No	6.5 Box	5.9L V8	4850	6084	8800	n/a	---	---	---	67980	23	250	200
RAM 2500HD	4x4	Ext Cab	No	6.5 Box	8.0L V10	4850	6084	8800	n/a	---	---	---	67980	23	400	400
RAM 2500HD	4x4	Ext Cab	No	8.0 Box	5.9L D	4850	6084	8800	n/a	---	---	---	67980	23	550	500
RAM 2500HD	4x4	Ext Cab	No	8.0 Box	5.9L V8	4850	6084	8800	n/a	---	---	---	67980	23	200	200
RAM 2500HD	4x4	Ext Cab	No	8.0 Box	8.0L V10	4850	6084	8800	n/a	---	---	---	67980	23	200	200
RAM 2500HD	4x4	Quad Cab	No	6.5 Box	5.9L D	4850	6084	8800	n/a	---	---	---	67980	23	500	500
RAM 2500HD	4x4	Quad Cab	No	6.5 Box	5.9L V8	4850	6084	8800	n/a	---	---	---	67980	23	200	200
RAM 2500HD	4x4	Quad Cab	No	6.5 Box	8.0L V10	4850	6084	8800	n/a	---	---	---	67980	23	400	400
RAM 2500HD	4x4	Quad Cab	No	8.0 Box	5.9L D	4850	6084	8800	n/a	---	---	---	67980	23	600	550
RAM 2500HD	4x4	Quad Cab	No	8.0 Box	5.9L V8	4850	6084	8800	n/a	---	---	---	67980	23	200	200
RAM 2500HD	4x4	Quad Cab	No	8.0 Box	8.0L V10	4850	6084	8800	n/a	---	---	---	67980	23	200	200
RAM 2500HD	4x4	All	No	Chassis	All	All	All	8501	n/a	---	---	---	67980	23	?	?

Choose a Joystick Control
or Hand-Held Control

HB1 use
8436

- Notes:**
- Ballast amounts are based on a "Representative Vehicle," defined in the vehicle selection guide instructions, and must be modified for all other configurations for axle and GVWR compliance.
 - Requires bumper notching on Sport and LE Sport option.

1998 Dodge

Section 2 PRO-PLOW®, PRO PLUS® & Heavy Weight Blades

UltraMount								
PRO-PLOW®					PRO PLUS®			
7'-6" STEEL	7'-6" POLY	8'-0" STEEL	8'-0" POLY	8'-6" STEEL	7'-6" STEEL	8'-0" STEEL	8'-6" STEEL	9'-0" STEEL
IUTP75	IUTPY75	IUTP80	IUTPY80	IUTP85	IUTPP75	IUTPP80	IUTPP85	IUTPP90
60381	62400	60390	62450	60308	64750	66980	66974	66901
67950					66490			
64588					64999			
28800					56369			
56369					56462			

UniMount	
Heavy Weight	
9'-0" STEEL	10'-0" STEEL
IUHW90	IUHW10
62301	62302
62298-1	
62299-1	
64400	
28800	
56369	
56462	

Model	Body Style	DRW	Box Option	Engine Type	Min F G A W R	Min R G A W R	Min G V W R	Harness Kit	UltraMount® system		Ballast Guidelines, lbs (1)								UniMount® system		Ballast Guidelines, lbs (1)			
									Mount Kit	Notes	Mount Kit	Notes	Mount Kit	Notes	Mount Kit	Notes	Mount Kit	Notes						
RAM 2500HD	4x4	Reg Cab	No	8.0 Box	5.9L D	4850	6084	8800	67980	23	600	850	700	900	800	---	---	---	---	n/a	---	---	---	---
RAM 2500HD	4x4	Reg Cab	No	8.0 Box	5.9L V8	4850	6084	8800	67980	23	350	400	350	400	350	450	500	500	500	n/a	---	---	---	---
RAM 2500HD	4x4	Reg Cab	No	8.0 Box	8.0L V10	4850	6084	8800	67980	23	450	500	450	500	450	550	600	600	600	n/a	---	---	---	---
RAM 2500HD	4x4	Ext Cab	No	6.5 Box	5.9L D	4850	6084	8800	67980	23	850	---	950	---	---	---	---	---	---	n/a	---	---	---	---
RAM 2500HD	4x4	Ext Cab	No	6.5 Box	5.9L V8	4850	6084	8800	67980	23	350	400	400	400	400	500	500	550	550	n/a	---	---	---	---
RAM 2500HD	4x4	Ext Cab	No	6.5 Box	8.0L V10	4850	6084	8800	67980	23	550	550	550	600	550	650	700	700	750	n/a	---	---	---	---
RAM 2500HD	4x4	Ext Cab	No	8.0 Box	5.9L V8	4850	6084	8800	67980	23	350	400	350	400	350	450	450	500	500	n/a	---	---	---	---
RAM 2500HD	4x4	Ext Cab	No	8.0 Box	8.0L V10	4850	6084	8800	67980	23	350	400	350	400	400	450	500	500	600	n/a	---	---	---	---
RAM 2500HD	4x4	Quad Cab	No	6.5 Box	5.9L D	4850	6084	8800	67980	23	950	---	---	---	---	---	---	---	---	n/a	---	---	---	---
RAM 2500HD	4x4	Quad Cab	No	6.5 Box	5.9L V8	4850	6084	8800	67980	23	350	400	350	400	400	500	500	500	550	n/a	---	---	---	---
RAM 2500HD	4x4	Quad Cab	No	6.5 Box	8.0L V10	4850	6084	8800	67980	23	500	550	550	550	550	650	650	750	850	n/a	---	---	---	---
RAM 2500HD	4x4	Quad Cab	No	8.0 Box	5.9L V8	4850	6084	8800	67980	23	300	350	350	350	350	450	450	500	500	n/a	---	---	---	---
RAM 2500HD	4x4	Quad Cab	No	8.0 Box	8.0L V10	4850	6084	8800	67980	23	350	400	350	400	350	450	500	600	700	n/a	---	---	---	---
RAM 2500HD	4x4	All	No	Chassis	All	All	All	8501	67980	23	?	?	?	?	?	?	?	?	?	n/a	---	---	---	---
RAM 3500	4x4	Reg Cab	Yes	8.0 Box	5.9L D	4850	7500	10500	67980	23	---	---	---	---	900	---	---	---	---	n/a	---	---	---	---
RAM 3500	4x4	Reg Cab	Yes	8.0 Box	5.9L V8	4850	7500	10500	67980	23	---	---	---	---	300	---	---	450	450	n/a	---	---	---	---
RAM 3500	4x4	Reg Cab	Yes	8.0 Box	8.0L V10	4850	7500	10500	67980	23	---	---	---	---	450	---	---	550	600	n/a	---	---	---	---
RAM 3500	4x4	Quad Cab	Yes	8.0 Box	5.9L V8	4850	7500	11000	67980	23	---	---	---	---	150	---	---	300	300	n/a	---	---	---	---
RAM 3500	4x4	Quad Cab	Yes	8.0 Box	8.0L V10	4850	7500	11000	67980	23	---	---	---	---	550	---	---	---	---	n/a	---	---	---	---
RAM 3500	4x4	All	Yes	Chassis	All	All	All	10000	67980	23	---	---	---	---	?	---	---	?	?	n/a	---	---	---	---
RAM 3500	4x2	Reg Cab	Yes	8.0 Box	5.9L D	4500	7500	10500	67980	23	---	---	---	---	950	---	---	---	---	n/a	---	---	---	---
RAM 3500	4x2	Reg Cab	Yes	8.0 Box	5.9L V8	4500	7500	10500	67980	23	---	---	---	---	200	---	---	300	300	n/a	---	---	---	---
RAM 3500	4x2	Reg Cab	Yes	8.0 Box	8.0L V10	4500	7500	10500	67980	23	---	---	---	---	100	---	---	250	250	n/a	---	---	---	---
RAM 3500	4x2	Quad Cab	Yes	8.0 Box	5.9L V8	4500	7500	10500	67980	23	---	---	---	---	0	---	---	250	350	n/a	---	---	---	---
RAM 3500	4x2	Quad Cab	Yes	8.0 Box	8.0L V10	4500	7500	10500	67980	23	---	---	---	---	400	---	---	---	---	n/a	---	---	---	---
RAM 3500	4x2	All	Yes	Chassis	All	All	All	10001	67980	23	---	---	---	---	?	---	---	?	?	n/a	---	---	---	---

Notes:
 1. Ballast amounts are based on a "Representative Vehicle," defined in the vehicle selection guide instructions, and must be modified for all other configurations for axle and GVWR compliance.
 23. Requires bumper notching on Sport and LE Sport option.

1998 Dodge

Section 3 MVP® & MVP PLUS™ Blades

MVP®	MVP PLUS™					
8'-6" STEEL	7'-6" STEEL	7'-6" POLY	8'-6" STEEL	8'-6" POLY	9'-6" STEEL	9'-6" POLY
IUMVP85	IUTHVPP75	IUTHVPPY75	IUTHVPP85	IUTHVPPY85	IUTHVPP95	IUTHVPPY95
Blade Assembly	63819	44475	44575	44485	44585	44495
AQ&L Assembly Box 1	63910					
AQ&L Assembly Box 2	67951-2	44225				
Hydraulic Kit	64777					
Light Kit	28800					
Choose a Joystick Control	96369	96700				
or Hand-Held Control	96462	96600				

Model	Body Style	DRW	Box Option	Engine Type	Min F G A W R	Min R G A W R	Min G V W R	Harness Kit	UltraMount® system		PLOW						
									Mount Kit	Notes	Blade Assembly	AQ&L Assembly Box 1	AQ&L Assembly Box 2	Hydraulic Kit	Light Kit	Choose a Joystick Control	or Hand-Held Control
RAM 2500HD	4x4	Reg Cab	No	8.0 Box	5.9L V8	4850	6084	8800	67980	23	550	450	400	500	450	600	550
RAM 2500HD	4x4	Reg Cab	No	8.0 Box	8.0L V10	4850	6084	8800	67980	23	750	550	500	600	550	---	950
RAM 2500HD	4x4	Ext Cab	No	6.5 Box	5.9L V8	4850	6084	8800	67980	23	600	500	450	550	500	650	600
RAM 2500HD	4x4	Ext Cab	No	6.5 Box	8.0L V10	4850	6084	8800	67980	23	---	650	600	800	650	---	---
RAM 2500HD	4x4	Ext Cab	No	8.0 Box	5.9L V8	4850	6084	8800	67980	23	550	450	400	500	450	600	550
RAM 2500HD	4x4	Ext Cab	No	8.0 Box	8.0L V10	4850	6084	8800	67980	23	950	450	450	650	450	---	---
RAM 2500HD	4x4	Quad Cab	No	6.5 Box	5.9L V8	4850	6084	8800	67980	23	600	450	450	500	500	650	600
RAM 2500HD	4x4	Quad Cab	No	6.5 Box	8.0L V10	4850	6084	8800	67980	23	---	650	600	900	650	---	---
RAM 2500HD	4x4	Quad Cab	No	8.0 Box	5.9L V8	4850	6084	8800	67980	23	550	450	400	450	450	600	550
RAM 2500HD	4x4	Quad Cab	No	8.0 Box	8.0L V10	4850	6084	8800	67980	23	1000	450	400	750	550	---	---
RAM 2500HD	4x4	All	No	Chassis	All	All	All	8501	67980	23	?	?	?	?	?	?	?
RAM 3500	4x4	Reg Cab	Yes	8.0 Box	5.9L V8	4850	7500	10500	67980	23	500	---	---	450	400	550	500
RAM 3500	4x4	Reg Cab	Yes	8.0 Box	8.0L V10	4850	7500	10500	67980	23	850	---	---	600	550	---	---
RAM 3500	4x4	Quad Cab	Yes	8.0 Box	5.9L V8	4850	7500	11000	67980	23	500	---	---	300	250	---	750
RAM 3500	4x4	All	Yes	Chassis	All	All	All	10000	67980	23	?	---	---	?	?	?	?
RAM 3500	4x2	Reg Cab	Yes	8.0 Box	5.9L V8	4500	7500	10500	67980	23	350	---	---	300	250	400	400
RAM 3500	4x2	Reg Cab	Yes	8.0 Box	8.0L V10	4500	7500	10500	67980	23	400	---	---	200	200	900	650
RAM 3500	4x2	Quad Cab	Yes	8.0 Box	5.9L V8	4500	7500	10500	67980	23	700	---	---	400	200	---	950
RAM 3500	4x2	All	Yes	Chassis	All	All	All	10001	67980	23	?	---	---	?	?	?	?

- Notes:**
- Ballast amounts are based on a "Representative Vehicle," defined in the vehicle selection guide instructions, and must be modified for all other configurations for axle and GVWR compliance.
 - Requires bumper notching on Sport and LE Sport option.

1998 Ford

Section 1 Suburbanite™ & MIDWEIGHT™ Blades

 Suburbanite™	
6'-8" POLY	7'-4" POLY
SUB68	SUB74
Plow	
Blade Assembly	27546 27548
AQ&L Assembly Box 1	27550
AQ&L Assembly Box 2	n/a
Hydraulic Kit	27516
Light Kit	64100
Choose a Joystick Control	56369
or Hand-Held Control	56462

 UltraMount™	
MIDWEIGHT™	
7'-6" STEEL	7'-6" POLY
IUTH75	IUTHY75
64340	64330
64336	
67992	
64620	
28800	
56369	
56462	

Model	Body Style	DRW	Box Option	Engine Type	Min F G A W R	Min R G A W R	Min G V W R	Harness Kit	Personal Plow system		Ballast Guidelines, lbs (1)	UltraMount® system		Ballast Guidelines, lbs (1)		
									Mount Kit	Notes		Mount Kit	Notes			
EXPLORER	AWD	SU-4DR	No	---	5.0L V8	2800	3000	5640	1203	3,8	50	150	n/a	---	---	---
EXPLORER	AWD	SU-4DR	No	---	5.0L V8	2800	3000	5580	1203	3,8	50	150	n/a	---	---	---
EXPLORER	4x4	SU-4DR	No	---	4.0L V6	2800	3000	5520	1203	3,8	200	300	n/a	---	---	---
EXPLORER	4x4	SU-4DR	No	---	4.0L V6	2800	3000	5480	1203	3,8	200	300	n/a	---	---	---
EXPLORER	4x4	SU-4DR	No	---	4.0L V6	2800	3000	5440	1203	3,8	200	300	n/a	---	---	---
EXPLORER	4x4	SU-4DR	No	---	4.0L V6	2800	3000	5340	1203	3,8	200	300	n/a	---	---	---
EXPEDITION	4x4	SU-4DR	No	---	4.6L V8	3450	4200	7200	1223	3,8	---	0	67810	2,10	---	---
EXPEDITION	4x4	SU-4DR	No	---	4.6L V8	3450	4200	7000	1223	3,8	---	0	67810	2,10	---	---
EXPEDITION	4x4	SU-4DR	No	---	4.6L V8	3450	4128	7200	1223	3,8	---	0	67810	2,10	---	---
EXPEDITION	4x4	SU-4DR	No	---	4.6L V8	3450	4128	7000	1223	3,8	---	0	67810	2,10	---	---
EXPEDITION	4x4	SU-4DR	No	---	5.4L V8	3450	4200	7200	1223	3,8	---	150	67810	2,10	---	---
EXPEDITION	4x4	SU-4DR	No	---	5.4L V8	3450	4128	7200	1223	3,8	---	150	67810	2,10	---	---
RANGER	4x4	Reg Cab	No	6.0 Box	3.0L V6	2640	2750	4960	1203	8,10	150	150	n/a	---	---	---
RANGER	4x4	Reg Cab	No	6.0 Box	3.0L V6	2640	2750	4660	1203	8,10	150	150	n/a	---	---	---
RANGER	4x4	Reg Cab	No	6.0 Box	3.0L V6	2540	2750	4960	1203	8,10	350	450	n/a	---	---	---
RANGER	4x4	Reg Cab	No	6.0 Box	3.0L V6	2540	2750	4660	1203	8,10	350	450	n/a	---	---	---
RANGER	4x4	Reg Cab	No	6.0 Box	3.0L V6	2420	2750	4960	1203	8,10	800	---	n/a	---	---	---
RANGER	4x4	Reg Cab	No	6.0 Box	4.0L V6	2640	2750	4960	1203	8,10	200	300	n/a	---	---	---
RANGER	4x4	Reg Cab	No	6.0 Box	4.0L V6	2640	2750	4660	1203	8,10	200	300	n/a	---	---	---
RANGER	4x4	Reg Cab	No	6.0 Box	4.0L V6	2540	2750	4960	1203	8,10	550	650	n/a	---	---	---
RANGER	4x4	Reg Cab	No	6.0 Box	4.0L V6	2540	2750	4660	1203	8,10	550	---	n/a	---	---	---
RANGER	4x4	Reg Cab	No	7.0 Box	3.0L V6	2640	2750	4980	1203	8,10	150	150	n/a	---	---	---
RANGER	4x4	Reg Cab	No	7.0 Box	3.0L V6	2640	2570	4680	1203	8,10	150	150	n/a	---	---	---
RANGER	4x4	Reg Cab	No	7.0 Box	3.0L V6	2540	2750	4980	1203	8,10	350	450	n/a	---	---	---
RANGER	4x4	Reg Cab	No	7.0 Box	3.0L V6	2540	2570	4680	1203	8,10	350	450	n/a	---	---	---
RANGER	4x4	Reg Cab	No	7.0 Box	3.0L V6	2420	2750	4980	1203	8,10	750	---	n/a	---	---	---
RANGER	4x4	Reg Cab	No	7.0 Box	4.0L V6	2640	2750	4980	1203	8,10	300	350	n/a	---	---	---
RANGER	4x4	Reg Cab	No	7.0 Box	4.0L V6	2640	2570	4680	1203	8,10	300	350	n/a	---	---	---
RANGER	4x4	Reg Cab	No	7.0 Box	4.0L V6	2540	2750	4980	1203	8,10	600	700	n/a	---	---	---
RANGER	4x4	Ext Cab	No	6.0 Box	3.0L V6	2720	2750	5100	1203	8,10	350	500	n/a	---	---	---
RANGER	4x4	Ext Cab	No	6.0 Box	3.0L V6	2720	2570	4920	1203	8,10	350	500	n/a	---	---	---
RANGER	4x4	Ext Cab	No	6.0 Box	4.0L V6	2720	2750	5100	1203	8,10	700	---	n/a	---	---	---
RANGER	4x4	Super Cab	No	6.0 Box	3.0L V6	2640	2750	5100	1203	8,10	750	---	n/a	---	---	---
RANGER SPLASH	4x4	Reg Cab	No	6.0 Box	3.0L V6	2540	2750	5000	1203	8,10	500	600	n/a	---	---	---
RANGER SPLASH	4x4	Reg Cab	No	6.0 Box	3.0L V6	2540	2570	4740	1203	8,10	500	600	n/a	---	---	---
RANGER SPLASH	4x4	Reg Cab	No	6.0 Box	4.0L V6	2540	2750	5000	1203	8,10	700	800	n/a	---	---	---
RANGER SPLASH	4x4	Ext Cab	No	6.0 Box	3.0L V6	2720	2750	5160	1203	8,10	500	650	n/a	---	---	---
RANGER SPLASH	4x4	Ext Cab	No	6.0 Box	3.0L V6	2720	2570	4960	1203	8,10	500	---	n/a	---	---	---

Choose a Joystick Control or Hand-Held Control

HB5 use 8436

- Notes:**
- Ballast amounts are based on a "Representative Vehicle," defined in the vehicle selection guide instructions, and must be modified for all other configurations for axle and GVWR compliance.
 - Recommended snowplow prep package whenever available.

- Requires bumper notching.
- These Snowplows Are For Personal/Homeowner Use Only.
- May require bumper or air dam notching.

1998 Ford

Section 1 Suburbanite™ & MIDWEIGHT™ Blades

	
Suburbanite™	
6'-8" POLY	7'-4" POLY
SUB68	SUB74
Plow	
Blade Assembly	27546 27548
AQ&L Assembly Box 1	27550
AQ&L Assembly Box 2	n/a
Hydraulic Kit	27516
Light Kit	64100
Choose a Joystick Control	56369
or Hand-Held Control	56462

	
MIDWEIGHT™	
7'-6" STEEL	7'-6" POLY
IUTH75	IUTHY75
64340	64330
64336	
67992	
64620	
28800	
56369	
56462	

Model	Body Style	DRW	Box Option	Engine Type	Min F G A W R	Min R G A W R	Min G V W R	Harness Kit	Personal Plow system		Ballast Guidelines, lbs (1)	UltraMount® system		Ballast Guidelines, lbs (1)		
									Mount Kit	Notes		Mount Kit	Notes			
F150	4x4	Reg Cab	No	6.0 Box	4.2L V6	3200	3550	6050	1223	8	---	50	67810	2,10	---	---
F150	4x4	Reg Cab	No	6.0 Box	4.2L V6	3200	3550	6000	1223	8	---	50	67810	2,10	---	---
F150	4x4	Reg Cab	No	6.0 Box	4.2L V6	3200	3200	6000	1223	8	---	50	67810	2,10	---	---
F150	4x4	Reg Cab	No	6.0 Box	4.2L V6	3000	3550	6000	1223	8	---	550	67810	2,10	---	---
F150	4x4	Reg Cab	No	6.0 Box	4.2L V6	3000	3200	6000	1223	8	---	550	67810	2,10	---	---
F150	4x4	Reg Cab	No	6.0 Box	4.6L V8	3200	3550	6050	1223	8	---	100	67810	2,10	---	---
F150	4x4	Reg Cab	No	6.0 Box	4.6L V8	3200	3550	6000	1223	8	---	100	67810	2,10	---	---
F150	4x4	Reg Cab	No	6.0 Box	4.6L V8	3200	3200	6000	1223	8	---	100	67810	2,10	---	---
F150	4x4	Reg Cab	No	6.0 Box	4.6L V8	3000	3550	6000	1223	8	---	800	67810	2,10	---	---
F150	4x4	Reg Cab	No	6.0 Box	4.6L V8	3000	3200	6000	1223	8	---	800	67810	2,10	---	---
F150	4x4	Reg Cab	No	6.0 Box	5.4L V8	3700	3550	6050	1223	8	---	0	67810	2,10	300	250
F150	4x4	Reg Cab	No	6.0 Box	5.4L V8	3600	3550	6000	1223	8	---	50	67810	2,10	---	---
F150	4x4	Reg Cab	No	6.0 Box	5.4L V8	3400	3550	6000	1223	8	---	50	67810	2,10	---	---
F150	4x4	Reg Cab	No	6.0 Box	5.4L V8	3200	3550	6000	1223	8	---	550	67810	2,10	---	---
F150	4x4	Reg Cab	No	8.0 Box	4.6L V8	3800	3200	6050	1223	8	---	150	67810	2,10	400	400
F150	4x4	Reg Cab	No	8.0 Box	4.6L V8	3800	3200	6000	1223	8	---	150	67810	2,10	400	400
F150	4x4	Reg Cab	No	8.0 Box	4.6L V8	3400	3200	6050	1223	8	---	150	67810	2,10	---	---
F150	4x4	Reg Cab	No	8.0 Box	4.6L V8	3400	3200	6000	1223	8	---	150	67810	2,10	---	---
F150	4x4	Reg Cab	No	8.0 Box	4.6L V8	3200	3200	6050	1223	8	---	600	67810	2,10	---	---
F150	4x4	Reg Cab	No	8.0 Box	4.6L V8	3200	3200	6000	1223	8	---	600	67810	2,10	---	---
F150	4x4	Reg Cab	No	8.0 Box	5.4L V8	3900	3200	6050	1223	8	---	150	67810	2,10	---	400
F150	4x4	Reg Cab	No	8.0 Box	5.4L V8	3800	3200	6050	1223	8	---	150	67810	2,10	---	400
F150	4x4	Reg Cab	No	8.0 Box	5.4L V8	3700	3200	6050	1223	8	---	100	67810	2,10	---	---
F150	4x4	Reg Cab	No	8.0 Box	5.4L V8	3600	3200	6000	1223	8	---	100	67810	2,10	---	---
F150	4x4	Reg Cab	No	8.0 Box	5.4L V8	3400	3200	6000	1223	8	---	400	67810	2,10	---	---
F150	4x4	Ext Cab	No	6.0 Box	4.6L V8	3600	3200	6250	1223	8	---	0	67810	2,10	---	---
F150	4x4	Ext Cab	No	6.0 Box	4.6L V8	3600	3200	6000	1223	8	---	100	67810	2,10	---	---
F150	4x4	Ext Cab	No	6.0 Box	4.6L V8	3400	3200	6250	1223	8	---	0	67810	2,10	---	---
F150	4x4	Ext Cab	No	6.0 Box	4.6L V8	3400	3200	6000	1223	8	---	0	67810	2,10	---	---
F150	4x4	Ext Cab	No	6.0 Box	4.6L V8	3200	3200	6250	1223	8	---	650	67810	2,10	---	---
F150	4x4	Ext Cab	No	6.0 Box	5.4L V8	3700	3200	6250	1223	8	---	0	67810	2,10	---	---
F150	4x4	Ext Cab	No	6.0 Box	5.4L V8	3600	3200	6000	1223	8	---	0	67810	2,10	---	---
F150	4x4	Ext Cab	No	8.0 Box	4.6L V8	3600	3200	6000	1223	8	---	150	67810	2,10	---	---
F150	4x4	Ext Cab	No	8.0 Box	4.6L V8	3400	3200	6000	1223	8	---	300	67810	2,10	---	---
F150	4x4	Ext Cab	No	8.0 Box	5.4L V8	3700	3200	6250	1223	8	---	150	67810	2,10	---	---

HB5 use
8436

- Notes:**
- Ballast amounts are based on a "Representative Vehicle," defined in the vehicle selection guide instructions, and must be modified for all other configurations for axle and GVWR compliance.
 - Recommended snowplow prep package whenever available.

- These Snowplows Are For Personal/Homeowner Use Only.
- May require bumper or air dam notching.

1998 Ford

Section 1 Suburbanite™ & MIDWEIGHT™ Blades

 Suburbanite™	
6'-8" POLY	7'-4" POLY
SUB68	SUB74
Blade Assembly	27546 27548
AQ&L Assembly Box 1	27550
AQ&L Assembly Box 2	n/a
Hydraulic Kit	27516
Light Kit	64100
Choose a Joystick Control or Hand-Held Control	56369 56462

 UltraMount™	
MIDWEIGHT™	
7'-6" STEEL	7'-6" POLY
IUTH75	IUTHY75
64340	64330
64336	
67992	
64620	
28800	
56369	
56462	

Model	4x4	Body Style	DRW	Box Option	Engine Type	Min F G A W R	Min R G A W R	Min G V W R	Harness Kit	Personal Plow system		Ballast Guidelines, lbs (1)	UltraMount® system		Ballast Guidelines, lbs (1)		
										Mount Kit	Notes		Mount Kit	Notes			
F250LD	4x4	Reg Cab	No	8.0 Box	4.6L V8	4150	4800	7200	HB5 use 8436	n/a	---	---	---	67810	2,10	300	300
F250LD	4x4	Reg Cab	No	8.0 Box	4.6L V8	4150	4300	7200		n/a	---	---	---	67810	2,10	300	300
F250LD	4x4	Reg Cab	No	8.0 Box	4.6L V8	3950	4800	7200		n/a	---	---	---	67810	2,10	300	300
F250LD	4x4	Reg Cab	No	8.0 Box	4.6L V8	3950	4300	7200		n/a	---	---	---	67810	2,10	300	300
F250LD	4x4	Reg Cab	No	8.0 Box	4.6L V8	3600	4300	7200		n/a	---	---	---	67810	2,10	---	1000
F250LD	4x4	Reg Cab	No	8.0 Box	5.4L V8	4150	4800	7700		n/a	---	---	---	67810	2,10	350	300
F250LD	4x4	Reg Cab	No	8.0 Box	5.4L V8	4150	4300	7700		n/a	---	---	---	67810	2,10	350	300
F250LD	4x4	Reg Cab	No	8.0 Box	5.4L V8	3950	4800	7700		n/a	---	---	---	67810	2,10	350	300
F250LD	4x4	Reg Cab	No	8.0 Box	5.4L V8	3950	4300	7700		n/a	---	---	---	67810	2,10	350	300
F250LD	4x4	Ext Cab	No	6.5 Box	4.6L V8	3950	4800	7200		n/a	---	---	---	67810	2,10	250	250
F250LD	4x4	Ext Cab	No	6.5 Box	4.6L V8	3600	4300	7200		n/a	---	---	---	67810	2,10	---	1000
F250LD	4x4	Ext Cab	No	6.5 Box	5.4L V8	3950	4800	7700		n/a	---	---	---	67810	2,10	300	300
F250LD	4x4	Ext Cab	No	6.5 Box	5.4L V8	3950	4300	7700		n/a	---	---	---	67810	2,10	300	300

- Notes:**
- Ballast amounts are based on a "Representative Vehicle," defined in the vehicle selection guide instructions, and must be modified for all other configurations for axle and GVWR compliance.
 - Recommended snowplow prep package whenever available.
 - May require bumper or air dam notching.

1998 Ford

Section 2

PRO-PLOW®, PRO PLUS® & Heavy Weight Blades

UltraMount								
PRO-PLOW®					PRO PLUS®			
7'-6" STEEL	7'-6" POLY	8'-0" STEEL	8'-0" POLY	8'-6" STEEL	7'-6" STEEL	8'-0" STEEL	8'-6" STEEL	9'-0" STEEL
IUTP75	IUTPY75	IUTP80	IUTPY80	IUTP85	IUTPP75	IUTPP80	IUTPP85	IUTPP90
60381	62400	60390	62450	60308	64750	66980	66974	66901
67950					66490			
64588					64999			
28800					56369			
56369					56462			

UniMount	
Heavy Weight	
9'-0" STEEL	10'-0" STEEL
IUHW90	IUHW10
62301	62302
62298-1	
62299-1	
64400	
28800	
56369	
56462	

Plow
Blade Assembly
AQ&L Assembly Box 1
AQ&L Assembly Box 2
Hydraulic Kit
Light Kit
Choose a Joystick Control
or Hand-Held Control

Model	Body Style	DRW	Box Option	Engine Type	Min F G A W R	Min R G A W R	Min G V W R	Harness Kit	UltraMount® system		Ballast Guidelines, lbs (1)								UniMount® system		Ballast Guidelines, lbs (1)			
									Mount Kit	Notes	Mount Kit	Notes	Mount Kit	Notes	Mount Kit	Notes	Mount Kit	Notes						
F250LD	4x4	Reg Cab	No	8.0 Box	4.6L V8	4150	4800	7200	HB5 use 8436	67810	2,10	400	450	450	450	550	600	700	850	n/a	---	---	---	
F250LD	4x4	Reg Cab	No	8.0 Box	4.6L V8	4150	4300	7200		67810	2,10	400	450	450	450	450	550	550	650	750	n/a	---	---	---
F250LD	4x4	Reg Cab	No	8.0 Box	4.6L V8	3950	4800	7200		67810	2,10	600	850	700	900	800	---	---	---	---	n/a	---	---	---
F250LD	4x4	Reg Cab	No	8.0 Box	4.6L V8	3950	4300	7200		67810	2,10	550	800	650	850	750	---	---	---	---	n/a	---	---	---
F250LD	4x4	Reg Cab	No	8.0 Box	5.4L V8	4150	4800	7700		67810	2,10	450	500	500	500	500	1000	---	---	---	n/a	---	---	---
F250LD	4x4	Reg Cab	No	8.0 Box	5.4L V8	4150	4300	7700		67810	2,10	450	500	500	500	500	950	---	---	---	n/a	---	---	---
F250LD	4x4	Reg Cab	No	8.0 Box	5.4L V8	3950	4300	7700		67810	2,10	1000	---	---	---	---	---	---	---	---	n/a	---	---	---
F250LD	4x4	Ext Cab	No	6.5 Box	4.6L V8	3950	4800	7200		67810	2,10	550	850	700	900	800	---	---	---	---	n/a	---	---	---
F250LD	4x4	Ext Cab	No	6.5 Box	4.6L V8	3950	4300	7200		67810	2,10	500	800	650	850	750	---	---	---	---	n/a	---	---	---
F250LD	4x4	Ext Cab	No	6.5 Box	5.4L V8	3950	4300	7700		67810	2,10	1000	---	---	---	---	---	---	---	---	n/a	---	---	---
F700, F800	4x2	All	Yes	Chassis	All	All	All	10001	2B/2D use 8439 & 26640	n/a	---	---	---	---	---	---	---	---	---	62275	---	?	?	
F700, F800 (Low Pro)	4x2	All	Yes	Chassis	All	All	All	10001	n/a	---	---	---	---	---	---	---	---	---	---	62275	---	?	?	

- Notes:**
- Ballast amounts are based on a "Representative Vehicle," defined in the vehicle selection guide instructions, and must be modified for all other configurations for axle and GVWR compliance.
 - Recommended snowplow prep package whenever available.
 - May require bumper or air dam notching.

1998 Ford

Section 3

MVP® & MVP PLUS™ Blades

UltraMount							
MVP®	MVP PLUS™						
8'-6" STEEL	7'-6" STEEL	7'-6" POLY	8'-6" STEEL	8'-6" POLY	9'-6" STEEL	9'-6" POLY	
Plow	IUMVPP85	IUTHVPP75	IUTHVPPY75	IUTHVPP85	IUTHVPPY85	IUTHVPP95	IUTHVPPY95
Blade Assembly	63819	44475	44575	44485	44585	44495	44595
AQ&L Assembly Box 1	63910						
AQ&L Assembly Box 2	67951-2						
Hydraulic Kit	64777	44225					
Light Kit	28800						
Choose a Joystick Control or Hand-Held Control	96369						96700
	96462						96600

Model	Body Style	DRW	Box Option	Engine Type	Min F G A W R	Min R G A W R	Min G V W R	Harness Kit	UltraMount® system		Ballast	Ballast	Ballast	Ballast	Ballast	Ballast			
									Mount Kit	Notes									
F250LD	4x4	Reg Cab	No	8.0 Box	4.6L V8	4150	4800	7200			---	550	500	850	650	---	---		
F250LD	4x4	Reg Cab	No	8.0 Box	4.6L V8	4150	4300	7200	HB5 use 8436		67810	2,10	---	550	500	800	600	---	---
F250LD	4x4	Reg Cab	No	8.0 Box	5.4L V8	4150	4800	7700			67810	2,10	---	1000	850	---	---	---	---
F250LD	4x4	Reg Cab	No	8.0 Box	5.4L V8	4150	4300	7700			67810	2,10	---	950	800	---	---	---	---

- Notes:**
1. Ballast amounts are based on a "Representative Vehicle," defined in the vehicle selection guide instructions, and must be modified for all other configurations for axle and GVWR compliance.
 2. Recommended snowplow prep package whenever available.
 10. May require bumper or air dam notching.

1998 International

Section 2

PRO-PLOW®, PRO PLUS® & Heavy Weight Blades

UltraMount										UniMount																	
PRO-PLOW®					PRO PLUS®					Heavy Weight																	
7'-6" STEEL	7'-6" POLY	8'-0" STEEL	8'-0" POLY	8'-6" STEEL	7'-6" STEEL	8'-0" STEEL	8'-6" STEEL	9'-0" STEEL	9'-0" STEEL	10'-0" STEEL																	
IUTP75	IUTPY75	IUTP80	IUTPY80	IUTP85	IUTPP75	IUTPP80	IUTPP85	IUTPP90	IUHW90	IUHW10																	
60381	62400	60390	62450	60308	64750	66980	66974	66901	62301	62302																	
Plow			67950			66490			62298-1																		
Blade Assembly			67951-2						62299-1																		
AQ&L Assembly Box 1									64400																		
AQ&L Assembly Box 2			64588			64999			28800																		
Hydraulic Kit									56369																		
Light Kit			28800						56462																		
Choose a Joystick Control or Hand-Held Control			56369																								
			56462																								
Model	Body Style	DRW	Box Option	Engine Type	Min F G A W R	Min R G A W R	Min G V W R	Harness Kit	UltraMount® system	Ballast Guidelines, lbs (1)										UniMount® system	Ballast Guidelines, lbs (1)						
									Mount Kit	Notes														Mount Kit	Notes		
4700, 4800,4900	4x2	All	Yes	Chassis	All	All	10001	2B use 8439 & 26640	n/a	---	---	---	---	---	---	---	---	---	---	---	---	62275	---		?	?	
4700, 4800,4900 (Low Pro)	4x2	All	Yes	Chassis	All	All	10001		n/a	---	---	---	---	---	---	---	---	---	---	---	---	62275	---		?	?	

Notes:
1. Ballast amounts are based on a "Representative Vehicle," defined in the vehicle selection guide instructions, and must be modified for all other configurations for axle and GVWR compliance.

1998 Jeep

Section 1 Suburbanite™ & MIDWEIGHT™ Blades

 Suburbanite™	
6'-8" POLY	7'-4" POLY
SUB68	SUB74
Plow Blade Assembly	27546 27548
AQ&L Assembly Box 1	27550
AQ&L Assembly Box 2	n/a
Hydraulic Kit	27516
Light Kit	64100
Choose a Joystick Control or Hand-Held Control	56369 56462

 UltraMount™	
MIDWEIGHT™	
7'-6" STEEL	7'-6" POLY
IUTH75	IUTHY75
64340	64330
64336	
67992	
64620	
28800	
56369	
56462	

Model	4x4	Body Style	DRW	Box Option	Engine Type	Min FGAWR	Min RGAWR	Min GVWR	Harness Kit	Personal Plow system		Ballast Guidelines, lbs (1)	UltraMount® system		Ballast Guidelines, lbs (1)	
										Mount Kit	Notes		Mount Kit	Notes		
WRANGLER	4x4	SU-2DR	No	---	2.5L I4	2500	2600	4360	2D use 8439	3723	8	0 0	n/a	---	---	---
WRANGLER	4x4	SU-2DR	No	---	2.5L I4	2200	2600	4360		3723	8	0 0	n/a	---	---	---

- Notes:**
- Ballast amounts are based on a "Representative Vehicle," defined in the vehicle selection guide instructions, and must be modified for all other configurations for axle and GVWR compliance.
 - These Snowplows Are For Personal/Homeowner Use Only.

1998 Toyota

Section 1 Suburbanite™ & MIDWEIGHT™ Blades

	
Suburbanite™	
6'-8" POLY	7'-4" POLY
SUB68	SUB74
Plow	
Blade Assembly	27546 27548
AQ&L Assembly Box 1	27550
AQ&L Assembly Box 2	n/a
Hydraulic Kit	27516
Light Kit	64100
Choose a Joystick Control or Hand-Held Control	56369 56462

	
MIDWEIGHT™	
7'-6" STEEL	7'-6" POLY
IUTH75	IUTHY75
64340	64330
	64336
	67992
	64620
	28800
	56369
	56462

Model	4x4	Body Style	DRW	Box Option	Engine Type	Min F G A W R	Min R G A W R	Min G V W R	Harness Kit	Personal Plow system		Ballast Guidelines, lbs (1)		UltraMount® system		Ballast Guidelines, lbs (1)	
										Mount Kit	Notes			Mount Kit	Notes		
TACOMA	4x4	Reg Cab	No	8.0 Box	2.7L I4	2650	2800	5000	HB2 use 8439	2313	8	50	100	n/a	---	---	---
TACOMA	4x4	Ext Cab	No	6.5 Box	2.7L I4	2650	2800	5000		2313	8	50	100	n/a	---	---	---
TACOMA	4x4	Ext Cab	No	6.5 Box	3.4L V6	2650	2800	5100		2313	8	100	100	n/a	---	---	---

- Notes:**
- Ballast amounts are based on a "Representative Vehicle," defined in the vehicle selection guide instructions, and must be modified for all other configurations for axle and GVWR compliance.
 - These Snowplows Are For Personal/Homeowner Use Only.

HEADLAMP REFERENCE GUIDE

NOTE: The lamp type is usually embossed in the headlamp lens.

NOTE: Blue ground wires may be LT or DK BLU, w/ or w/o WHT stripe, depending on harness.

Headlamp Type	Bulb Type	Headlamp Type	Bulb Type
LF	H4703	2E1	H6545
UF	H4701	H13	9008
1A1	H4651	HB1	9004
2A1	H4652(GMC/Chevy)	HB2	9003
2A1	H4656 (Mitsubishi)	HB3	9005
2B1	H6054	HB4	9006
2D1	H6024	HB5	9007

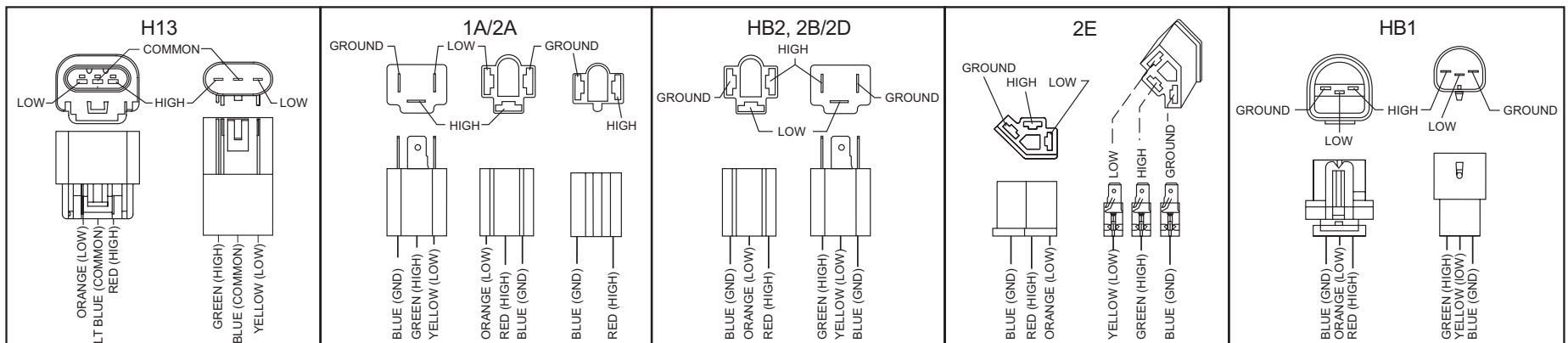
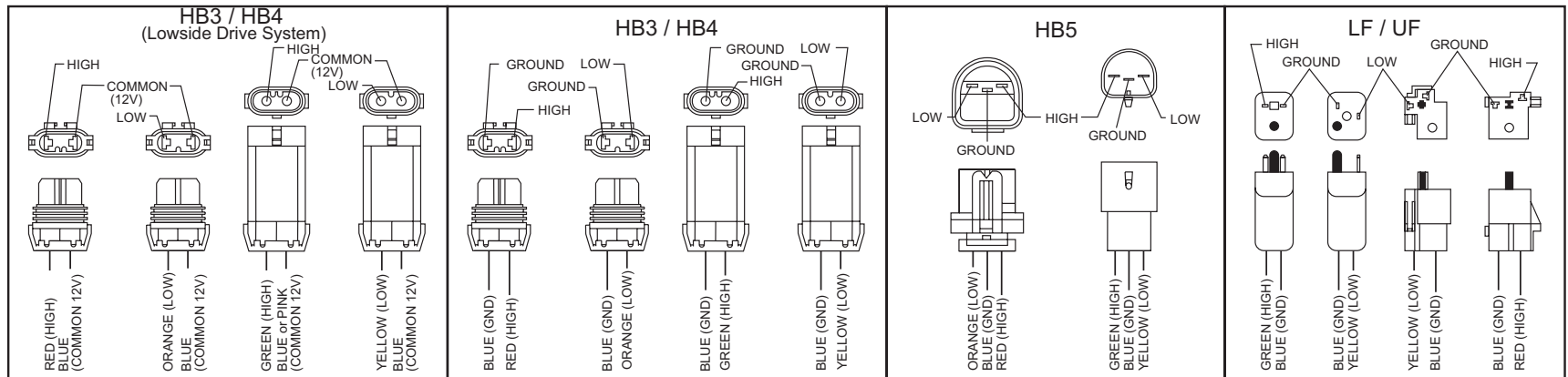

WEIGHT AND DIMENSIONAL CHARTS

Plows and Accessories Information										
Plows		Accessories – Part Number (Effective Added Weight in lb)								Var.
Size	Wt. (lb)	HD Poly Deflector	Rubber Deflector	Cutting Edge 1/2"	Back Drag Edge 1/4"	Wing Kit	Shoes	Curb Guard	Dolly Wheel	Z (in)
SUB68	239	—	—	—	—	—	27710 (5.7)	—	—	20.4
SUB74	257	—	—	—	—	—	27710 (5.7)	—	—	20.8
IUTM75	540	63700 (19.1)	62123 (29.6)	—	64758 (47.0)	—	64392 (21.1)	44404 (61.3)	—	20.4
IUTMY75	532	63700 (19.1)	62123 (29.6)	—	64758 (47.0)	—	64392 (21.1)	44404 (61.6)	—	20.3
IUTP75	682	63700 (19.2)	62123 (29.7)	49346 (25.8)	64758 (47.0)	—	—	44403 (63.8)	—	20.8
IUTPY75	719	—	—	49350 (24.8)	64758 (47.0)	—	—	44403 (58.4)	—	22.7
IUTP80	699	63670 (20.1)	62530 (33.8)	49347 (27.4)	66892 (60.6)	—	—	44403 (62.3)	—	21.3
IUTPY80	727	—	—	49351 (26.9)	66892 (60.6)	—	—	44403 (59.0)	—	22.5
IUTP85	715	63670 (21.1)	62220 (35.5)	49348 (28.8)	66999 (63.5)	—	—	44403 (61.7)	—	21.5
IUTPP75	789	63700 (12.4)	62123 (28.9)	—	64758 (59.7)	64410 (90)	—	44404 (41.2)	—	26.1
IUTPP80	805	63670 (13.3)	62530 (32.2)	—	66892 (63.2)	64410 (90)	—	44404 (40.7)	—	26.4
IUTPP85	821	63670 (14.2)	62220 (35.5)	—	66999 (66.2)	64410 (90)	—	44404 (40.3)	—	26.7
IUTPP90	837	63670 (15.0)	62220 (37.1)	—	66991 (69.2)	64410 (90)	—	44404 (39.8)	—	27.0
IMVP85	899	—	—	28409 (41.6)	—	—	—	—	—	24.0
IUTMVPP75	827	—	44278 (*)	44284 (*)	—	44276 (*)	44277 (*)	44404 (25.2)	—	18.4
IUTMVPPY75	799	—	44278 (*)	44284 (*)	—	44276 (*)	44277 (*)	44404 (25.5)	—	18.4
IUTMVPP85	880	—	44279 (*)	44285 (*)	—	44276 (*)	44277 (*)	44404 (24.0)	—	18.3
IUTMVPPY85	847	—	44279 (*)	44285 (*)	—	44276 (*)	44277 (*)	44404 (24.1)	—	18.3
IUTMVPP95	1006	—	44280 (*)	—	—	44276 (*)	44277 (*)	44404 (22.8)	—	18.8
IUTMVPPY95	964	—	44280 (*)	—	—	44276 (*)	44277 (*)	44404 (23.5)	—	18.8
IUHW90	1048	—	62220 (37.8)	—	—	—	—	44404 (33.7)	62430 (24.8)	33.0
IUHW10	1106	—	62124 (45.8)	—	—	—	—	44404 (33.1)	62430 (24.8)	33.6
—	—	UltraMount to UniMount Conversion Kit 27170 (94.0)								Varies

* This part number is currently not available for purchase, thus finalized weights have not been established. Once weights are established and product is available, finalized weights will be published.

NOTE: The addition of accessories to a snowplow or vehicle will require additional ballast above any amount published in this guide in order to maintain FMVSS compliance. Completed vehicle with additional accessories shall not exceed GVWR or GAWR.

NOTE: An abbreviation key is on page 2.

Mount Information							
Mount	Weight (lb)	X (in)	Y (in)	Mount	Weight (lb)	X (in)	Y (in)
Suburbanite™ Mounts							
1203	34.0	27.0	6.0	2313	30.0	27.0	5.0
1213-1	23.0	26.0	6.0	3713-1	20.0	26.0	5.0
1223	40.0	28.0	7.0	3723	35.0	21.4	5.0
1233	34.0	32.0	7.1	31303	43.0	27.9	4.8
1503	26.0	27.0	6.0	31543	20.0	28.5	7.1
1523	26.0	30.0	6.0	32323	36.0	30.0	7.3
1533-1	31.0	26.0	5.0	33903	45.0	31.0	7.8
2303	41.0	29.0	6.0	42021	37.0	29.0	8.0
UniMount® and UltraMount® Mounts							
1369	80.0	32.9	8.3	63760	40.0	30.0	8.0
1379	83.0	32.9	8.3	63883-2	47.0	37.0	6.9
3249	65.0	30.4	9.8	63900	87.0	29.6	12.5
3919	47.0	30.1	8.5	64110	115.0	38.0	10.0
33109	110.0	38.0	7.0	64500	33.0	32.5	8.9
33259	43.0	33.5	10.8	67810	44.0	35.1	8.7
33559	115.0	38.0	10.0	67865	41.0	31.3	7.6
33929	39.0	32.5	8.1	67960-1	34.0	29.1	7.6
30999	40.0	33.5	8	67980	51.0	35.0	8.5
62275	Varies			67981-2	54.0	32.4	11.4
63710-1	87.0	27.8	5.7	67982	69.0	30.4	9.0

NOTE: See next page for variable definitions.

DIMENSIONAL DIAGRAM

Variables:

X = Distance from center of front axle to receiver pin

Y = Distance from receiver pin to CG of mount.

Z = Distance from receiver pin to CG of snowplow.

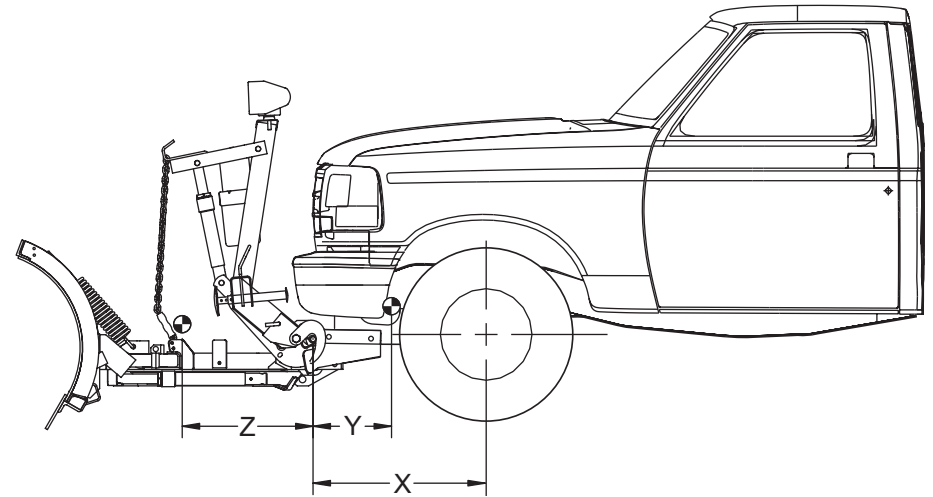

Example: Weight that one would use if they had an IUTP75 with the poly deflector and a 1/2" cutting edge.

The weight of the plow alone with no accessories would be 682 lb with its center of gravity 20.8 in from the coupling point. To add the weight of the accessories, look in the row with the IUTP75 blade to find the effective poly deflector weight of 19.2 lb and the effective cutting edge weight of 25.8 lb.

The total weight of the blade and accessories will be:

$$\begin{array}{r}
 682.0 \\
 19.2 \\
 + 25.8 \\
 \hline
 727.0
 \end{array}$$

with its center of gravity still at 20.8 in from the coupling point

ALWAYS comply with the vehicle manufacturer's stated gross vehicle and axle weight ratings (found on

the driver-side door jamb of the vehicle) and front and rear weight distribution ratio with the snowplow installed. In some cases, rear ballast may be required to achieve these requirements.

Available vehicle capacities for aftermarket equipment and components can be determined by using the above information along with information provided by the vehicle manufacturer's Body Builder Guides. Follow all requirements and recommendations as stated by vehicle manufacturer.

NOTE: An abbreviation key is on page 2.

VEHICLE AND PLOW APPLICATION INQUIRY SHEET



Western Products
7777 North 73rd Street
Milwaukee, WI 53223

Telephone (414) 354-2310
Fax (414) 354-6664

DISTRIBUTOR		TEL
		FAX

CUSTOMER		
VIN		DATE BUILT

SELECT MOUNT TYPE	<input type="checkbox"/> UniMount [®]	<input type="checkbox"/> UltraMount [®]	<input type="checkbox"/> Conversion Kit
	<input type="checkbox"/> Suburbanite [™]		

VEHICLE INFORMATION

YEAR			
MAKE			
MODEL			
DRIVE TRAIN	<input type="checkbox"/> 4x2 (over 10,000 lb. GVW only)	<input type="checkbox"/> 4x4	<input type="checkbox"/> ALL WHEEL <input type="text"/> OTHER
DRW (Dual Rear Wheels)	<input type="checkbox"/> YES	<input type="checkbox"/> NO	
BODY STYLE	<input type="checkbox"/> REG CAB	<input type="checkbox"/> EXT CAB	<input type="text"/> OTHER
BOX OPTION (S)	<input type="checkbox"/> DUMP BOX	<input type="checkbox"/> STAKE BED	<input type="text"/> OTHER
ENGINE TYPE			
GFAWR			
GRAWR			
GVWR			

HORIZONTAL DISTANCE DESCRIPTION

L31	DRIVERS hip point; in MIDDLE position, to Centerline of FRONT axle	(in.)
L101	Between axles (Wheelbase)	(in.)
L104	Middle of FRONT bumper to centerline of FRONT axle	(in.)
	Middle of ballast location to centerline of REAR axle	(in.)

VEHICLE WEIGHT (TRUCK MUST BE WEIGHED COMPLETE AND EMPTY (-) OCCUPANTS, PLOW & MOUNT)

FRONT (lb.)	REAR (lb.)

FUEL TANKS (ONLY NEEDED IF WEIGHED VEHICLE NOT FULLY FUELED)

	LEVEL (see below)	CAPACITY (gal.)	LOCATION FROM AXLE TO CENTER OF TANK(in.)
FRONT OF AXLE			
REAR OF AXLE			

FUEL LEVEL (EMPTY = 0, HALF = 1/2, FULL = 1)

THIS FORM *MUST* BE COMPLETED IN ITS ENTIRETY. ANY FORMS CONTAINING INCOMPLETE INFORMATION *WILL NOT BE CONSIDERED*. PLEASE RETURN VIA FAX (414) 354-6664.

Western Products or the vehicle manufacturer may require or recommend optional equipment for snow removal.
See the WESTERN[®] Selection List for additional product information.

UltraMount® SYSTEM TO UniMount® SYSTEM CONVERSION KIT (PN 27170)

⚠ WARNING

Conversion kit use is limited to vehicles up to 19,500 lb GVWR.

⚠ WARNING

Do not exceed GVWR or GAWR, including blade and ballast. The rating label is found on the driver-side vehicle door cornerpost.

This easy to use UltraMount system to UniMount system conversion kit enables you to attach a UniMount plow to a vehicle equipped with an UltraMount mount.

Simply remove the receivers from your UltraMount system mount, and pin the conversion plate in place. This accessory is perfect for customers with multiple snowplows, providing their fleet with versatility while changing to the UltraMount system.

This new kit is also ideal for transferring an old UniMount plow to a new truck. As new trucks are released, we will develop only new UltraMount mounts for these plow applications. This will allow the customer to transfer an existing UniMount plow to the late model vehicle. In addition, when customers are ready to replace their old UniMount plow, the truck will already have the mount and wiring for an UltraMount plow.

TO QUALIFY THE VEHICLE AND DETERMINE BALLAST, YOU MUST FILL OUT THE VEHICLE AND PLOW APPLICATION INQUIRY SHEET.

NOTE: When ballast is required, it should be secured behind the rear wheels in a manner which prevents it from sliding during normal driving. Western Products offers an options ballast retainer kit (PN 62849) for this purpose.

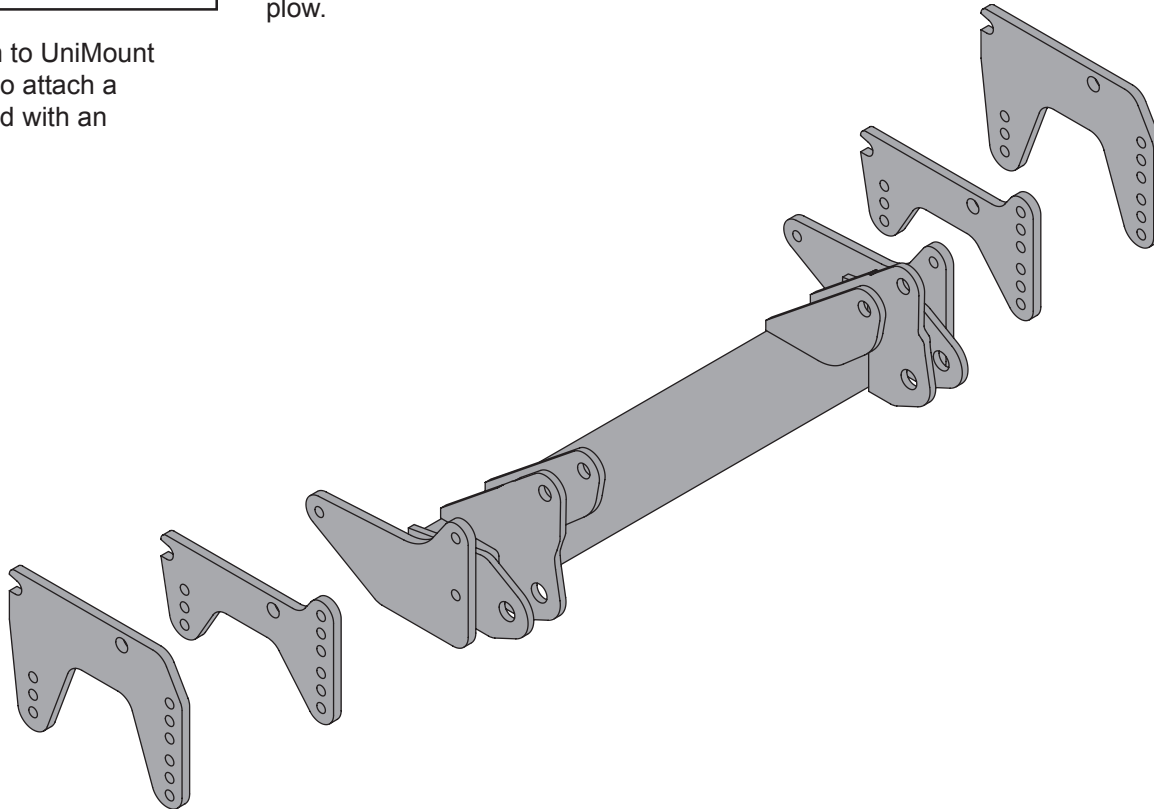

Notes:



WESTERN PRODUCTS
P.O. BOX 245038
MILWAUKEE, WI 53224-9538

 A DIVISION OF DOUGLAS DYNAMICS, L.L.C.

Western Products reserves the right under its product improvement policy to change construction or design details and furnish equipment when so altered without reference to illustrations or specifications used. Western Products or the vehicle manufacturer may require or recommend optional equipment for snow removal. Do not exceed vehicle ratings with a snowplow. Western Products offers a limited warranty for all snowplows and accessories. See separately printed page for this important information. The following are registered (®) or unregistered (™) trademarks of Douglas Dynamics, L.L.C.: MIDWEIGHT™, MVP®, MVP PLUS™, POLY PRO-PLOW®, PRO-PLOW®, PRO PLUS®, Suburbanite™, UltraMount®, UniMount®, WESTERN®.

Printed in U.S.A.