



# 1996 & Prior

MODEL YEAR VEHICLES

## SELECTION LIST

### Isolation Module System Snowplows



Lit. No. 64300  
June 1, 2006  
Revision 04

This document supersedes all editions with an earlier date.

## TABLE OF CONTENTS

<b>About the <i>Selection List</i> .....</b>	<b>3</b>	<b>Toyota Attachment Kits .....</b>	<b>26</b>
<b>Selection Example .....</b>	<b>4</b>	<b>Headlamp Reference Guide .....</b>	<b>27</b>
<b>Chevy/GMC Attachment Kits .....</b>	<b>5</b>	<b>Weight and Dimensional Charts .....</b>	<b>28</b>
<b>Dodge Attachment Kits .....</b>	<b>15</b>	<b>Dimensional Diagram .....</b>	<b>29</b>
<b>Ford Attachment Kits .....</b>	<b>18</b>	<b>Ballast Inquiry Sheet .....</b>	<b>30</b>
<b>International Attachment Kits .....</b>	<b>25</b>	<b>UltraMount® System to UniMount® System Conversion Kit .....</b>	<b>31</b>

ABBREVIATION KEY			
---	No Application	NTEA	National Truck Equipment Association
4WS	Four Wheel Steering	OEM	Original Equipment Manufacturer
4x2	Two Wheel Drive	OHC	Overhead Cam
4x4	Four Wheel Drive	PN	Part Number
A,Q&L	A-Frame, Quadrant & Lift Frame	RGAWR	Rear Gross Axle Weight Rating
AWD	All Wheel Drive	SL	Selection List
CG	Center of Gravity	SU-2DR	Two Door Sport/Utility Vehicle
Chassis	Chassis Cab or Cab Chassis	SU-4DR	Four Door Sport/Utility Vehicle
DIA	Diameter	SUB	Suburbanite™ Snowplow
DRW	Dual Rear Wheels	UHW	UniMount® Heavy Weight Snowplow
Ext Cab	Extended Cab Vehicle	UTM	UltraMount® MIDWEIGHT™ Snowplow
FFV	Flex Fuel Vehicle	UTMY	UltraMount MIDWEIGHT Poly Snowplow
FGAWR	Front Gross Axle Weight Rating	UTMVP	UltraMount MVP® Snowplow
FMVSS	Federal Motor Vehicle Safety Standards	UTMVPP	UltraMount MVP PLUS Snowplow
GVWR	Gross Vehicle Weight Rating	UTMVPPY	UltraMount Poly MVP PLUS Snowplow
HD	Heavy Duty	UTP	UltraMount PRO-PLOW® Snowplow
HO	High Output	UTPP	UltraMount PRO PLUS® Snowplow
HYD	Hydraulic	UTPY	UltraMount POLY PRO-PLOW Snowplow
MIN	Minimum	w/	With
MVP	MultiPosition V-Plow	w/o	Without
MVPP	MVP PLUS™ Snowplow		

### **⚠ WARNING**

**New untitled vehicle installation of a snowplow requires National Highway Traffic Safety Administration altered vehicle certification labeling. Installer to verify that selected snowplow and ballast, if required, do not exceed GVWR or GAWR rating label and complies with FMVSS.**

### **⚠ WARNING**

**Do not exceed GVWR or GAWR, including blade and ballast. The rating label is found on the driver-side vehicle door cornerpost.**

## **ABOUT THE SELECTION LIST**

The *Selection List (SL)* is designed to help you determine the appropriate snowplow components for a particular snowplow vehicle application. The information published in this guide is based on Federal Motor Vehicle Safety Standards (FMVSS) and a "representative" snowplow vehicle as defined in this guide. The vehicle includes a combined weight of 300 lb for occupants in the front seat location.

This *SL* is for specific model year vehicles only and is listed on the front cover of this guide. This guide should be saved for future reference. New selection guides will be published for the upcoming model year and so on. The instructions on page 4 explain how to use the *Selection List*.

## **The "Representative Vehicle"**

Knowing that today's snowplow vehicles come in a variety of sizes and configurations (such as wheel base, engine size, and handling packages), Western Products has defined a "representative vehicle" that contains the options most likely to appear on a typical snowplow application. The "representative vehicle" includes the following options:

- 4X4 Drivetrain (unless noted)
- Spare Tire & Wheel
- Automatic Transmission
- Rear Bumper
- Air Conditioning
- Full Fluids

---

**NOTE: If the vehicle in question does not match a vehicle listing in the *Selection List*, or has options that differ from the "Representative Vehicle" as defined earlier, the ballast inquiry sheet must be filled out and submitted in order to determine plow availability and correct ballast amounts to maintain FMVSS compliance. Completed vehicle at no time shall exceed GVWR or GAWR.**

---

## **Snowplow Product**

Snowplows are considered motor vehicle equipment. The installer is ultimately responsible for determining and correctly labeling the vehicle with the addition of snowplow selection. No product selected and installed shall render inoperative the vehicle's safety compliance.

## **Product Changes**

All information is as accurate as we can determine but is subject to revision with additional or more complete information. Western Products reserves the right under its product improvement policy to change construction or design details and furnish equipment when so altered without reference to illustrations or specifications used. Western Products or the vehicle manufacturer may require or recommend optional equipment for snow removal.

## **Ballast**

When ballast is required it must be secured behind the rear wheels in a manner which prevents it from sliding during normal driving. Ballast shall not exceed 1000 lb.

Western Products offers an optional ballast retainer kit (62849) for this purpose.

# HOW TO USE THE SELECTION LIST

## Selection Example:

### Acme Motors 15000 VX with UltraMount® System

- Go to the section for the appropriate manufacturer.
- Go to the subsection for the desired snowplow:
  - **Section 1:** Suburbanite™ & MIDWEIGHT™ snowplows
  - **Section 2:** PRO-PLOW®, PRO PLUS® & Heavy Weight snowplows)
  - **Section 3:** MVP® & MVP PLUS™ snowplows)
- Starting at the left-most column, find the **model**, **year** and appropriate configuration for the vehicle. In this case, 4X4, 1996 model year, single rear wheels.

- Locate the **harness kit** part number for this vehicle: 8438. See Headlamp Reference Guide in the back of the Selection List for more information.
- Locate the **mount** for this vehicle: n/a for Suburbanite™ system or 67865 for UltraMount® system. Refer to any footnotes concerning conditions or requirements. For this example the UltraMount system is selected and has three footnotes: 1, 5 and 18.
- Locate the acceptable **blades** at the top of the table. Three short dashes (—) indicates an invalid application. A question mark (?) indicates a ballast inquiry sheet must be completed.

- For this example, choose the 7'-6" Steel MIDWEIGHT blade. A ballast inquiry sheet must be completed to determine the appropriate amount of ballast.
- To order components for a complete snowplow package, read down from the top of the selected blade column for appropriate part numbers. Be sure to select *one* control, either joystick or hand-held. For this example, the part numbers would be:

- 64340 (blade assembly)
- 64336 (A, Q & L assembly Box 1)
- 67992 (A, Q & L assembly Box 2)
- 64620 (hydraulic kit)
- 28800 (light kit)
- 56369 or 56462 (control)
- 8438 (harness kit, from Step 4)
- 67865 (mount, from Step 5 – *must match blade*)

1996 & Prior Acme Motors ← (1)

Section 1 of 3 ← (2)  
Suburbanite™ & MIDWEIGHT™ blades

Model	Year	Body Style	DRW	Box Option	Engine Type	Min F G A W R	Min R G A W R	Min G V W R	Harness Kit	Personal Plow system		UltraMount® system						
										Mount Kit	Notes	Mount Kit	Notes					
15000 RS	4x4	1994	All	No	All	All	All	All	HB3/HB4 use 8438	n/a	---	---	---	67865	5,18	?	?	
15000 RS	4x4	1995	All	No	All	All	All	All		n/a	---	---	---	---	67865	5,18	?	?
15000 RS	4x4	1996	All	No	All	All	All	All		n/a	---	---	---	---	67865	5,18	?	?

Suburbanite™	
6'-8" POLY	7'-4" POLY
SUB68	SUB74
Blade Assembly 27546	Blade Assembly 27548
AQ&L Assembly Box 1 27550	
AQ&L Assembly Box 2 n/a	
Hydraulic Kit 27516	
Light Kit 64100	
Choose a Joystick Control or Hand-Held Control 56369	
56462	

MIDWEIGHT™	
7'-6" STEEL	7'-6" POLY
IUTH75	IUTHY75
Blade Assembly 64340	Blade Assembly 64330
AQ&L Assembly Box 1 64336	
AQ&L Assembly Box 2 67992	
Hydraulic Kit 64620	
Light Kit 28800	
Choose a Joystick Control or Hand-Held Control 56369	
56462	

- Notes:**
- Ballast amounts are based on a "Representative Vehicle," defined in the vehicle selection guide instructions, and must be modified for all other configurations for axle and GVWR compliance.
  - Recommended snowplow prep package whenever available.
  - Requires bumper notching.

- Recommended Z85 suspension.
- All New Style Only (2nd # in model # is 5 not 0) example: K15903. Refer to label in glove box for model number.
- These Snowplows Are For Personal/Homeowner Use Only.

# 1996 & Prior Chevy/GMC

## Section 1 Suburbanite™ & MIDWEIGHT™ Blades

	
<b>Suburbanite™</b>	
6'-8" POLY	7'-4" POLY
<b>SUB68</b>	<b>SUB74</b>
27546	27548
27550	
n/a	
27516	
64100	
56369	
56462	

	
<b>MIDWEIGHT™</b>	
7'-6" STEEL	7'-6" POLY
<b>IUTM75</b>	<b>IUTW75</b>
64340	64330
64336	
67992	
64620	
28800	
56369	
56462	

Plow  
Blade Assembly  
AQ&L Assembly Box 1  
AQ&L Assembly Box 2  
Hydraulic Kit  
Light Kit  
Choose a Joystick Control  
or Hand-Held Control

Model	Year	Body Style	DRW	Box Option	Engine Type	Min F G A W R	Min R G A W R	Min G V W R	Harness Kit	Personal Plow system		Ballast Guidelines, lbs (1)		UltraMount® system		Ballast Guidelines, lbs (1)		
										Mount Kit	Notes			Mount Kit	Notes			
S-10/SONOMA	4x4	1995	All	No	All	All	All	All	2E use 8439 & 27968 or HB3/HB4 use 8438	1503	8,16	?	?	n/a	---	---	---	
S-10/SONOMA	4x4	1996	All	No	All	All	All	All		1503	8,16	?	?	n/a	---	---	---	
BLAZER/JIMMY	4x4	1995	All	No	All	All	All	All		1503	8,16	?	?	n/a	---	---	---	
BLAZER/JIMMY	4x4	1996	All	No	All	All	All	All	2B use 8439 or LF/UF n/a or 1A/2A use 8436 & 26641	1503	8,16	?	?	n/a	---	---	---	
BLAZER/JIMMY (FULL SIZE)	4x4	1981	All	No	All	All	All	All		n/a	---	---	---	63900	---	?	?	
BLAZER/JIMMY (FULL SIZE)	4x4	1982	All	No	All	All	All	All		n/a	---	---	---	63900	---	?	?	
BLAZER/JIMMY (FULL SIZE)	4x4	1983	All	No	All	All	All	All		n/a	---	---	---	63900	---	?	?	
BLAZER/JIMMY (FULL SIZE)	4x4	1984	All	No	All	All	All	All		n/a	---	---	---	63900	---	?	?	
BLAZER/JIMMY (FULL SIZE)	4x4	1985	All	No	All	All	All	All		n/a	---	---	---	63900	---	?	?	
BLAZER/JIMMY (FULL SIZE)	4x4	1986	All	No	All	All	All	All		n/a	---	---	---	63900	---	?	?	
BLAZER/JIMMY (FULL SIZE)	4x4	1987	All	No	All	All	All	All		n/a	---	---	---	63900	---	?	?	
BLAZER/JIMMY (FULL SIZE)	4x4	1988	All	No	All	All	All	All		n/a	---	---	---	63900	---	?	?	
BLAZER/JIMMY (FULL SIZE)	4x4	1989	All	No	All	All	All	All		n/a	---	---	---	63900	---	?	?	
BLAZER/JIMMY (FULL SIZE)	4x4	1990	All	No	All	All	All	All		n/a	---	---	---	63900	---	?	?	
BLAZER/JIMMY (FULL SIZE)	4x4	1991	All	No	All	All	All	All		n/a	---	---	---	63900	---	?	?	
BLAZER (FULL SIZE)	4x4	1992	All	No	All	All	All	All		2B use 8439 or HB3/HB4 use 8438	n/a	---	---	---	67865	5,18	?	?
BLAZER (FULL SIZE)	4x4	1993	All	No	All	All	All	All			n/a	---	---	---	67865	5,18	?	?
BLAZER (FULL SIZE)	4x4	1994	All	No	All	All	All	All	2B use 8439 or 1A/2A use 8436 & 26641	n/a	---	---	---	67865	5,18	?	?	
1/2 TON SUBURBAN (1500)	4x4	1973	All	No	All	All	All	All		n/a	---	---	---	63900	---	?	?	
1/2 TON SUBURBAN (1500)	4x4	1974	All	No	All	All	All	All		n/a	---	---	---	63900	---	?	?	
1/2 TON SUBURBAN (1500)	4x4	1975	All	No	All	All	All	All		n/a	---	---	---	63900	---	?	?	
1/2 TON SUBURBAN (1500)	4x4	1976	All	No	All	All	All	All		n/a	---	---	---	63900	---	?	?	
1/2 TON SUBURBAN (1500)	4x4	1977	All	No	All	All	All	All		n/a	---	---	---	63900	---	?	?	
1/2 TON SUBURBAN (1500)	4x4	1978	All	No	All	All	All	All		n/a	---	---	---	63900	---	?	?	
1/2 TON SUBURBAN (1500)	4x4	1979	All	No	All	All	All	All		n/a	---	---	---	63900	---	?	?	
1/2 TON SUBURBAN (1500)	4x4	1980	All	No	All	All	All	All		n/a	---	---	---	63900	---	?	?	
1/2 TON SUBURBAN (1500)	4x4	1981	All	No	All	All	All	All		n/a	---	---	---	63900	---	?	?	
1/2 TON SUBURBAN (1500)	4x4	1982	All	No	All	All	All	All		n/a	---	---	---	63900	---	?	?	
1/2 TON SUBURBAN (1500)	4x4	1983	All	No	All	All	All	All		n/a	---	---	---	63900	---	?	?	
1/2 TON SUBURBAN (1500)	4x4	1984	All	No	All	All	All	All		n/a	---	---	---	63900	---	?	?	
1/2 TON SUBURBAN (1500)	4x4	1985	All	No	All	All	All	All		n/a	---	---	---	63900	---	?	?	
1/2 TON SUBURBAN (1500)	4x4	1986	All	No	All	All	All	All		n/a	---	---	---	63900	---	?	?	
1/2 TON SUBURBAN (1500)	4x4	1987	All	No	All	All	All	All		n/a	---	---	---	63900	---	?	?	

- Notes:**
- Ballast amounts are based on a "Representative Vehicle," defined in the vehicle selection guide instructions, and must be modified for all other configurations for axle and GVWR compliance.
  - Classic Style Only (2nd # in model # is 0 not 5) example: K10903. Refer to label in glove box for model number.

- These Snowplows Are For Personal/Homeowner Use Only.
- Not intended for use with High Rider or ZR2 style trucks.
- Recommended F60 suspension or snowplow prep package.

# 1996 & Prior Chevy/GMC

## Section 1 Suburbanite™ & MIDWEIGHT™ Blades

 Suburbanite™	
6'-8" POLY SUB68	7'-4" POLY SUB74
Blade Assembly AQ&L Assembly Box 1 AQ&L Assembly Box 2 Hydraulic Kit Light Kit Choose a Joystick Control or Hand-Held Control	
27546 27548	
27550	
n/a	
27516	
64100	
56369	
56462	

 UltraMount™	
MIDWEIGHT™	
7'-6" STEEL IUTM75	7'-6" POLY IUTM75
64340 64330	
64336	
67992	
64620	
28800	
56369	
56462	

Model	Year	Body Style	DRW	Box Option	Engine Type	Min F G A W R	Min R G A W R	Min G V W R	Harness Kit	Personal Plow system		Ballast Guidelines, lbs (1)		UltraMount® system		Ballast Guidelines, lbs (1)	
										Mount Kit	Notes			Mount Kit	Notes		
1/2 TON SUBURBAN (1500)	1988	All	No	All	All	All	All	All	2B use 8439 or LF/UF n/a or 1A/2A use 8436 & 26641	n/a	---	---	---	63900	---	?	?
1/2 TON SUBURBAN (1500)	1989	All	No	All	All	All	All	All		n/a	---	---	---	63900	---	?	?
1/2 TON SUBURBAN (1500)	1990	All	No	All	All	All	All	All	2B use 8439 or HB3/HB4 use 8438	n/a	---	---	---	63900	---	?	?
1/2 TON SUBURBAN (1500)	1991	All	No	All	All	All	All	All		n/a	---	---	---	63900	---	?	?
1/2 TON SUBURBAN (1500)	1992	All	No	All	All	All	All	All	2B use 8439 or HB3/HB4 use 8438	n/a	---	---	---	67865	5	?	?
1/2 TON SUBURBAN (1500)	1993	All	No	All	All	All	All	All		n/a	---	---	---	67865	5	?	?
1/2 TON SUBURBAN (1500)	1994	All	No	All	All	All	All	All	2B use 8439 or HB3/HB4 use 8438	n/a	---	---	---	67865	5	?	?
1/2 TON SUBURBAN (1500)	1995	All	No	All	All	All	All	All		n/a	---	---	---	67865	5	?	?
1/2 TON SUBURBAN (1500)	1996	All	No	All	All	All	All	All	2B use 8439 or HB3/HB4 use 8438	n/a	---	---	---	67865	5	?	?
3/4 TON SUBURBAN (2500)	1973	All	No	All	All	All	All	All		n/a	---	---	---	63900	---	?	?
3/4 TON SUBURBAN (2500)	1974	All	No	All	All	All	All	All	2B use 8439 or 1A/2A use 8436 & 26641	n/a	---	---	---	63900	---	?	?
3/4 TON SUBURBAN (2500)	1975	All	No	All	All	All	All	All		n/a	---	---	---	63900	---	?	?
3/4 TON SUBURBAN (2500)	1976	All	No	All	All	All	All	All	2B use 8439 or 1A/2A use 8436 & 26641	n/a	---	---	---	63900	---	?	?
3/4 TON SUBURBAN (2500)	1977	All	No	All	All	All	All	All		n/a	---	---	---	63900	---	?	?
3/4 TON SUBURBAN (2500)	1978	All	No	All	All	All	All	All	2B use 8439 or 1A/2A use 8436 & 26641	n/a	---	---	---	63900	---	?	?
3/4 TON SUBURBAN (2500)	1979	All	No	All	All	All	All	All		n/a	---	---	---	63900	---	?	?
3/4 TON SUBURBAN (2500)	1980	All	No	All	All	All	All	All	2B use 8439 or 1A/2A use 8436 & 26641	n/a	---	---	---	63900	---	?	?
3/4 TON SUBURBAN (2500)	1981	All	No	All	All	All	All	All		n/a	---	---	---	63900	---	?	?
3/4 TON SUBURBAN (2500)	1982	All	No	All	All	All	All	All	2B use 8439 or 1A/2A use 8436 & 26641	n/a	---	---	---	63900	---	?	?
3/4 TON SUBURBAN (2500)	1983	All	No	All	All	All	All	All		n/a	---	---	---	63900	---	?	?
3/4 TON SUBURBAN (2500)	1984	All	No	All	All	All	All	All	2B use 8439 or 1A/2A use 8436 & 26641	n/a	---	---	---	63900	---	?	?
3/4 TON SUBURBAN (2500)	1985	All	No	All	All	All	All	All		n/a	---	---	---	63900	---	?	?
3/4 TON SUBURBAN (2500)	1986	All	No	All	All	All	All	All	2B use 8439 or 1A/2A use 8436 & 26641	n/a	---	---	---	63900	---	?	?
3/4 TON SUBURBAN (2500)	1987	All	No	All	All	All	All	All		n/a	---	---	---	63900	---	?	?
3/4 TON SUBURBAN (2500)	1988	All	No	All	All	All	All	All	2B use 8439 or 1A/2A use 8436 & 26641	n/a	---	---	---	63900	---	?	?
3/4 TON SUBURBAN (2500)	1989	All	No	All	All	All	All	All		n/a	---	---	---	63900	---	?	?
3/4 TON SUBURBAN (2500)	1990	All	No	All	All	All	All	All	2B use 8439 or 1A/2A use 8436 & 26641	n/a	---	---	---	63900	---	?	?
3/4 TON SUBURBAN (2500)	1991	All	No	All	All	All	All	All		n/a	---	---	---	63900	---	?	?

**Notes:**  
 1. Ballast amounts are based on a "Representative Vehicle," defined in the vehicle selection guide instructions, and must be modified for all other configurations for axle and GVWR compliance.  
 5. Classic Style Only (2nd # in model # is 0 not 5) example: K10903. Refer to label in glove box for model number.

# 1996 & Prior Chevy/GMC

## Section 1 Suburbanite™ & MIDWEIGHT™ Blades

	
<b>Suburbanite™</b>	
6'-8" POLY	7'-4" POLY
<b>SUB68</b>	<b>SUB74</b>
Plow Blade Assembly	27546    27548
AQ&L Assembly Box 1	27550
AQ&L Assembly Box 2	n/a
Hydraulic Kit	27516
Light Kit	64100
Choose a Joystick Control	56369
or Hand-Held Control	56462

	
<b>MIDWEIGHT™</b>	
7'-6" STEEL	7'-6" POLY
<b>IUTH75</b>	<b>IUTW75</b>
64340	64330
64336	
67992	
64620	
28800	
56369	
56462	

Model	Year	Body Style	DRW	Box Option	Engine Type	Min F G A W R	Min R G A W R	Min G V W R	Harness Kit	Personal Plow system		Ballast Guidelines, lbs (1)	UltraMount® system		Ballast Guidelines, lbs (1)			
										Mount Kit	Notes		Mount Kit	Notes				
3/4 TON SUBURBAN (2500)	4x4	1992	All	No	All	All	All	All	2B use 8439 or HB3/HB4 use 8438	n/a	---	---	---	67865	5	?	?	
3/4 TON SUBURBAN (2500)	4x4	1993	All	No	All	All	All	All		n/a	---	---	---	67865	5	?	?	
3/4 TON SUBURBAN (2500)	4x4	1994	All	No	All	All	All	All		n/a	---	---	---	67865	5	?	?	
3/4 TON SUBURBAN (2500)	4x4	1995	All	No	All	All	All	All		n/a	---	---	---	67865	5	?	?	
3/4 TON SUBURBAN (2500)	4x4	1996	All	No	All	All	All	All		n/a	---	---	---	67865	5	?	?	
YUKON	4x4	1992	All	No	All	All	All	All		n/a	---	---	---	67865	5,18	?	?	
YUKON	4x4	1993	All	No	All	All	All	All		n/a	---	---	---	67865	5,18	?	?	
YUKON	4x4	1994	All	No	All	All	All	All		n/a	---	---	---	67865	5,18	?	?	
YUKON	4x4	1995	All	No	All	All	All	All		n/a	---	---	---	67865	5,18	?	?	
YUKON	4x4	1996	All	No	All	All	All	All		n/a	---	---	---	67865	5,18	?	?	
TAHOE	4x4	1995	All	No	All	All	All	All		n/a	---	---	---	67865	5,18	?	?	
TAHOE	4x4	1996	All	No	All	All	All	All		n/a	---	---	---	67865	5,18	?	?	
K1500	4x4	1973	All	No	All	All	All	All		2B use 8439 or 1A/2A use 8436 & 26641	n/a	---	---	---	63900	18	?	?
K1500	4x4	1974	All	No	All	All	All	All			n/a	---	---	---	63900	18	?	?
K1500	4x4	1975	All	No	All	All	All	All			n/a	---	---	---	63900	18	?	?
K1500	4x4	1976	All	No	All	All	All	All			n/a	---	---	---	63900	18	?	?
K1500	4x4	1977	All	No	All	All	All	All			n/a	---	---	---	63900	18	?	?
K1500	4x4	1978	All	No	All	All	All	All			n/a	---	---	---	63900	18	?	?
K1500	4x4	1979	All	No	All	All	All	All	n/a		---	---	---	63900	18	?	?	
K1500	4x4	1980	All	No	All	All	All	All	n/a		---	---	---	63900	18	?	?	
K1500	4x4	1981	All	No	All	All	All	All	n/a		---	---	---	63900	18	?	?	
K1500	4x4	1982	All	No	All	All	All	All	n/a		---	---	---	63900	18	?	?	
K1500	4x4	1983	All	No	All	All	All	All	n/a		---	---	---	63900	18	?	?	
K1500	4x4	1984	All	No	All	All	All	All	n/a		---	---	---	63900	18	?	?	
K1500	4x4	1985	All	No	All	All	All	All	n/a		---	---	---	63900	18	?	?	
K1500	4x4	1986	All	No	All	All	All	All	n/a		---	---	---	63900	18	?	?	

**Notes:**

- Ballast amounts are based on a "Representative Vehicle," defined in the vehicle selection guide instructions, and must be modified for all other configurations for axle and GVWR compliance.
- Classic Style Only (2nd # in model # is 0 not 5) example: K10903. Refer to label in glove box for model number.
- Recommended F60 suspension or snowplow prep package.

# 1996 & Prior Chevy/GMC

## Section 1 Suburbanite™ & MIDWEIGHT™ Blades

 Suburbanite™	
6'-8" POLY SUB68	7'-4" POLY SUB74
Plow Blade Assembly AQ&L Assembly Box 1 AQ&L Assembly Box 2 Hydraulic Kit Light Kit Choose a Joystick Control or Hand-Held Control	
27546	27548
27550	
n/a	
27516	
64100	
56369	
56462	

 UltraMount™	
MIDWEIGHT™	
7'-6" STEEL IUTM75	7'-6" POLY IUTW75
64340	64330
64336	
67992	
64620	
28800	
56369	
56462	

Model	Year	Body Style	DRW	Box Option	Engine Type	Min F G A W R	Min R G A W R	Min G V W R	Harness Kit	Personal Plow system		Ballast Guidelines, lbs (1)	UltraMount® system		Ballast Guidelines, lbs (1)		
										Mount Kit	Notes		Mount Kit	Notes			
K1500	4x4	1987	All	No	All	All	All	All	2B use 8439 or HB3/HB4 use 8438 or LF/UF n/a	n/a	---	---	---	63900	18	?	?
K1500	4x4	1988	All	No	All	All	All	All		n/a	---	---	---	67865	5,18	?	?
K1500	4x4	1989	All	No	All	All	All	All		n/a	---	---	---	67865	5,18	?	?
K1500	4x4	1990	All	No	All	All	All	All		n/a	---	---	---	67865	5,18	?	?
K1500	4x4	1991	All	No	All	All	All	All		n/a	---	---	---	67865	5,18	?	?
K1500	4x4	1992	All	No	All	All	All	All		n/a	---	---	---	67865	5,18	?	?
K1500	4x4	1993	All	No	All	All	All	All		n/a	---	---	---	67865	5,18	?	?
K1500	4x4	1994	All	No	All	All	All	All		n/a	---	---	---	67865	5,18	?	?
K1500	4x4	1995	All	No	All	All	All	All		n/a	---	---	---	67865	5,18	?	?
K1500	4x4	1996	All	No	All	All	All	All		n/a	---	---	---	67865	5,18	?	?
K2500	4x4	1973	All	No	All	All	All	All	2B use 8439 or 1A/2A use 8436 & 26641	n/a	---	---	---	63900	18	?	?
K2500	4x4	1974	All	No	All	All	All	All		n/a	---	---	---	63900	18	?	?
K2500	4x4	1975	All	No	All	All	All	All		n/a	---	---	---	63900	18	?	?
K2500	4x4	1976	All	No	All	All	All	All		n/a	---	---	---	63900	18	?	?
K2500	4x4	1977	All	No	All	All	All	All		n/a	---	---	---	63900	18	?	?
K2500	4x4	1978	All	No	All	All	All	All		n/a	---	---	---	63900	18	?	?
K2500	4x4	1979	All	No	All	All	All	All		n/a	---	---	---	63900	18	?	?
K2500	4x4	1980	All	No	All	All	All	All		n/a	---	---	---	63900	18	?	?
K2500	4x4	1981	All	No	All	All	All	All		n/a	---	---	---	63900	18	?	?
K2500	4x4	1982	All	No	All	All	All	All		n/a	---	---	---	63900	18	?	?
K2500	4x4	1983	All	No	All	All	All	All	2B use 8439 or HB3/HB4 use 8438 or LF/UF n/a	n/a	---	---	---	63900	18	?	?
K2500	4x4	1984	All	No	All	All	All	All		n/a	---	---	---	63900	18	?	?
K2500	4x4	1985	All	No	All	All	All	All		n/a	---	---	---	63900	18	?	?
K2500	4x4	1986	All	No	All	All	All	All		n/a	---	---	---	63900	18	?	?
K2500	4x4	1987	All	No	All	All	All	All		n/a	---	---	---	63900	18	?	?

- Notes:**
- Ballast amounts are based on a "Representative Vehicle," defined in the vehicle selection guide instructions, and must be modified for all other configurations for axle and GVWR compliance.
  - Classic Style Only (2nd # in model # is 0 not 5) example: K10903. Refer to label in glove box for model number.
  - Recommended F60 suspension or snowplow prep package.



# 1996 & Prior Chevy/GMC

## Section 1 Suburbanite™ & MIDWEIGHT™ Blades

	
<b>Suburbanite™</b>	
6'-8" POLY	7'-4" POLY
<b>SUB68</b>	<b>SUB74</b>
Plow Blade Assembly	27546 27548
AQ&L Assembly Box 1	27550
AQ&L Assembly Box 2	n/a
Hydraulic Kit	27516
Light Kit	64100
Choose a Joystick Control	56369
or Hand-Held Control	56462

	
<b>MIDWEIGHT™</b>	
7'-6" STEEL	7'-6" POLY
<b>IUTM75</b>	<b>IUTW75</b>
64340	64330
64336	
67992	
64620	
28800	
56369	
56462	

Model	Year	Body Style	DRW	Box Option	Engine Type	Min F G A W R	Min R G A W R	Min G V W R	Harness Kit	Personal Plow system		Ballast Guidelines, lbs (1)		UltraMount® system		Ballast Guidelines, lbs (1)	
										Mount Kit	Notes			Mount Kit	Notes		
K2500 LIGHT DUTY	4x4	1988	All	No	All	All	All	7200	2B use 8439 or HB3/HB4 use 8438 or LF/UF n/a	n/a	---	---	---	67865	5,18	?	?
K2500 LIGHT DUTY	4x4	1989	All	No	All	All	All	7200		n/a	---	---	---	67865	5,18	?	?
K2500 LIGHT DUTY	4x4	1990	All	No	All	All	All	7200		n/a	---	---	---	67865	5,18	?	?
K2500 LIGHT DUTY	4x4	1991	All	No	All	All	All	7200		n/a	---	---	---	67865	5,18	?	?
K2500 LIGHT DUTY	4x4	1992	All	No	All	All	All	7200		n/a	---	---	---	67865	5,18	?	?
K2500 LIGHT DUTY	4x4	1993	All	No	All	All	All	7200		n/a	---	---	---	67865	5,18	?	?
K2500 LIGHT DUTY	4x4	1994	All	No	All	All	All	7200		n/a	---	---	---	67865	5,18	?	?
K2500 LIGHT DUTY	4x4	1995	All	No	All	All	All	7200		n/a	---	---	---	67865	5,18	?	?
K2500 HEAVY DUTY	4x4	1988	All	No	All	All	All	8600		n/a	---	---	---	67865	5,18	?	?
K2500 HEAVY DUTY	4x4	1989	All	No	All	All	All	8600		n/a	---	---	---	67865	5,18	?	?
K2500 HEAVY DUTY	4x4	1990	All	No	All	All	All	8600		n/a	---	---	---	67865	5,18	?	?
K2500 HEAVY DUTY	4x4	1991	All	No	All	All	All	8600		n/a	---	---	---	67865	5,18	?	?
K2500 HEAVY DUTY	4x4	1992	All	No	All	All	All	8600		n/a	---	---	---	67865	5,18	?	?
K2500 HEAVY DUTY	4x4	1993	All	No	All	All	All	8600		n/a	---	---	---	67865	5,18	?	?
K2500 HEAVY DUTY	4x4	1994	All	No	All	All	All	8600		n/a	---	---	---	67865	5,18	?	?
K2500 HEAVY DUTY	4x4	1995	All	No	All	All	All	8600		n/a	---	---	---	67865	5,18	?	?
K2500 HEAVY DUTY	4x4	1996	All	No	All	All	All	8600		n/a	---	---	---	67865	5,18	?	?

- Notes:**
- Ballast amounts are based on a "Representative Vehicle," defined in the vehicle selection guide instructions, and must be modified for all other configurations for axle and GVWR compliance.
  - Classic Style Only (2nd # in model # is 0 not 5) example: K10903. Refer to label in glove box for model number.
  - Recommended F60 suspension or snowplow prep package.

# 1996 & Prior Chevy/GMC

## Section 2 PRO-PLOW®, PRO PLUS® & Heavy Weight Blades

PRO-PLOW®					PRO PLUS®			
7'-6" STEEL	7'-6" POLY	8'-0" STEEL	8'-0" POLY	8'-6" STEEL	7'-6" STEEL	8'-0" STEEL	8'-6" STEEL	9'-0" STEEL
IUTP75	IUTPY75	IUTP80	IUTPY80	IUTP85	IUTPP75	IUTPP80	IUTPP85	IUTPP90
60381	62400	60390	62450	60308	64750	66980	66974	66901
67950					66490			
64588					64999			
28800					56369			
56369					56462			

Heavy Weight	
9'-0" STEEL	10'-0" STEEL
IUHW90	IUHW10
62301	62302
62298-1	
62299-1	
64400	
28800	
56369	
56462	

Plow  
Blade Assembly  
AQ&L Assembly Box 1  
AQ&L Assembly Box 2  
Hydraulic Kit  
Light Kit  
Choose a Joystick Control  
or Hand-Held Control

Model	Year	Body Style	DRW	Box Option	Engine Type	Min F G A W R	Min R G A W R	Min G V W R	Harness Kit	UltraMount® system		Ballast Guidelines, lbs (1)																UniMount® system		Ballast Guidelines, lbs (1)	
										Mount Kit	Notes	Mount Kit	Notes	Mount Kit	Notes	Mount Kit	Notes	Mount Kit	Notes	Mount Kit	Notes	Mount Kit	Notes	Mount Kit	Notes						
BLAZER/JIMMY (FULL SIZE)	4x4	1981	All	No	All	All	All	All		63900	---	?	?	---	---	---	---	---	---	---	---	---	---	---	---	---	n/a	---	---	---	
BLAZER/JIMMY (FULL SIZE)	4x4	1982	All	No	All	All	All	All		63900	---	?	?	---	---	---	---	---	---	---	---	---	---	---	---	---	n/a	---	---	---	
BLAZER/JIMMY (FULL SIZE)	4x4	1983	All	No	All	All	All	All		63900	---	?	?	---	---	---	---	---	---	---	---	---	---	---	---	---	n/a	---	---	---	
BLAZER/JIMMY (FULL SIZE)	4x4	1984	All	No	All	All	All	All		63900	---	?	?	---	---	---	---	---	---	---	---	---	---	---	---	---	n/a	---	---	---	
BLAZER/JIMMY (FULL SIZE)	4x4	1985	All	No	All	All	All	All		63900	---	?	?	---	---	---	---	---	---	---	---	---	---	---	---	---	n/a	---	---	---	
BLAZER/JIMMY (FULL SIZE)	4x4	1986	All	No	All	All	All	All		63900	---	?	?	---	---	---	---	---	---	---	---	---	---	---	---	---	n/a	---	---	---	
BLAZER/JIMMY (FULL SIZE)	4x4	1987	All	No	All	All	All	All		63900	---	?	?	---	---	---	---	---	---	---	---	---	---	---	---	---	n/a	---	---	---	
BLAZER/JIMMY (FULL SIZE)	4x4	1988	All	No	All	All	All	All		63900	---	?	?	---	---	---	---	---	---	---	---	---	---	---	---	---	n/a	---	---	---	
BLAZER/JIMMY (FULL SIZE)	4x4	1989	All	No	All	All	All	All		63900	---	?	?	---	---	---	---	---	---	---	---	---	---	---	---	---	n/a	---	---	---	
BLAZER/JIMMY (FULL SIZE)	4x4	1990	All	No	All	All	All	All		63900	---	?	?	---	---	---	---	---	---	---	---	---	---	---	---	---	n/a	---	---	---	
BLAZER/JIMMY (FULL SIZE)	4x4	1991	All	No	All	All	All	All		63900	---	?	?	---	---	---	---	---	---	---	---	---	---	---	---	---	n/a	---	---	---	
BLAZER (FULL SIZE)	4x4	1992	All	No	All	All	All	All		67865	5,18	?	?	---	---	---	---	---	---	---	---	---	---	---	---	n/a	---	---	---		
BLAZER (FULL SIZE)	4x4	1993	All	No	All	All	All	All		67865	5,18	?	?	---	---	---	---	---	---	---	---	---	---	---	---	n/a	---	---	---		
BLAZER (FULL SIZE)	4x4	1994	All	No	All	All	All	All		67865	5,18	?	?	---	---	---	---	---	---	---	---	---	---	---	---	n/a	---	---	---		
3/4 TON SUBURBAN (2500)	4x4	1992	All	No	All	All	All	All		67865	5	?	?	?	?	?	?	?	?	?	?	?	?	?	?	n/a	---	---	---		
3/4 TON SUBURBAN (2500)	4x4	1993	All	No	All	All	All	All		67865	5	?	?	?	?	?	?	?	?	?	?	?	?	?	?	n/a	---	---	---		
3/4 TON SUBURBAN (2500)	4x4	1994	All	No	All	All	All	All		67865	5	?	?	?	?	?	?	?	?	?	?	?	?	?	?	n/a	---	---	---		
3/4 TON SUBURBAN (2500)	4x4	1995	All	No	All	All	All	All		67865	5	?	?	?	?	?	?	?	?	?	?	?	?	?	?	n/a	---	---	---		
3/4 TON SUBURBAN (2500)	4x4	1996	All	No	All	All	All	All		67865	5	?	?	?	?	?	?	?	?	?	?	?	?	?	?	n/a	---	---	---		
YUKON	4x4	1992	All	No	All	All	All	All		67865	5,18	?	?	?	?	?	?	?	?	?	?	?	?	?	?	n/a	---	---	---		
YUKON	4x4	1993	All	No	All	All	All	All		67865	5,18	?	?	?	?	?	?	?	?	?	?	?	?	?	?	n/a	---	---	---		
YUKON	4x4	1994	All	No	All	All	All	All		67865	5,18	?	?	?	?	?	?	?	?	?	?	?	?	?	?	n/a	---	---	---		
YUKON	4x4	1995	All	No	All	All	All	All		67865	5,18	?	?	?	?	?	?	?	?	?	?	?	?	?	?	n/a	---	---	---		
YUKON	4x4	1996	All	No	All	All	All	All		67865	5,18	?	?	?	?	?	?	?	?	?	?	?	?	?	?	n/a	---	---	---		
TAHOE	4x4	1995	All	No	All	All	All	All		67865	5,18	?	?	?	?	?	?	?	?	?	?	?	?	?	?	n/a	---	---	---		
TAHOE	4x4	1996	All	No	All	All	All	All		67865	5,18	?	?	?	?	?	?	?	?	?	?	?	?	?	?	n/a	---	---	---		

- Notes:**
- Ballast amounts are based on a "Representative Vehicle," defined in the vehicle selection guide instructions, and must be modified for all other configurations for axle and GVWR compliance.
  - Classic Style Only (2nd # in model # is 0 not 5) example: K10903. Refer to label in glove box for model number.
  - Recommended F60 suspension or snowplow prep package.

# 1996 & Prior Chevy/GMC

## Section 2 PRO-PLOW®, PRO PLUS® & Heavy Weight Blades

Plow  
Blade Assembly  
AQ&L Assembly Box 1  
AQ&L Assembly Box 2  
Hydraulic Kit  
Light Kit  
Choose a Joystick Control  
or Hand-Held Control

UltraMount								
PRO-PLOW®					PRO PLUS®			
7'-6" STEEL	7'-6" POLY	8'-0" STEEL	8'-0" POLY	8'-6" STEEL	7'-6" STEEL	8'-0" STEEL	8'-6" STEEL	9'-0" STEEL
IUTP75	IUTPY75	IUTP80	IUTPY80	IUTP85	IUTPP75	IUTPP80	IUTPP85	IUTPP90
60381	62400	60390	62450	60308	64750	66980	66974	66901
67950					66490			
64588					64999			
28800					56369			
56369					56462			

UniMount	
Heavy Weight	
9'-0" STEEL	10'-0" STEEL
IUHW90	IUHW10
62301	62302
62298-1	
62299-1	
64400	
28800	
56369	
56462	

Model	Year	Body Style	DRW	Box Option	Engine Type	Min F G A W R	Min R G A W R	Min S V W R	Harness Kit	UltraMount® system		Ballast Guidelines, lbs (1)								UniMount® system		Ballast Guidelines, lbs (1)		
										Mount Kit	Notes	Mount Kit	Notes	Mount Kit	Notes	Mount Kit	Notes	Mount Kit	Notes					
K1500	4x4	1988	All	No	All	All	All	All		67865	5,18	?	?	?	?	---	---	---	---	---	n/a	---	---	---
K1500	4x4	1989	All	No	All	All	All	All		67865	5,18	?	?	?	?	---	---	---	---	---	n/a	---	---	---
K1500	4x4	1990	All	No	All	All	All	All		67865	5,18	?	?	?	?	---	---	---	---	---	n/a	---	---	---
K1500	4x4	1991	All	No	All	All	All	All		67865	5,18	?	?	?	?	---	---	---	---	---	n/a	---	---	---
K1500	4x4	1992	All	No	All	All	All	All		67865	5,18	?	?	?	?	---	---	---	---	---	n/a	---	---	---
K1500	4x4	1993	All	No	All	All	All	All		67865	5,18	?	?	?	?	---	---	---	---	---	n/a	---	---	---
K1500	4x4	1994	All	No	All	All	All	All		67865	5,18	?	?	?	?	---	---	---	---	---	n/a	---	---	---
K1500	4x4	1995	All	No	All	All	All	All		67865	5,18	?	?	?	?	---	---	---	---	---	n/a	---	---	---
K1500	4x4	1996	All	No	All	All	All	All		67865	5,18	?	?	?	?	---	---	---	---	---	n/a	---	---	---
K2500 LIGHT DUTY	4x4	1988	All	No	All	All	All	All	7200	67865	5,18	?	?	?	?	---	---	---	---	---	n/a	---	---	---
K2500 LIGHT DUTY	4x4	1989	All	No	All	All	All	All	7200	67865	5,18	?	?	?	?	---	---	---	---	---	n/a	---	---	---
K2500 LIGHT DUTY	4x4	1990	All	No	All	All	All	All	7200	67865	5,18	?	?	?	?	---	---	---	---	---	n/a	---	---	---
K2500 LIGHT DUTY	4x4	1991	All	No	All	All	All	All	7200	67865	5,18	?	?	?	?	---	---	---	---	---	n/a	---	---	---
K2500 LIGHT DUTY	4x4	1992	All	No	All	All	All	All	7200	67865	5,18	?	?	?	?	---	---	---	---	---	n/a	---	---	---
K2500 LIGHT DUTY	4x4	1993	All	No	All	All	All	All	7200	67865	5,18	?	?	?	?	---	---	---	---	---	n/a	---	---	---
K2500 LIGHT DUTY	4x4	1994	All	No	All	All	All	All	7200	67865	5,18	?	?	?	?	---	---	---	---	---	n/a	---	---	---
K2500 LIGHT DUTY	4x4	1995	All	No	All	All	All	All	7200	67865	5,18	?	?	?	?	---	---	---	---	---	n/a	---	---	---
K2500 HEAVY DUTY	4x4	1988	All	No	All	All	All	All	8600	67865	5,18	?	?	?	?	---	---	---	---	---	n/a	---	---	---
K2500 HEAVY DUTY	4x4	1989	All	No	All	All	All	All	8600	67865	5,18	?	?	?	?	---	---	---	---	---	n/a	---	---	---
K2500 HEAVY DUTY	4x4	1990	All	No	All	All	All	All	8600	67865	5,18	?	?	?	?	---	---	---	---	---	n/a	---	---	---
K2500 HEAVY DUTY	4x4	1991	All	No	All	All	All	All	8600	67865	5,18	?	?	?	?	---	---	---	---	---	n/a	---	---	---
K2500 HEAVY DUTY	4x4	1992	All	No	All	All	All	All	8600	67865	5,18	?	?	?	?	---	---	---	---	---	n/a	---	---	---
K2500 HEAVY DUTY	4x4	1993	All	No	All	All	All	All	8600	67865	5,18	?	?	?	?	---	---	---	---	---	n/a	---	---	---
K2500 HEAVY DUTY	4x4	1994	All	No	All	All	All	All	8600	67865	5,18	?	?	?	?	---	---	---	---	---	n/a	---	---	---
K2500 HEAVY DUTY	4x4	1995	All	No	All	All	All	All	8600	67865	5,18	?	?	?	?	---	---	---	---	---	n/a	---	---	---
K2500 HEAVY DUTY	4x4	1996	All	No	All	All	All	All	8600	67865	5,18	?	?	?	?	---	---	---	---	---	n/a	---	---	---

- Notes:**
- Ballast amounts are based on a "Representative Vehicle," defined in the vehicle selection guide instructions, and must be modified for all other configurations for axle and GVWR compliance.
  - Classic Style Only (2nd # in model # is 0 not 5) example: K10903. Refer to label in glove box for model number.
  - Recommended F60 suspension or snowplow prep package.

# 1996 & Prior Chevy/GMC

## Section 2 PRO-PLOW®, PRO PLUS® & Heavy Weight Blades

PRO-PLOW®					PRO PLUS®			
7'-6" STEEL	7'-6" POLY	8'-0" STEEL	8'-0" POLY	8'-6" STEEL	7'-6" STEEL	8'-0" STEEL	8'-6" STEEL	9'-0" STEEL
IUTP75	IUTPY75	IUTP80	IUTPY80	IUTP85	IUTPP75	IUTPP80	IUTPP85	IUTPP90
60381	62400	60390	62450	60308	64750	66980	66974	66901
67950					66490			
64588					64999			
28800					56369			
56369					56462			

Plow  
Blade Assembly  
AQ&L Assembly Box 1  
AQ&L Assembly Box 2  
Hydraulic Kit  
Light Kit  
Choose a Joystick Control  
or Hand-Held Control

Heavy Weight	
9'-0" STEEL	10'-0" STEEL
IUHW90	IUHW10
62301	62302
62298-1	
62299-1	
64400	
28800	
56369	
56462	

Model	Year	Body Style	DRW	Box Option	Engine Type	Min F G A W R	Min R G A W R	Min G V W R	Harness Kit	UltraMount® system		Ballast Guidelines, lbs (1)								UniMount® system		Ballast Guidelines, lbs (1)		
										Mount Kit	Notes	Mount Kit	Notes	Mount Kit	Notes	Mount Kit	Notes							
K30,K35	4x4	1973	All	No	All	All	All	All		63900	18	?	?	?	?	?	?	?	?	?	n/a	---	---	---
K30,K35	4x4	1974	All	No	All	All	All	All		63900	18	?	?	?	?	?	?	?	?	?	n/a	---	---	---
K30,K35	4x4	1975	All	No	All	All	All	All		63900	18	?	?	?	?	?	?	?	?	?	n/a	---	---	---
K30,K35	4x4	1976	All	No	All	All	All	All		63900	18	?	?	?	?	?	?	?	?	?	n/a	---	---	---
K30,K35	4x4	1977	All	No	All	All	All	All		63900	18	?	?	?	?	?	?	?	?	?	n/a	---	---	---
K30,K35	4x4	1978	All	No	All	All	All	All		63900	18	?	?	?	?	?	?	?	?	?	n/a	---	---	---
K30,K35	4x4	1979	All	No	All	All	All	All		63900	18	?	?	?	?	?	?	?	?	?	n/a	---	---	---
K30,K35	4x4	1980	All	No	All	All	All	All		63900	18	?	?	?	?	?	?	?	?	?	n/a	---	---	---
K30,K35	4x4	1981	All	No	All	All	All	All		63900	18	?	?	?	?	?	?	?	?	?	n/a	---	---	---
K30,K35	4x4	1982	All	No	All	All	All	All		63900	18	?	?	?	?	?	?	?	?	?	n/a	---	---	---
K30,K35	4x4	1983	All	No	All	All	All	All		63900	18	?	?	?	?	?	?	?	?	?	n/a	---	---	---
K30,K35	4x4	1984	All	No	All	All	All	All		63900	18	?	?	?	?	?	?	?	?	?	n/a	---	---	---
K30,K35	4x4	1985	All	No	All	All	All	All		63900	18	?	?	?	?	?	?	?	?	?	n/a	---	---	---
K30,K35	4x4	1986	All	No	All	All	All	All		63900	18	?	?	?	?	?	?	?	?	?	n/a	---	---	---
K30,K35	4x4	1987	All	No	All	All	All	All		63900	18	?	?	?	?	?	?	?	?	?	n/a	---	---	---
V30, V35 W/LEAF SPRINGS	4x4	1988	All	No	All	All	All	All	2B use 8439 or 1A/2A use 8436 & 26641	63900	18	?	?	?	?	?	?	?	?	?	n/a	---	---	---
V30, V35 W/LEAF SPRINGS	4x4	1989	All	No	All	All	All	All	2B use 8439 or 1A/2A use 8436 & 26641	63900	18	?	?	?	?	?	?	?	?	?	n/a	---	---	---
K3500	4x4	1988	All	No	All	All	All	All		67865	5,18	?	?	?	?	?	?	?	?	?	n/a	---	---	---
K3500	4x4	1989	All	No	All	All	All	All		67865	5,18	?	?	?	?	?	?	?	?	?	n/a	---	---	---
K3500	4x4	1990	All	No	All	All	All	All		67865	5,18	?	?	?	?	?	?	?	?	?	n/a	---	---	---
K3500	4x4	1991	All	No	All	All	All	All		67865	5,18	?	?	?	?	?	?	?	?	?	n/a	---	---	---
K3500	4x4	1992	All	No	All	All	All	All	2B use 8439 or HB3/HB4 use 8438 or LF/UF n/a	67865	5,18	?	?	?	?	?	?	?	?	?	n/a	---	---	---
K3500	4x4	1993	All	No	All	All	All	All		67865	5,18	?	?	?	?	?	?	?	?	?	n/a	---	---	---
K3500	4x4	1994	All	No	All	All	All	All		67865	5,18	?	?	?	?	?	?	?	?	?	n/a	---	---	---
K3500	4x4	1995	All	No	All	All	All	All		67865	5,18	?	?	?	?	?	?	?	?	?	n/a	---	---	---

- Notes:**
- Ballast amounts are based on a "Representative Vehicle," defined in the vehicle selection guide instructions, and must be modified for all other configurations for axle and GVWR compliance.
  - Classic Style Only (2nd # in model # is 0 not 5) example: K10903. Refer to label in glove box for model number.
  - Recommended F60 suspension or snowplow prep package.

# 1996 & Prior Chevy/GMC

## Section 2

### PRO-PLOW®, PRO PLUS® & Heavy Weight Blades

Model	Year	Body Style	DRW	Box Option	Engine Type	Min F G A W R	Min R G A W R	Min G V W R	Harness Kit	UltraMount® system		Ballast Guidelines, lbs (1)								UniMount® system		Ballast Guidelines, lbs (1)	
										Mount Kit	Notes	Mount Kit	Notes	Mount Kit	Notes	Mount Kit	Notes						
K3500	4x4	1996	All	No	All	All	All	All	2B use 8439 or HB3/HB4 use 8438	67865	5,18	?	?	?	?	?	?	?	?	n/a	---	---	---
KODIAK, TOPKICK	4x2	1990	All	Yes	Chassis	All	All	All	10001	n/a	---	---	---	---	---	---	---	---	---	62275	---	?	?
KODIAK, TOPKICK	4x2	1991	All	Yes	Chassis	All	All	All	10001	n/a	---	---	---	---	---	---	---	---	---	62275	---	?	?
KODIAK, TOPKICK	4x2	1992	All	Yes	Chassis	All	All	All	10001	n/a	---	---	---	---	---	---	---	---	---	62275	---	?	?
KODIAK, TOPKICK	4x2	1993	All	Yes	Chassis	All	All	All	10001	n/a	---	---	---	---	---	---	---	---	---	62275	---	?	?
KODIAK, TOPKICK	4x2	1994	All	Yes	Chassis	All	All	All	10001	n/a	---	---	---	---	---	---	---	---	---	62275	---	?	?
KODIAK, TOPKICK	4x2	1995	All	Yes	Chassis	All	All	All	10001	n/a	---	---	---	---	---	---	---	---	---	62275	---	?	?
KODIAK, TOPKICK	4x2	1996	All	Yes	Chassis	All	All	All	10001	n/a	---	---	---	---	---	---	---	---	---	62275	---	?	?

- Notes:**
- Ballast amounts are based on a "Representative Vehicle," defined in the vehicle selection guide instructions, and must be modified for all other configurations for axle and GVWR compliance.
  - Classic Style Only (2nd # in model # is 0 not 5) example: K10903. Refer to label in glove box for model number.
  - Recommended F60 suspension or snowplow prep package.

# 1996 & Prior Chevy/GMC

## Section 3

### MVP® & MVP PLUS™ Blades

<b>MVP®</b>		<b>MVP PLUS™</b>				
8'-6" STEEL	7'-6" STEEL	7'-6" POLY	8'-6" STEEL	8'-6" POLY	9'-6" STEEL	9'-6" POLY
<b>IUMVP85</b>	<b>IUTHVPP75</b>	<b>IUTHVPPY75</b>	<b>IUTHVPP85</b>	<b>IUTHVPPY85</b>	<b>IUTHVPP95</b>	<b>IUTHVPPY95</b>
Blade Assembly	63910	44475	44575	44485	44585	44495
AQ&L Assembly Box 1	63910					
AQ&L Assembly Box 2	67951-2					
Hydraulic Kit	64777			44225		
Light Kit	28800					
Choose a Joystick Control or Hand-Held Control	96369			96700		
	96462			96600		

Model	Year	Body Style	DRW	Box Option	Engine Type	Min F G A W R	Min R G A W R	Min G V W R	Harness Kit	UltraMount® system		Plow	Blade Assembly	AQ&L Assembly Box 1	AQ&L Assembly Box 2	Hydraulic Kit	Light Kit	Choose a Joystick Control or Hand-Held Control	
										Mount Kit	Notes								
K30,K35	4x4	1973	All	No	All	All	All	All	2B use 8439 or 1A/2A use 8436 & 26641	63900	18	---	?	?	?	?	?	?	
K30,K35	4x4	1974	All	No	All	All	All	All		63900	18	---	?	?	?	?	?	?	?
K30,K35	4x4	1975	All	No	All	All	All	All		63900	18	---	?	?	?	?	?	?	?
K30,K35	4x4	1976	All	No	All	All	All	All		63900	18	---	?	?	?	?	?	?	?
K30,K35	4x4	1977	All	No	All	All	All	All		63900	18	---	?	?	?	?	?	?	?
K30,K35	4x4	1978	All	No	All	All	All	All		63900	18	---	?	?	?	?	?	?	?
K30,K35	4x4	1979	All	No	All	All	All	All		63900	18	---	?	?	?	?	?	?	?
K30,K35	4x4	1980	All	No	All	All	All	All		63900	18	---	?	?	?	?	?	?	?
K30,K35	4x4	1981	All	No	All	All	All	All		63900	18	---	?	?	?	?	?	?	?
K30,K35	4x4	1982	All	No	All	All	All	All		63900	18	---	?	?	?	?	?	?	?
K30,K35	4x4	1983	All	No	All	All	All	All		63900	18	---	?	?	?	?	?	?	?
K30,K35	4x4	1984	All	No	All	All	All	All		63900	18	---	?	?	?	?	?	?	?
K30,K35	4x4	1985	All	No	All	All	All	All		63900	18	---	?	?	?	?	?	?	?
K30,K35	4x4	1986	All	No	All	All	All	All		63900	18	---	?	?	?	?	?	?	?
K30,K35	4x4	1987	All	No	All	All	All	All		63900	18	---	?	?	?	?	?	?	?
V30, V35 W/LEAF SPRINGS	4x4	1988	All	No	All	All	All	All	2B use 8439 or LF/UF n/a or 1A/2A use 8436 & 26641	63900	18	---	?	?	?	?	?	?	
V30, V35 W/LEAF SPRINGS	4x4	1989	All	No	All	All	All	All		63900	18	---	?	?	?	?	?	?	?
K3500	4x4	1988	All	No	All	All	All	All	2B use 8439 or HB3/HB4 use 8438 or LF/UF n/a	67865	5,18	---	?	?	?	?	?	?	
K3500	4x4	1989	All	No	All	All	All	All		67865	5,18	---	?	?	?	?	?	?	
K3500	4x4	1990	All	No	All	All	All	All		67865	5,18	---	?	?	?	?	?	?	
K3500	4x4	1991	All	No	All	All	All	All		67865	5,18	---	?	?	?	?	?	?	
K3500	4x4	1992	All	No	All	All	All	All		67865	5,18	---	?	?	?	?	?	?	
K3500	4x4	1993	All	No	All	All	All	All		67865	5,18	---	?	?	?	?	?	?	
K3500	4x4	1994	All	No	All	All	All	All		67865	5,18	---	?	?	?	?	?	?	
K3500	4x4	1995	All	No	All	All	All	All		67865	5,18	---	?	?	?	?	?	?	
K3500	4x4	1996	All	No	All	All	All	All	2B use 8439 or HB3/HB4 use 8438	67865	5,18	---	?	?	?	?	?	?	

- Notes:**
- Ballast amounts are based on a "Representative Vehicle," defined in the vehicle selection guide instructions, and must be modified for all other configurations for axle and GVWR compliance.
  - Classic Style Only (2nd # in model # is 0 not 5) example: K10903. Refer to label in glove box for model number.
  - Recommended F60 suspension or snowplow prep package.

# 1996 & Prior Dodge

## Section 1 Suburbanite™ & MIDWEIGHT™ Blades

 Suburbanite™	
6'-8" POLY	7'-4" POLY
<b>SUB68</b>	<b>SUB74</b>
Blade Assembly	27546 27548
AQ&L Assembly Box 1	27550
AQ&L Assembly Box 2	n/a
Hydraulic Kit	27516
Light Kit	64100
Choose a Joystick Control or Hand-Held Control	56369 56462

 UltraMount™	
MIDWEIGHT™	
7'-6" STEEL	7'-6" POLY
<b>IUTH75</b>	<b>IUTHY75</b>
64340	64330
64336	
67992	
64620	
28800	
56369	
56462	

Model	Year	Body Style	DRW	Box Option	Engine Type	Min F G A W R	Min R G A W R	Min G V W R	Harness Kit	Personal Plow system		Ballast Guidelines, lbs (1)		UltraMount® system		Ballast Guidelines, lbs (1)		
										Mount Kit	Notes			Mount Kit	Notes			
1500, 2500 LD	4x4	1994	All	No	All	All	All	All	7500	HB1 use 8436	n/a	---	---	---	67980	2,23	?	?
1500, 2500 LD	4x4	1995	All	No	All	All	All	All	7500		n/a	---	---	---	67980	2,23	?	?
1500, 2500 LD	4x4	1996	All	No	All	All	All	All	7500		n/a	---	---	---	67980	2,23	?	?
2500	4x4	1994	All	No	All	All	All	All	8800		n/a	---	---	---	67980	2,23	?	?
2500	4x4	1995	All	No	All	All	All	All	8800		n/a	---	---	---	67980	2,23	?	?
2500	4x4	1996	All	No	All	All	All	All	8800		n/a	---	---	---	67980	2,23	?	?
2500 W/EXT. CAB	4x4	1995	All	No	All	All	All	All	8800		n/a	---	---	---	67980	2,23	?	?
2500 W/EXT. CAB	4x4	1996	All	No	All	All	All	All	8800		n/a	---	---	---	67980	2,23	?	?

**Notes:**  
 1. Ballast amounts are based on a "Representative Vehicle," defined in the vehicle selection guide instructions, and must be modified for all other configurations for axle and GVWR compliance.  
 2. Recommended snowplow prep package whenever available.  
 23. Requires bumper notching on Sport and LE Sport option.

# 1996 & Prior Dodge

## Section 2

### PRO-PLOW®, PRO PLUS® & Heavy Weight Blades

UltraMount								
PRO-PLOW®					PRO PLUS®			
7'-6" STEEL	7'-6" POLY	8'-0" STEEL	8'-0" POLY	8'-6" STEEL	7'-6" STEEL	8'-0" STEEL	8'-6" STEEL	9'-0" STEEL
IUTP75	IUTPY75	IUTP80	IUTPY80	IUTP85	IUTPP75	IUTPP80	IUTPP85	IUTPP90
60381	62400	60390	62450	60308	64750	66980	66974	66901
67950					66490			
67951-2								
64588					64999			
Light Kit					28800			
Choose a Joystick Control					56369			
or Hand-Held Control					56462			

UniMount	
Heavy Weight	
9'-0" STEEL	10'-0" STEEL
IUHW90	IUHW10
62301	62302
62298-1	
62299-1	
64400	
28800	
56369	
56462	

Model	Year	Body Style	DRW	Box Option	Engine Type	Min F G A W R	Min R G A W R	Min S V W R	8800	Harness Kit	UltraMount® system		Ballast Guidelines, lbs (1)							UniMount® system		Ballast Guidelines, lbs (1)					
											Mount Kit	Notes	Mount Kit	Notes	Mount Kit	Notes	Mount Kit	Notes	Mount Kit	Notes							
2500	4x4	1994	All	No	All	All	All	All	8800	HB1 use 8436	67980	2,23	?	?	?	?	?	?	?	?	?	?	n/a	---	---	---	
2500	4x4	1995	All	No	All	All	All	All	8800		67980	2,23	?	?	?	?	?	?	?	?	?	?	?	n/a	---	---	---
2500	4x4	1996	All	No	All	All	All	All	8800		67980	2,23	?	?	?	?	?	?	?	?	?	?	?	n/a	---	---	---
2500 W/EXT. CAB	4x4	1995	All	No	All	All	All	All	8800		67980	2,23	?	?	?	?	?	?	?	?	?	?	?	n/a	---	---	---
2500 W/EXT. CAB	4x4	1996	All	No	All	All	All	All	8800		67980	2,23	?	?	?	?	?	?	?	?	?	?	?	n/a	---	---	---
3500	4x4	1994	All	Yes	All	All	All	All	All		67980	2,23	---	---	---	---	?	---	---	?	?	?	?	n/a	---	---	---
3500	4x4	1995	All	Yes	All	All	All	All	All		67980	2,23	---	---	---	---	?	---	---	?	?	?	?	n/a	---	---	---
3500	4x4	1996	All	Yes	All	All	All	All	All		67980	2,23	---	---	---	---	?	---	---	?	?	?	?	n/a	---	---	---
3500 W/ EXTENDED CAB	4x4	1995	All	Yes	All	All	All	All	All		67980	2,23	---	---	---	---	?	---	---	?	?	?	?	n/a	---	---	---
3500 W/ EXTENDED CAB	4x4	1996	All	Yes	All	All	All	All	All		67980	2,23	---	---	---	---	?	---	---	?	?	?	?	n/a	---	---	---

- Notes:**
1. Ballast amounts are based on a "Representative Vehicle," defined in the vehicle selection guide instructions, and must be modified for all other configurations for axle and GVWR compliance.
  2. Recommended snowplow prep package whenever available.
  23. Requires bumper notching on Sport and LE Sport option.



# 1996 & Prior Dodge

## Section 3 MVP® & MVP PLUS™ Blades

<b>MVP®</b>	<b>MVP PLUS™</b>					
8'-6" STEEL	7'-6" STEEL	7'-6" POLY	8'-6" STEEL	8'-6" POLY	9'-6" STEEL	9'-6" POLY
<b>IUMVP85</b>	<b>IUTHVPP75</b>	<b>IUTHVPPY75</b>	<b>IUTHVPP85</b>	<b>IUTHVPPY85</b>	<b>IUTHVPP95</b>	<b>IUTHVPPY95</b>
Blade Assembly 63819	44475	44575	44485	44585	44495	44595
AQ&L Assembly Box 1 63910	44225					
AQ&L Assembly Box 2 67951-2						
Hydraulic Kit 64777						
Light Kit 28800						
Choose a Joystick Control 96369	96700					
or Hand-Held Control 96462	96600					

Plow  
Blade Assembly  
AQ&L Assembly Box 1  
AQ&L Assembly Box 2  
Hydraulic Kit  
Light Kit  
Choose a Joystick Control  
or Hand-Held Control

Model	Year	Body Style	DRW	Box Option	Engine Type	Min F G A W R	Min R G A W R	Min S V W R	Harness Kit	UltraMount® system		Plow							
										Mount Kit	Notes	8'-6" STEEL	7'-6" STEEL	7'-6" POLY	8'-6" STEEL	8'-6" POLY	9'-6" STEEL	9'-6" POLY	
2500	4x4	1994	All	No	All	All	All	8800	HB1 use 8436	67980	2,23	?	?	?	?	?	?	?	
2500	4x4	1995	All	No	All	All	All	8800		67980	2,23	?	?	?	?	?	?	?	?
2500	4x4	1996	All	No	All	All	All	8800		67980	2,23	?	?	?	?	?	?	?	?
2500 W/EXT. CAB	4x4	1995	All	No	All	All	All	8800		67980	2,23	?	?	?	?	?	?	?	?
2500 W/EXT. CAB	4x4	1996	All	No	All	All	All	8800		67980	2,23	?	?	?	?	?	?	?	?
3500	4x4	1994	All	Yes	All	All	All	All		67980	2,23	?	---	---	?	?	?	?	?
3500	4x4	1995	All	Yes	All	All	All	All		67980	2,23	?	---	---	?	?	?	?	?
3500	4x4	1996	All	Yes	All	All	All	All		67980	2,23	?	---	---	?	?	?	?	?
3500 W/ EXTENDED CAB	4x4	1995	All	Yes	All	All	All	All		67980	2,23	?	---	---	?	?	?	?	?
3500 W/ EXTENDED CAB	4x4	1996	All	Yes	All	All	All	All		67980	2,23	?	---	---	?	?	?	?	?

- Notes:**
- Ballast amounts are based on a "Representative Vehicle," defined in the vehicle selection guide instructions, and must be modified for all other configurations for axle and GVWR compliance.
  - Recommended snowplow prep package whenever available.
  - Requires bumper notching on Sport and LE Sport option.

# 1996 & Prior Ford

## Section 1 Suburbanite™ & MIDWEIGHT™ Blades

	
<b>Suburbanite™</b>	
6'-8" POLY	7'-4" POLY
<b>SUB68</b>	<b>SUB74</b>
27546	27548
27550	
n/a	
27516	
64100	
56369	
56462	

	
<b>MIDWEIGHT™</b>	
7'-6" STEEL	7'-6" POLY
<b>IUTH75</b>	<b>IUTW75</b>
64340	64330
64336	
67992	
64620	
28800	
56369	
56462	

Plow  
Blade Assembly  
AQ&L Assembly Box 1  
AQ&L Assembly Box 2  
Hydraulic Kit  
Light Kit  
Choose a Joystick Control  
or Hand-Held Control

Model	Year	Body Style	DRW	Box Option	Engine Type	Min F G A W R	Min R G A W R	Min G V W R	Harness Kit	Personal Plow system		Ballast Guidelines, lbs (1)		UltraMount® system		Ballast Guidelines, lbs (1)		
										Mount Kit	Notes			Mount Kit	Notes			
EXPLORER	4x4	1995	All	No	All	All	All	All	HB5 use 8436	1203	3,8	?	?	n/a	---	---	---	
EXPLORER	4x4	1996	All	No	All	All	All	All		1203	3,8	?	?	n/a	---	---	---	
BRONCO	4x4	1980	All	No	All	All	All	All	2B use 8439 or HB1 use 8436	n/a	---	---	---	63710-1	24	?	?	
BRONCO	4x4	1981	All	No	All	All	All	All		n/a	---	---	---	63710-1	24	?	?	
BRONCO	4x4	1982	All	No	All	All	All	All		n/a	---	---	---	63710-1	24	?	?	
BRONCO	4x4	1983	All	No	All	All	All	All		n/a	---	---	---	63710-1	24	?	?	
BRONCO	4x4	1984	All	No	All	All	All	All		n/a	---	---	---	63710-1	24	?	?	
BRONCO	4x4	1985	All	No	All	All	All	All		n/a	---	---	---	63710-1	24	?	?	
BRONCO	4x4	1986	All	No	All	All	All	All		n/a	---	---	---	63710-1	24	?	?	
BRONCO	4x4	1987	All	No	All	All	All	All		n/a	---	---	---	63710-1	24	?	?	
BRONCO	4x4	1988	All	No	All	All	All	All		n/a	---	---	---	63710-1	24	?	?	
BRONCO	4x4	1989	All	No	All	All	All	All		n/a	---	---	---	63710-1	24	?	?	
BRONCO	4x4	1990	All	No	All	All	All	All		n/a	---	---	---	63710-1	24	?	?	
BRONCO	4x4	1991	All	No	All	All	All	All		n/a	---	---	---	63710-1	24	?	?	
BRONCO	4x4	1992	All	No	All	All	All	All		HB5 use 8436	n/a	---	---	---	1369	2,10	?	?
BRONCO	4x4	1993	All	No	All	All	All	All		n/a	---	---	---	1369	2,10	?	?	
F150	4x4	1980	All	No	All	All	All	All	2B use 8439 or HB1 use 8436	n/a	---	---	---	63710-1	24	?	?	
F150	4x4	1981	All	No	All	All	All	All		n/a	---	---	---	63710-1	24	?	?	
F150	4x4	1982	All	No	All	All	All	All		n/a	---	---	---	63710-1	24	?	?	
F150	4x4	1983	All	No	All	All	All	All		n/a	---	---	---	63710-1	24	?	?	
F150	4x4	1984	All	No	All	All	All	All		n/a	---	---	---	63710-1	24	?	?	
F150	4x4	1985	All	No	All	All	All	All		n/a	---	---	---	63710-1	24	?	?	
F150	4x4	1986	All	No	All	All	All	All		n/a	---	---	---	63710-1	24	?	?	
F150	4x4	1987	All	No	All	All	All	All		n/a	---	---	---	63710-1	24	?	?	
F150	4x4	1988	All	No	All	All	All	All		n/a	---	---	---	63710-1	24	?	?	
F150	4x4	1989	All	No	All	All	All	All		n/a	---	---	---	63710-1	24	?	?	
F150	4x4	1990	All	No	All	All	All	All		n/a	---	---	---	63710-1	24	?	?	
F150	4x4	1991	All	No	All	All	All	All		n/a	---	---	---	63710-1	24	?	?	
F150	4x4	1992	All	No	All	All	All	All		n/a	---	---	---	1369	2,10	?	?	
F150	4x4	1993	All	No	All	All	All	All		HB5 use 8436	n/a	---	---	---	1369	2,10	?	?
F150	4x4	1994	All	No	All	All	All	All	n/a	---	---	---	1369	2,10	?	?		
F150	4x4	1995	All	No	All	All	All	All	n/a	---	---	---	1369	2,10	?	?		
F150	4x4	1996	All	No	All	All	All	All	n/a	---	---	---	1369	2,10	?	?		

- Notes:**
- Ballast amounts are based on a "Representative Vehicle," defined in the vehicle selection guide instructions, and must be modified for all other configurations for axle and GVWR compliance.
  - Recommended snowplow prep package whenever available.
  - Requires bumper notching.
  - These Snowplows Are For Personal/Homeowner Use Only.
  - May require bumper or air dam notching.
  - Requires front air bags.

# 1996 & Prior Ford

## Section 1 Suburbanite™ & MIDWEIGHT™ Blades

	
<b>Suburbanite™</b>	
6'-8" POLY	7'-4" POLY
<b>SUB68</b>	<b>SUB74</b>
27546	27548
27550	
n/a	
27516	
64100	
56369	
56462	

	
<b>MIDWEIGHT™</b>	
7'-6" STEEL	7'-6" POLY
<b>IUTM75</b>	<b>IUTW75</b>
64340	64330
64336	
67992	
64620	
28800	
56369	
56462	

Plow  
Blade Assembly  
AQ&L Assembly Box 1  
AQ&L Assembly Box 2  
Hydraulic Kit  
Light Kit  
Choose a Joystick Control  
or Hand-Held Control

Model	Year	Body Style	DRW	Box Option	Engine Type	Min F G A W R	Min R G A W R	Min G V W R	Harness Kit	Personal Plow system		Ballast Guidelines, lbs (1)		UltraMount® system		Ballast Guidelines, lbs (1)	
										Mount Kit	Notes			Mount Kit	Notes		
F250	4x4	1980	All	No	All	All	All	All		n/a	---	---	---	63710-1	24	?	?
F250	4x4	1981	All	No	All	All	All	All		n/a	---	---	---	63710-1	24	?	?
F250	4x4	1982	All	No	All	All	All	All		n/a	---	---	---	63710-1	24	?	?
F250	4x4	1983	All	No	All	All	All	All		n/a	---	---	---	63710-1	24	?	?
F250	4x4	1984	All	No	All	All	All	All		n/a	---	---	---	63710-1	24	?	?
F250	4x4	1985	All	No	All	All	All	All		n/a	---	---	---	63710-1	24	?	?
F250	4x4	1986	All	No	All	All	All	All		n/a	---	---	---	63710-1	24	?	?
F250	4x4	1987	All	No	All	All	All	All		n/a	---	---	---	63710-1	24	?	?
F250	4x4	1988	All	No	All	All	All	All		n/a	---	---	---	63710-1	24	?	?
F250	4x4	1989	All	No	All	All	All	All		n/a	---	---	---	63710-1	24	?	?
F250	4x4	1990	All	No	All	All	All	All		n/a	---	---	---	63710-1	24	?	?
F250	4x4	1991	All	No	All	All	All	All		n/a	---	---	---	63710-1	24	?	?
F250HD	4x4	1992	All	No	All	All	All	All		n/a	---	---	---	1379	2,10	?	?
F250HD	4x4	1993	All	No	All	All	All	All		n/a	---	---	---	1379	2,10	?	?
F250HD	4x4	1994	All	No	All	All	All	All		n/a	---	---	---	1379	2,10	?	?
F250HD	4x4	1995	All	No	All	All	All	All		n/a	---	---	---	1379	2,10	?	?
F250HD	4x4	1996	All	No	All	All	All	All		n/a	---	---	---	1379	2,10	?	?
F250HD W/ SUPERCAB	4x4	1995	All	No	All	All	All	All		n/a	---	---	---	1379	2,10	?	?
F250HD W/ SUPERCAB	4x4	1996	All	No	All	All	All	All		n/a	---	---	---	1379	2,10	?	?

**Notes:**  
 1. Ballast amounts are based on a "Representative Vehicle," defined in the vehicle selection guide instructions, and must be modified for all other configurations for axle and GVWR compliance.  
 2. Recommended snowplow prep package whenever available.

10. May require bumper or air dam notching.  
 24. Requires front air bags.

# 1996 & Prior Ford

## Section 2

### PRO-PLOW®, PRO PLUS® & Heavy Weight Blades

UltraMount								
PRO-PLOW®					PRO PLUS®			
7'-6" STEEL	7'-6" POLY	8'-0" STEEL	8'-0" POLY	8'-6" STEEL	7'-6" STEEL	8'-0" STEEL	8'-6" STEEL	9'-0" STEEL
IUTP75	IUTPY75	IUTP80	IUTPY80	IUTP85	IUTPP75	IUTPP80	IUTPP85	IUTPP90
60381	62400	60390	62450	60308	64750	66980	66974	66901
67950					66490			
64588					64999			
28800					56369			
56369					56462			

UniMount	
Heavy Weight	
9'-0" STEEL	10'-0" STEEL
IUHW90	IUHW10
62301	62302
62298-1	
62299-1	
64400	
28800	
56369	
56462	

Plow  
Blade Assembly  
AQ&L Assembly Box 1  
AQ&L Assembly Box 2  
Hydraulic Kit  
Light Kit  
Choose a Joystick Control  
or Hand-Held Control

Model	Year	Body Style	DRW	Box Option	Engine Type	Min F G A W R	Min R G A W R	Min S V W R	Harness Kit	UltraMount® system		Ballast Guidelines, lbs (1)								UniMount® system		Ballast Guidelines, lbs (1)			
										Mount Kit	Notes	Mount Kit	Notes	Mount Kit	Notes	Mount Kit	Notes	Mount Kit	Notes						
BRONCO	4x4	1980	All	No	All	All	All	All	2B use 8439 or HB1 use 8436	63710-1	24	?	?	?	?	---	---	---	---	---	n/a	---	---	---	
BRONCO	4x4	1981	All	No	All	All	All	All		63710-1	24	?	?	?	?	---	---	---	---	---	---	n/a	---	---	---
BRONCO	4x4	1982	All	No	All	All	All	All		63710-1	24	?	?	?	?	---	---	---	---	---	---	n/a	---	---	---
BRONCO	4x4	1983	All	No	All	All	All	All		63710-1	24	?	?	?	?	---	---	---	---	---	---	n/a	---	---	---
BRONCO	4x4	1984	All	No	All	All	All	All		63710-1	24	?	?	?	?	---	---	---	---	---	---	n/a	---	---	---
BRONCO	4x4	1985	All	No	All	All	All	All		63710-1	24	?	?	?	?	---	---	---	---	---	---	n/a	---	---	---
BRONCO	4x4	1986	All	No	All	All	All	All		63710-1	24	?	?	?	?	---	---	---	---	---	---	n/a	---	---	---
BRONCO	4x4	1987	All	No	All	All	All	All		63710-1	24	?	?	?	?	---	---	---	---	---	---	n/a	---	---	---
BRONCO	4x4	1988	All	No	All	All	All	All		63710-1	24	?	?	?	?	---	---	---	---	---	---	n/a	---	---	---
BRONCO	4x4	1989	All	No	All	All	All	All		63710-1	24	?	?	?	?	---	---	---	---	---	---	n/a	---	---	---
BRONCO	4x4	1990	All	No	All	All	All	All	63710-1	24	?	?	?	?	---	---	---	---	---	---	n/a	---	---	---	
BRONCO	4x4	1991	All	No	All	All	All	All	63710-1	24	?	?	?	?	---	---	---	---	---	---	n/a	---	---	---	
BRONCO	4x4	1992	All	No	All	All	All	All	HB5 use 8436	1369	2,10	?	?	?	?	---	---	---	---	---	n/a	---	---	---	
BRONCO	4x4	1993	All	No	All	All	All	All		1369	2,10	?	?	?	?	---	---	---	---	---	---	n/a	---	---	---
F150	4x4	1980	All	No	All	All	All	All	2B use 8439 or HB1 use 8436	63710-1	24	?	?	?	?	---	---	---	---	---	---	n/a	---	---	---
F150	4x4	1981	All	No	All	All	All	All		63710-1	24	?	?	?	?	---	---	---	---	---	---	n/a	---	---	---
F150	4x4	1982	All	No	All	All	All	All		63710-1	24	?	?	?	?	---	---	---	---	---	---	n/a	---	---	---
F150	4x4	1983	All	No	All	All	All	All		63710-1	24	?	?	?	?	---	---	---	---	---	---	n/a	---	---	---
F150	4x4	1984	All	No	All	All	All	All		63710-1	24	?	?	?	?	---	---	---	---	---	---	n/a	---	---	---
F150	4x4	1985	All	No	All	All	All	All		63710-1	24	?	?	?	?	---	---	---	---	---	---	n/a	---	---	---
F150	4x4	1986	All	No	All	All	All	All		63710-1	24	?	?	?	?	---	---	---	---	---	---	n/a	---	---	---
F150	4x4	1987	All	No	All	All	All	All		63710-1	24	?	?	?	?	---	---	---	---	---	---	n/a	---	---	---
F150	4x4	1988	All	No	All	All	All	All		63710-1	24	?	?	?	?	---	---	---	---	---	---	n/a	---	---	---
F150	4x4	1989	All	No	All	All	All	All		63710-1	24	?	?	?	?	---	---	---	---	---	---	n/a	---	---	---
F150	4x4	1990	All	No	All	All	All	All	63710-1	24	?	?	?	?	---	---	---	---	---	---	n/a	---	---	---	
F150	4x4	1991	All	No	All	All	All	All	63710-1	24	?	?	?	?	---	---	---	---	---	---	n/a	---	---	---	
F150	4x4	1992	All	No	All	All	All	All	HB5 use 8436	1369	2,10	?	?	?	?	---	---	---	---	---	n/a	---	---	---	
F150	4x4	1993	All	No	All	All	All	All		1369	2,10	?	?	?	?	---	---	---	---	---	---	n/a	---	---	---
F150	4x4	1994	All	No	All	All	All	All		1369	2,10	?	?	?	?	---	---	---	---	---	---	n/a	---	---	---
F150	4x4	1995	All	No	All	All	All	All		1369	2,10	?	?	?	?	---	---	---	---	---	---	n/a	---	---	---
F150	4x4	1996	All	No	All	All	All	All		1369	2,10	?	?	?	?	---	---	---	---	---	---	n/a	---	---	---

Notes:  
1. Ballast amounts are based on a "Representative Vehicle," defined in the vehicle selection guide instructions, and must be modified for all other configurations for axle and GVWR compliance.  
2. Recommended snowplow prep package whenever available.

10. May require bumper or air dam notching.  
24. Requires front air bags.

# 1996 & Prior Ford

## Section 2 PRO-PLOW®, PRO PLUS® & Heavy Weight Blades

UltraMount								
PRO-PLOW®					PRO PLUS®			
7'-6" STEEL	7'-6" POLY	8'-0" STEEL	8'-0" POLY	8'-6" STEEL	7'-6" STEEL	8'-0" STEEL	8'-6" STEEL	9'-0" STEEL
IUTP75	IUTPY75	IUTP80	IUTPY80	IUTP85	IUTPP75	IUTPP80	IUTPP85	IUTPP90
60381	62400	60390	62450	60308	64750	66980	66974	66901
67950					66490			
64588					64999			
28800					56369			
56369					56462			

UniMount	
Heavy Weight	
9'-0" STEEL	10'-0" STEEL
IUHW90	IUHW10
62301	62302
62298-1	
62299-1	
64400	
28800	
56369	
56462	

Plow  
Blade Assembly  
AQ&L Assembly Box 1  
AQ&L Assembly Box 2  
Hydraulic Kit  
Light Kit  
Choose a Joystick Control  
or Hand-Held Control

Model	Year	Body Style	DRW	Box Option	Engine Type	Min F G A W R	Min R G A W R	Min G V W R	Harness Kit	UltraMount® system		Ballast Guidelines, lbs (1)								UniMount® system		Ballast Guidelines, lbs (1)	
										Mount Kit	Notes	Mount Kit	Notes	Mount Kit	Notes	Mount Kit	Notes						
F250	4x4	1980	All	No	All	All	All	All		63710-1	24	?	?	?	?	?	?	?	?	n/a	---	---	---
F250	4x4	1981	All	No	All	All	All	All		63710-1	24	?	?	?	?	?	?	?	?	n/a	---	---	---
F250	4x4	1982	All	No	All	All	All	All		63710-1	24	?	?	?	?	?	?	?	?	n/a	---	---	---
F250	4x4	1983	All	No	All	All	All	All		63710-1	24	?	?	?	?	?	?	?	?	n/a	---	---	---
F250	4x4	1984	All	No	All	All	All	All		63710-1	24	?	?	?	?	?	?	?	?	n/a	---	---	---
F250	4x4	1985	All	No	All	All	All	All		63710-1	24	?	?	?	?	?	?	?	?	n/a	---	---	---
F250	4x4	1986	All	No	All	All	All	All		63710-1	24	?	?	?	?	?	?	?	?	n/a	---	---	---
F250	4x4	1987	All	No	All	All	All	All		63710-1	24	?	?	?	?	?	?	?	?	n/a	---	---	---
F250	4x4	1988	All	No	All	All	All	All		63710-1	24	?	?	?	?	?	?	?	?	n/a	---	---	---
F250	4x4	1989	All	No	All	All	All	All		63710-1	24	?	?	?	?	?	?	?	?	n/a	---	---	---
F250	4x4	1990	All	No	All	All	All	All		63710-1	24	?	?	?	?	?	?	?	?	n/a	---	---	---
F250	4x4	1991	All	No	All	All	All	All		63710-1	24	?	?	?	?	?	?	?	?	n/a	---	---	---
F250HD	4x4	1992	All	No	All	All	All	All		1379	2,10	?	?	?	?	?	?	?	?	n/a	---	---	---
F250HD	4x4	1993	All	No	All	All	All	All		1379	2,10	?	?	?	?	?	?	?	?	n/a	---	---	---
F250HD	4x4	1994	All	No	All	All	All	All		1379	2,10	?	?	?	?	?	?	?	?	n/a	---	---	---
F250HD	4x4	1995	All	No	All	All	All	All		1379	2,10	?	?	?	?	?	?	?	?	n/a	---	---	---
F250HD	4x4	1996	All	No	All	All	All	All		1379	2,10	?	?	?	?	?	?	?	?	n/a	---	---	---
F250HD W/ SUPERCAB	4x4	1995	All	No	All	All	All	All		1379	2,10	?	?	?	?	?	?	?	?	n/a	---	---	---
F250HD W/ SUPERCAB	4x4	1996	All	No	All	All	All	All		1379	2,10	?	?	?	?	?	?	?	?	n/a	---	---	---
F350	4x4	1980	All	No	All	All	All	All		63710-1	24	?	?	?	?	?	?	?	?	n/a	---	---	---
F350	4x4	1981	All	No	All	All	All	All		63710-1	24	?	?	?	?	?	?	?	?	n/a	---	---	---
F350	4x4	1982	All	No	All	All	All	All		63710-1	24	?	?	?	?	?	?	?	?	n/a	---	---	---
F350	4x4	1983	All	No	All	All	All	All		63710-1	24	?	?	?	?	?	?	?	?	n/a	---	---	---
F350	4x4	1984	All	No	All	All	All	All		63710-1	24	?	?	?	?	?	?	?	?	n/a	---	---	---
F350	4x4	1985	All	No	All	All	All	All		63710-1	24	?	?	?	?	?	?	?	?	n/a	---	---	---
F350	4x4	1986	All	No	All	All	All	All		63710-1	24	?	?	?	?	?	?	?	?	n/a	---	---	---
F350	4x4	1987	All	No	All	All	All	All		63710-1	24	?	?	?	?	?	?	?	?	n/a	---	---	---
F350	4x4	1988	All	No	All	All	All	All		63710-1	24	?	?	?	?	?	?	?	?	n/a	---	---	---
F350	4x4	1989	All	No	All	All	All	All		63710-1	24	?	?	?	?	?	?	?	?	n/a	---	---	---
F350	4x4	1990	All	No	All	All	All	All		63710-1	24	?	?	?	?	?	?	?	?	n/a	---	---	---
F350	4x4	1991	All	No	All	All	All	All		63710-1	24	?	?	?	?	?	?	?	?	n/a	---	---	---
F350	4x4	1992	All	No	All	All	All	All		1379	2,10	?	?	?	?	?	?	?	?	n/a	---	---	---
F350	4x4	1993	All	No	All	All	All	All		1379	2,10	?	?	?	?	?	?	?	?	n/a	---	---	---
F350	4x4	1994	All	No	All	All	All	All		1379	2,10	?	?	?	?	?	?	?	?	n/a	---	---	---
F350	4x4	1995	All	No	All	All	All	All		1379	2,10	?	?	?	?	?	?	?	?	n/a	---	---	---
F350	4x4	1996	All	No	All	All	All	All		1379	2,10	?	?	?	?	?	?	?	?	n/a	---	---	---

- Notes:
- Ballast amounts are based on a "Representative Vehicle," defined in the vehicle selection guide instructions, and must be modified for all other configurations for axle and GVWR compliance.
  - Recommended snowplow prep package whenever available.

- May require bumper or air dam notching.
- Requires front air bags.

# 1996 & Prior Ford

## Section 2

### PRO-PLOW®, PRO PLUS® & Heavy Weight Blades

UltraMount								
PRO-PLOW®					PRO PLUS®			
7'-6" STEEL	7'-6" POLY	8'-0" STEEL	8'-0" POLY	8'-6" STEEL	7'-6" STEEL	8'-0" STEEL	8'-6" STEEL	9'-0" STEEL
IUTP75	IUTPY75	IUTP80	IUTPY80	IUTP85	IUTPP75	IUTPP80	IUTPP85	IUTPP90
60381	62400	60390	62450	60308	64750	66980	66974	66901
67950					66490			
64588					64999			
28800					56369			
56369					56462			

UniMount	
Heavy Weight	
9'-0" STEEL	10'-0" STEEL
IUHW90	IUHW10
62301	62302
62298-1	
62299-1	
64400	
28800	
56369	
56462	

Plow  
Blade Assembly  
AQ&L Assembly Box 1  
AQ&L Assembly Box 2  
Hydraulic Kit  
Light Kit  
Choose a Joystick Control  
or Hand-Held Control

Model	Year	Body Style	DRW	Box Option	Engine Type	Min F G A W R	Min R G A W R	Min S V W R	Harness Kit	UltraMount® system		Ballast Guidelines, lbs (1)								UniMount® system		Ballast Guidelines, lbs (1)			
										Mount Kit	Notes	Mount Kit	Notes	Mount Kit	Notes	Mount Kit	Notes	Mount Kit	Notes						
F-SUPERDUTY	4x2	1980	All	No	All	All	All	10000	2B use 8439 or HB1 use 8436	63710-1	24	?	?	?	?	?	?	?	?	?	n/a	---	---	---	
F-SUPERDUTY	4x2	1981	All	No	All	All	All	10000		63710-1	24	?	?	?	?	?	?	?	?	?	?	n/a	---	---	---
F-SUPERDUTY	4x2	1982	All	No	All	All	All	10000		63710-1	24	?	?	?	?	?	?	?	?	?	?	n/a	---	---	---
F-SUPERDUTY	4x2	1983	All	No	All	All	All	10000		63710-1	24	?	?	?	?	?	?	?	?	?	?	n/a	---	---	---
F-SUPERDUTY	4x2	1984	All	No	All	All	All	10000		63710-1	24	?	?	?	?	?	?	?	?	?	?	n/a	---	---	---
F-SUPERDUTY	4x2	1985	All	No	All	All	All	10000		63710-1	24	?	?	?	?	?	?	?	?	?	?	n/a	---	---	---
F-SUPERDUTY	4x2	1986	All	No	All	All	All	10000		63710-1	24	?	?	?	?	?	?	?	?	?	?	n/a	---	---	---
F-SUPERDUTY	4x2	1987	All	No	All	All	All	10000		63710-1	24	?	?	?	?	?	?	?	?	?	?	n/a	---	---	---
F-SUPERDUTY	4x2	1988	All	No	All	All	All	10000		63710-1	24	?	?	?	?	?	?	?	?	?	?	n/a	---	---	---
F-SUPERDUTY	4x2	1989	All	No	All	All	All	10000		63710-1	24	?	?	?	?	?	?	?	?	?	?	n/a	---	---	---
F-SUPERDUTY	4x2	1990	All	No	All	All	All	10000	63710-1	24	?	?	?	?	?	?	?	?	?	?	n/a	---	---	---	
F-SUPERDUTY	4x2	1991	All	No	All	All	All	10000	63710-1	24	?	?	?	?	?	?	?	?	?	?	n/a	---	---	---	
F-SUPERDUTY	4x2	1992	All	No	All	All	All	10000	HB5 use 8436	1379	2,10	?	?	?	?	?	?	?	?	?	n/a	---	---	---	
F-SUPERDUTY	4x2	1993	All	No	All	All	All	10000		1379	2,10	?	?	?	?	?	?	?	?	?	?	n/a	---	---	---
F-SUPERDUTY	4x2	1994	All	No	All	All	All	10000		1379	2,10	?	?	?	?	?	?	?	?	?	?	n/a	---	---	---
F-SUPERDUTY	4x2	1995	All	No	All	All	All	10000		1379	2,10	?	?	?	?	?	?	?	?	?	?	n/a	---	---	---
F-SUPERDUTY	4x2	1996	All	No	All	All	All	10000		1379	2,10	?	?	?	?	?	?	?	?	?	?	n/a	---	---	---
F700, F800	4x2	1985	All	Yes	Chassis	All	All	10001	2B/2D use 8439 & 26640	n/a	---	---	---	---	---	---	---	---	---	---	62275	---	?	?	
F700, F800	4x2	1986	All	Yes	Chassis	All	All	10001		n/a	---	---	---	---	---	---	---	---	---	---	---	62275	---	?	?
F700, F800	4x2	1987	All	Yes	Chassis	All	All	10001		n/a	---	---	---	---	---	---	---	---	---	---	---	62275	---	?	?
F700, F800	4x2	1988	All	Yes	Chassis	All	All	10001		n/a	---	---	---	---	---	---	---	---	---	---	---	62275	---	?	?
F700, F800	4x2	1989	All	Yes	Chassis	All	All	10001		n/a	---	---	---	---	---	---	---	---	---	---	---	62275	---	?	?
F700, F800	4x2	1990	All	Yes	Chassis	All	All	10001		n/a	---	---	---	---	---	---	---	---	---	---	---	62275	---	?	?
F700, F800	4x2	1991	All	Yes	Chassis	All	All	10001		n/a	---	---	---	---	---	---	---	---	---	---	---	62275	---	?	?
F700, F800	4x2	1992	All	Yes	Chassis	All	All	10001		n/a	---	---	---	---	---	---	---	---	---	---	---	62275	---	?	?
F700, F800	4x2	1993	All	Yes	Chassis	All	All	10001		n/a	---	---	---	---	---	---	---	---	---	---	---	62275	---	?	?
F700, F800	4x2	1994	All	Yes	Chassis	All	All	10001		n/a	---	---	---	---	---	---	---	---	---	---	---	62275	---	?	?
F700, F800	4x2	1995	All	Yes	Chassis	All	All	10001		n/a	---	---	---	---	---	---	---	---	---	---	---	62275	---	?	?
F700, F800	4x2	1996	All	Yes	Chassis	All	All	10001		n/a	---	---	---	---	---	---	---	---	---	---	---	62275	---	?	?

Notes:  
1. Ballast amounts are based on a "Representative Vehicle," defined in the vehicle selection guide instructions, and must be modified for all other configurations for axle and GVWR compliance.  
2. Recommended snowplow prep package whenever available.

10. May require bumper or air dam notching.  
24. Requires front air bags.

# 1996 & Prior Ford

## Section 3 MVP® & MVP PLUS™ Blades

<b>MVP®</b>		<b>MVP PLUS™</b>				
8'-6" STEEL	7'-6" STEEL	7'-6" POLY	8'-6" STEEL	8'-6" POLY	9'-6" STEEL	9'-6" POLY
<b>IUMVP85</b>	<b>IUTHVPP75</b>	<b>IUTHVPPY75</b>	<b>IUTHVPP85</b>	<b>IUTHVPPY85</b>	<b>IUTHVPP95</b>	<b>IUTHVPPY95</b>
Blade Assembly	63910	44475	44575	44485	44585	44495
AQ&L Assembly Box 1	63910					
AQ&L Assembly Box 2	67951-2					
Hydraulic Kit	64777			44225		
Light Kit	28800					
Choose a Joystick Control or Hand-Held Control	96369			96700		
	96462			96600		

Model	Year	Body Style	DRW	Box Option	Engine Type	Min F G A W R	Min R G A W R	Min G V W R	Harness Kit	UltraMount® system		Plow						
										Mount Kit	Notes	Plow	Blade Assembly	AQ&L Assembly Box 1	AQ&L Assembly Box 2	Hydraulic Kit	Light Kit	Choose a Joystick Control or Hand-Held Control
F250	4x4	1980	All	No	All	All	All	All		63710-1	24	?	---	---	---	---	---	---
F250	4x4	1981	All	No	All	All	All	All		63710-1	24	?	---	---	---	---	---	---
F250	4x4	1982	All	No	All	All	All	All		63710-1	24	?	---	---	---	---	---	---
F250	4x4	1983	All	No	All	All	All	All		63710-1	24	?	---	---	---	---	---	---
F250	4x4	1984	All	No	All	All	All	All		63710-1	24	?	---	---	---	---	---	---
F250	4x4	1985	All	No	All	All	All	All		63710-1	24	?	---	---	---	---	---	---
F250	4x4	1986	All	No	All	All	All	All		63710-1	24	?	---	---	---	---	---	---
F250	4x4	1987	All	No	All	All	All	All		63710-1	24	?	?	?	?	?	?	?
F250	4x4	1988	All	No	All	All	All	All		63710-1	24	?	?	?	?	?	?	?
F250	4x4	1989	All	No	All	All	All	All		63710-1	24	?	?	?	?	?	?	?
F250	4x4	1990	All	No	All	All	All	All		63710-1	24	?	?	?	?	?	?	?
F250	4x4	1991	All	No	All	All	All	All		63710-1	24	?	?	?	?	?	?	?
F250HD	4x4	1992	All	No	All	All	All	All		1379	2,10	?	?	?	?	?	?	?
F250HD	4x4	1993	All	No	All	All	All	All		1379	2,10	?	?	?	?	?	?	?
F250HD	4x4	1994	All	No	All	All	All	All		1379	2,10	?	?	?	?	?	?	?
F250HD	4x4	1995	All	No	All	All	All	All		1379	2,10	?	?	?	?	?	?	?
F250HD	4x4	1996	All	No	All	All	All	All		1379	2,10	?	?	?	?	?	?	?
F250HD W/ SUPERCAB	4x4	1995	All	No	All	All	All	All		1379	2,10	---	?	?	?	?	?	?
F250HD W/ SUPERCAB	4x4	1996	All	No	All	All	All	All		1379	2,10	---	?	?	?	?	?	?
F350	4x4	1980	All	No	All	All	All	All		63710-1	24	?	---	---	---	---	---	---
F350	4x4	1981	All	No	All	All	All	All		63710-1	24	?	---	---	---	---	---	---
F350	4x4	1982	All	No	All	All	All	All		63710-1	24	?	---	---	---	---	---	---
F350	4x4	1983	All	No	All	All	All	All		63710-1	24	?	---	---	---	---	---	---
F350	4x4	1984	All	No	All	All	All	All		63710-1	24	?	---	---	---	---	---	---
F350	4x4	1985	All	No	All	All	All	All		63710-1	24	?	---	---	---	---	---	---
F350	4x4	1986	All	No	All	All	All	All		63710-1	24	?	---	---	---	---	---	---
F350	4x4	1987	All	No	All	All	All	All		63710-1	24	?	?	?	?	?	?	?
F350	4x4	1988	All	No	All	All	All	All		63710-1	24	?	?	?	?	?	?	?
F350	4x4	1989	All	No	All	All	All	All		63710-1	24	?	?	?	?	?	?	?
F350	4x4	1990	All	No	All	All	All	All		63710-1	24	?	?	?	?	?	?	?
F350	4x4	1991	All	No	All	All	All	All		63710-1	24	?	?	?	?	?	?	?
F350	4x4	1992	All	No	All	All	All	All		1379	2,10	?	?	?	?	?	?	?
F350	4x4	1993	All	No	All	All	All	All		1379	2,10	?	?	?	?	?	?	?
F350	4x4	1994	All	No	All	All	All	All		1379	2,10	?	?	?	?	?	?	?
F350	4x4	1995	All	No	All	All	All	All		1379	2,10	?	?	?	?	?	?	?
F350	4x4	1996	All	No	All	All	All	All		1379	2,10	?	?	?	?	?	?	?

- Notes:**
- Ballast amounts are based on a "Representative Vehicle," defined in the vehicle selection guide instructions, and must be modified for all other configurations for axle and GVWR compliance.
  - Recommended snowplow prep package whenever available.

- May require bumper or air dam notching.
- Requires front air bags.

# 1996 & Prior Ford

## Section 3 MVP® & MVP PLUS™ Blades

<b>MVP®</b>		<b>MVP PLUS™</b>				
8'-6" STEEL	7'-6" STEEL	7'-6" POLY	8'-6" STEEL	8'-6" POLY	9'-6" STEEL	9'-6" POLY
<b>IUMVP85</b>	<b>IUTHVPP75</b>	<b>IUTHVPP75</b>	<b>IUTHVPP85</b>	<b>IUTHVPP85</b>	<b>IUTHVPP95</b>	<b>IUTHVPP95</b>
Blade Assembly	63910	44475	44575	44485	44585	44495
AQ&L Assembly Box 1	63910					
AQ&L Assembly Box 2	67951-2					
Hydraulic Kit	64777			44225		
Light Kit	28800					
Choose a Joystick Control or Hand-Held Control	96369			96700		
	96462			96600		

Model	Year	Body Style	DRW	Box Option	Engine Type	Min F G A W R	Min R G A W R	Min G V W R	Harness Kit	UltraMount® system		Plow	Blade Assembly	AQ&L Assembly Box 1	AQ&L Assembly Box 2	Hydraulic Kit	Light Kit	Choose a Joystick Control or Hand-Held Control		
										Mount Kit	Notes									
F-SUPERDUTY	4x2	1980	All	No	All	All	All	10000	2B use 8439 or HB1 use 8436	63710-1	24	?	---	---	---	---	---	---	---	
F-SUPERDUTY	4x2	1981	All	No	All	All	All	10000		63710-1	24	?	---	---	---	---	---	---	---	
F-SUPERDUTY	4x2	1982	All	No	All	All	All	10000		63710-1	24	?	---	---	---	---	---	---	---	
F-SUPERDUTY	4x2	1983	All	No	All	All	All	10000		63710-1	24	?	---	---	---	---	---	---	---	
F-SUPERDUTY	4x2	1984	All	No	All	All	All	10000		63710-1	24	?	---	---	---	---	---	---	---	
F-SUPERDUTY	4x2	1985	All	No	All	All	All	10000		63710-1	24	?	---	---	---	---	---	---	---	---
F-SUPERDUTY	4x2	1986	All	No	All	All	All	10000		63710-1	24	?	---	---	---	---	---	---	---	---
F-SUPERDUTY	4x2	1987	All	No	All	All	All	10000		63710-1	24	?	---	---	---	---	---	---	---	---
F-SUPERDUTY	4x2	1988	All	No	All	All	All	10000		63710-1	24	?	---	---	---	---	---	---	---	---
F-SUPERDUTY	4x2	1989	All	No	All	All	All	10000		63710-1	24	?	---	---	---	---	---	---	---	---
F-SUPERDUTY	4x2	1990	All	No	All	All	All	10000	63710-1	24	?	---	---	---	---	---	---	---	---	
F-SUPERDUTY	4x2	1991	All	No	All	All	All	10000	63710-1	24	?	---	---	---	---	---	---	---	---	
F-SUPERDUTY	4x2	1992	All	No	All	All	All	10000	HB5 use 8436	1379	2,10	?	?	?	?	?	?	?	?	
F-SUPERDUTY	4x2	1993	All	No	All	All	All	10000		1379	2,10	?	?	?	?	?	?	?	?	?
F-SUPERDUTY	4x2	1994	All	No	All	All	All	10000		1379	2,10	?	?	?	?	?	?	?	?	?
F-SUPERDUTY	4x2	1995	All	No	All	All	All	10000		1379	2,10	?	?	?	?	?	?	?	?	?
F-SUPERDUTY	4x2	1996	All	No	All	All	All	10000		1379	2,10	?	?	?	?	?	?	?	?	?

- Notes:**
- Ballast amounts are based on a "Representative Vehicle," defined in the vehicle selection guide instructions, and must be modified for all other configurations for axle and GVWR compliance.
  - Recommended snowplow prep package whenever available.

- May require bumper or air dam notching.
- Requires front air bags.





# 1996 & Prior Toyota

## Section 1 Suburbanite™ & MIDWEIGHT™ Blades

Suburbanite™		UltraMount	
Suburbanite™		MIDWEIGHT™	
6'-8" POLY	7'-4" POLY	7'-6" STEEL	7'-6" POLY
<b>SUB68</b>	<b>SUB74</b>	<b>IUTH75</b>	<b>IUTHY75</b>
Blade Assembly	27546	27548	64340
AQ&L Assembly Box 1	27550	64330	64336
AQ&L Assembly Box 2	n/a	67992	64620
Hydraulic Kit	27516	64620	28800
Light Kit	64100	28800	56369
Choose a Joystick Control or Hand-Held Control	56369	56369	56462
	56462	56462	

Model	Year	Body Style	DRW	Box Option	Engine Type	Min F G A W R	Min R G A W R	Min S V W R	Harness Kit	Personal Plow system	Ballast Guidelines, lbs (1)		UltraMount® system		Ballast Guidelines, lbs (1)		
											Mount Kit	Notes	Mount Kit	Notes	Mount Kit	Notes	
TACOMA	4x4	1995	All	No	All	All	All	All	2B use 8439	2313	8	?	?	n/a	---	---	---
TACOMA	4x4	1996	All	No	All	All	All	All		2313	8	?	?	n/a	---	---	---

- Notes:**
- Ballast amounts are based on a "Representative Vehicle," defined in the vehicle selection guide instructions, and must be modified for all other configurations for axle and GVWR compliance.
  - These Snowplows Are For Personal/Homeowner Use Only.

## HEADLAMP REFERENCE GUIDE

**NOTE:** The lamp type is usually embossed in the headlamp lens.

**NOTE:** Blue ground wires may be LT or DK BLU, w/ or w/o WHT stripe, depending on harness.

Headlamp Type	Bulb Type	Headlamp Type	Bulb Type
LF	H4703	2E1	H6545
UF	H4701	H13	9008
1A1	H4651	HB1	9004
2A1	H4652(GMC/Chevy)	HB2	9003
2A1	H4656 (Mitsubishi)	HB3	9005
2B1	H6054	HB4	9006
2D1	H6024	HB5	9007

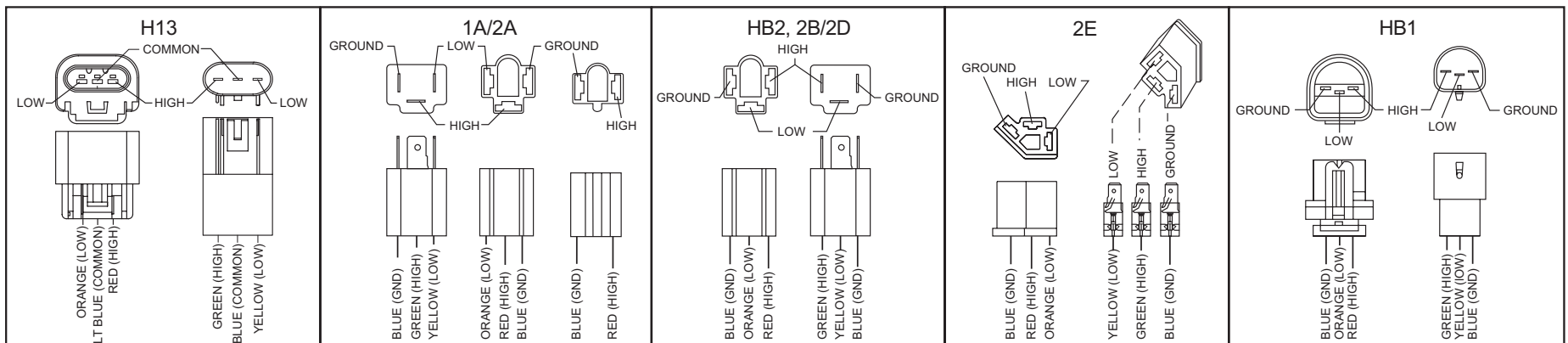
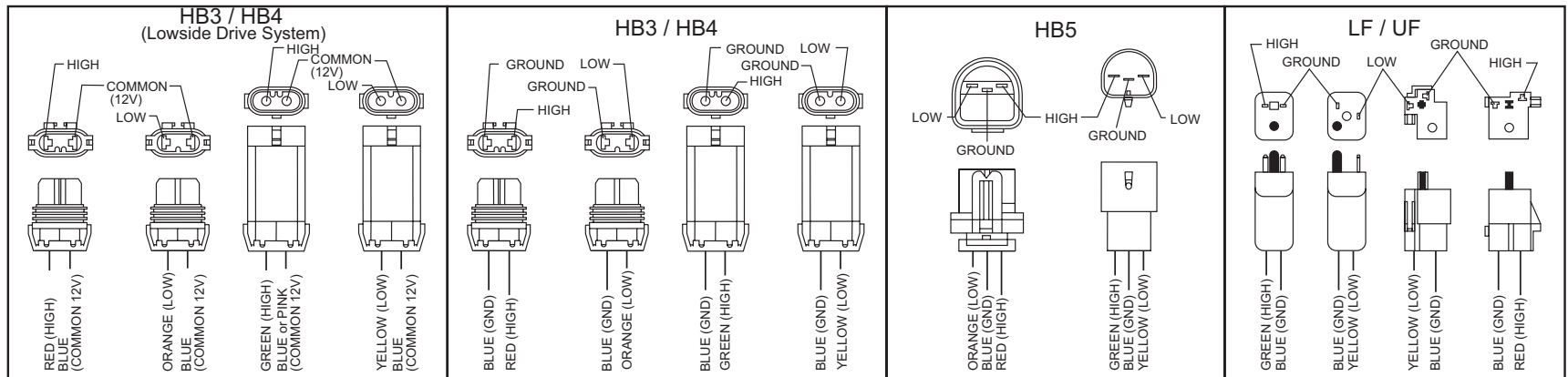

## WEIGHT AND DIMENSIONAL CHARTS

Plows and Accessories Information										
Plows		Accessories – Part Number (Effective Added Weight in lb)								Var.
Size	Wt. (lb)	HD Poly Deflector	Rubber Deflector	Cutting Edge 1/2"	Back Drag Edge 1/4"	Wing Kit	Shoes	Curb Guard	Dolly Wheel	Z (in)
SUB68	239	—	—	—	—	—	27710 (5.7)	—	—	20.4
SUB74	257	—	—	—	—	—	27710 (5.7)	—	—	20.8
IUTM75	540	63700 (19.1)	62123 (29.6)	—	64758 (47.0)	—	64392 (21.1)	44404 (61.3)	—	20.4
IUTMY75	532	63700 (19.1)	62123 (29.6)	—	64758 (47.0)	—	64392 (21.1)	44404 (61.6)	—	20.3
IUTP75	682	63700 (19.2)	62123 (29.7)	49346 (25.8)	64758 (47.0)	—	—	44403 (63.8)	—	20.8
IUTPY75	719	—	—	49350 (24.8)	64758 (47.0)	—	—	44403 (58.4)	—	22.7
IUTP80	699	63670 (20.1)	62530 (33.8)	49347 (27.4)	66892 (60.6)	—	—	44403 (62.3)	—	21.3
IUTPY80	727	—	—	49351 (26.9)	66892 (60.6)	—	—	44403 (59.0)	—	22.5
IUTP85	715	63670 (21.1)	62220 (35.5)	49348 (28.8)	66999 (63.5)	—	—	44403 (61.7)	—	21.5
IUTPP75	789	63700 (12.4)	62123 (28.9)	—	64758 (59.7)	64410 (90)	—	44404 (41.2)	—	26.1
IUTPP80	805	63670 (13.3)	62530 (32.2)	—	66892 (63.2)	64410 (90)	—	44404 (40.7)	—	26.4
IUTPP85	821	63670 (14.2)	62220 (35.5)	—	66999 (66.2)	64410 (90)	—	44404 (40.3)	—	26.7
IUTPP90	837	63670 (15.0)	62220 (37.1)	—	66991 (69.2)	64410 (90)	—	44404 (39.8)	—	27.0
IMVP85	899	—	—	28409 (41.6)	—	—	—	—	—	24.0
IUTMVPP75	827	—	44278 (*)	44284 (*)	—	44276 (*)	44277 (*)	44404 (25.2)	—	18.4
IUTMVPPY75	799	—	44278 (*)	44284 (*)	—	44276 (*)	44277 (*)	44404 (25.5)	—	18.4
IUTMVPP85	880	—	44279 (*)	44285 (*)	—	44276 (*)	44277 (*)	44404 (24.0)	—	18.3
IUTMVPPY85	847	—	44279 (*)	44285 (*)	—	44276 (*)	44277 (*)	44404 (24.1)	—	18.3
IUTMVPP95	1006	—	44280 (*)	—	—	44276 (*)	44277 (*)	44404 (22.8)	—	18.8
IUTMVPPY95	964	—	44280 (*)	—	—	44276 (*)	44277 (*)	44404 (23.5)	—	18.8
IUHW90	1048	—	62220 (37.8)	—	—	—	—	44404 (33.7)	62430 (24.8)	33.0
IUHW10	1106	—	62124 (45.8)	—	—	—	—	44404 (33.1)	62430 (24.8)	33.6
—	—	UltraMount to UniMount Conversion Kit 27170 (94.0)								Varies

\* This part number is currently not available for purchase, thus finalized weights have not been established. Once weights are established and product is available, finalized weights will be published.

Mount Information							
Mount	Weight (lb)	X (in)	Y (in)	Mount	Weight (lb)	X (in)	Y (in)
<b>Suburbanite™ Mounts</b>							
1203	34.0	27.0	6.0	2313	30.0	27.0	5.0
1213-1	23.0	26.0	6.0	3713-1	20.0	26.0	5.0
1223	40.0	28.0	7.0	3723	35.0	21.4	5.0
1233	34.0	32.0	7.1	31303	43.0	27.9	4.8
1503	26.0	27.0	6.0	31543	20.0	28.5	7.1
1523	26.0	30.0	6.0	32323	36.0	30.0	7.3
1533-1	31.0	26.0	5.0	33903	45.0	31.0	7.8
2303	41.0	29.0	6.0	42021	37.0	29.0	8.0
<b>UniMount® and UltraMount® Mounts</b>							
1369	80.0	32.9	8.3	63760	40.0	30.0	8.0
1379	83.0	32.9	8.3	63883-2	47.0	37.0	6.9
3249	65.0	30.4	9.8	63900	87.0	29.6	12.5
3919	47.0	30.1	8.5	64110	115.0	38.0	10.0
33109	110.0	38.0	7.0	64500	33.0	32.5	8.9
33259	43.0	33.5	10.8	67810	44.0	35.1	8.7
33559	115.0	38.0	10.0	67865	41.0	31.3	7.6
33929	39.0	32.5	8.1	67960-1	34.0	29.1	7.6
30999	40.0	33.5	8	67980	51.0	35.0	8.5
62275	Varies			67981-2	54.0	32.4	11.4
63710-1	87.0	27.8	5.7	67982	69.0	30.4	9.0

**NOTE: The addition of accessories to a snowplow or vehicle will require additional ballast above any amount published in this guide in order to maintain FMVSS compliance. Completed vehicle with additional accessories shall not exceed GVWR or GAWR.**

**NOTE: An abbreviation key is on page 2.**

**NOTE: See next page for variable definitions.**

## DIMENSIONAL DIAGRAM

### Variables:

X = Distance from center of front axle to receiver pin

Y = Distance from receiver pin to CG of mount.

Z = Distance from receiver pin to CG of snowplow.

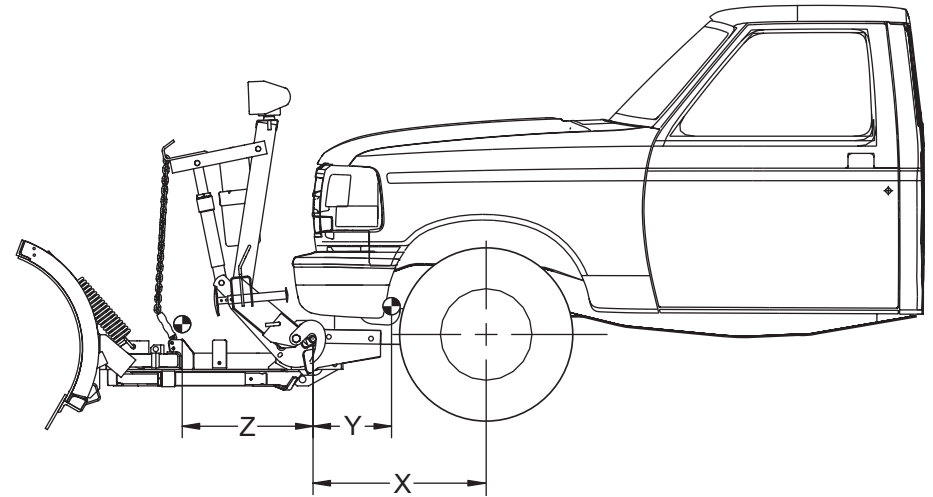

**Example:** Weight that one would use if they had an IUTP75 with the poly deflector and a 1/2" cutting edge.

The weight of the plow alone with no accessories would be 682 lb with its center of gravity 20.8 in from the coupling point. To add the weight of the accessories, look in the row with the IUTP75 blade to find the effective poly deflector weight of 19.2 lb and the effective cutting edge weight of 25.8 lb.

The total weight of the blade and accessories will be:

$$\begin{array}{r}
 682.0 \\
 19.2 \\
 + 25.8 \\
 \hline
 727.0
 \end{array}$$

with its center of gravity still at 20.8 in from the coupling point

ALWAYS comply with the vehicle manufacturer's stated gross vehicle and axle weight ratings (found on

the driver-side door jamb of the vehicle) and front and rear weight distribution ratio with the snowplow installed. In some cases, rear ballast may be required to achieve these requirements.

Available vehicle capacities for aftermarket equipment and components can be determined by using the above information along with information provided by the vehicle manufacturer's Body Builder Guides. Follow all requirements and recommendations as stated by vehicle manufacturer.

---

**NOTE: An abbreviation key is on page 2.**

---

# VEHICLE AND PLOW APPLICATION INQUIRY SHEET



**Western Products**  
7777 North 73<sup>rd</sup> Street  
Milwaukee, WI 53223

Telephone (414) 354-2310  
Fax (414) 354-6664

<b>DISTRIBUTOR</b>		<b>TEL</b>
		<b>FAX</b>

<b>CUSTOMER</b>		
<b>VIN</b>		<b>DATE BUILT</b>

<b>SELECT MOUNT TYPE</b>	<input type="checkbox"/> UniMount <sup>®</sup>	<input type="checkbox"/> UltraMount <sup>®</sup>	<input type="checkbox"/> Conversion Kit
	<input type="checkbox"/> Suburbanite <sup>™</sup>		

## VEHICLE INFORMATION

<b>YEAR</b>			
<b>MAKE</b>			
<b>MODEL</b>			
<b>DRIVE TRAIN</b>	<input type="checkbox"/> 4x2 (over 10,000 lb. GVW only)	<input type="checkbox"/> 4x4	<input type="checkbox"/> ALL WHEEL <input type="text"/> OTHER
<b>DRW</b> (Dual Rear Wheels)	<input type="checkbox"/> YES	<input type="checkbox"/> NO	
<b>BODY STYLE</b>	<input type="checkbox"/> REG CAB	<input type="checkbox"/> EXT CAB	<input type="text"/> OTHER
<b>BOX OPTION (S)</b>	<input type="checkbox"/> DUMP BOX	<input type="checkbox"/> STAKE BED	<input type="text"/> OTHER
<b>ENGINE TYPE</b>			
<b>GFAWR</b>			
<b>GRAWR</b>			
<b>GVWR</b>			

HORIZONTAL DISTANCE DESCRIPTION

<b>L31</b>	DRIVERS hip point; in MIDDLE position, to Centerline of FRONT axle	(in.)
<b>L101</b>	Between axles (Wheelbase)	(in.)
<b>L104</b>	Middle of FRONT bumper to centerline of FRONT axle	(in.)
	Middle of ballast location to centerline of REAR axle	(in.)

**VEHICLE WEIGHT (TRUCK MUST BE WEIGHED COMPLETE AND EMPTY (-) OCCUPANTS, PLOW & MOUNT)**

FRONT (lb.)	REAR (lb.)

**FUEL TANKS (ONLY NEEDED IF WEIGHED VEHICLE NOT FULLY FUELED)**

	LEVEL (see below)	CAPACITY (gal.)	LOCATION FROM AXLE TO CENTER OF TANK(in.)
<b>FRONT OF AXLE</b>			
<b>REAR OF AXLE</b>			

FUEL LEVEL (EMPTY = 0, HALF = 1/2, FULL = 1)

**THIS FORM *MUST* BE COMPLETED IN ITS ENTIRETY. ANY FORMS CONTAINING INCOMPLETE INFORMATION WILL NOT BE CONSIDERED. PLEASE RETURN VIA FAX (414) 354-6664.**

Western Products or the vehicle manufacturer may require or recommend optional equipment for snow removal.  
See the WESTERN<sup>®</sup> Selection List for additional product information.

## UltraMount® SYSTEM TO UniMount® SYSTEM CONVERSION KIT (PN 27170)

### ⚠ WARNING

Conversion kit use is limited to vehicles up to 19,500 lb GVWR.

### ⚠ WARNING

Do not exceed GVWR or GAWR, including blade and ballast. The rating label is found on the driver-side vehicle door cornerpost.

This easy to use UltraMount system to UniMount system conversion kit enables you to attach a UniMount plow to a vehicle equipped with an UltraMount mount.

Simply remove the receivers from your UltraMount system mount, and pin the conversion plate in place. This accessory is perfect for customers with multiple snowplows, providing their fleet with versatility while changing to the UltraMount system.

This new kit is also ideal for transferring an old UniMount plow to a new truck. As new trucks are released, we will develop only new UltraMount mounts for these plow applications. This will allow the customer to transfer an existing UniMount plow to the late model vehicle. In addition, when customers are ready to replace their old UniMount plow, the truck will already have the mount and wiring for an UltraMount plow.

**TO QUALIFY THE VEHICLE AND DETERMINE BALLAST, YOU MUST FILL OUT THE VEHICLE AND PLOW APPLICATION INQUIRY SHEET.**

---

**NOTE: When ballast is required, it should be secured behind the rear wheels in a manner which prevents it from sliding during normal driving. Western Products offers an options ballast retainer kit (PN 62849) for this purpose.**

---

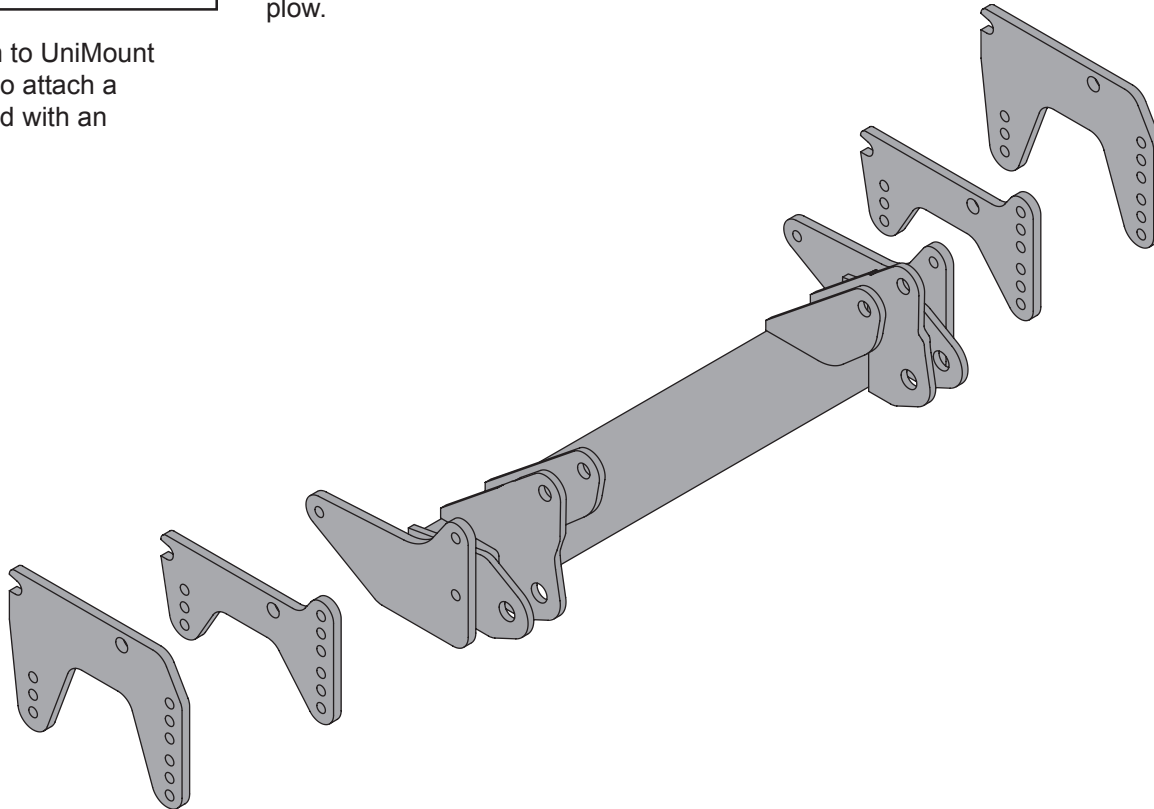



WESTERN PRODUCTS  
P.O. BOX 245038  
MILWAUKEE, WI 53224-9538

 A DIVISION OF DOUGLAS DYNAMICS, L.L.C.

Western Products reserves the right under its product improvement policy to change construction or design details and furnish equipment when so altered without reference to illustrations or specifications used. Western Products or the vehicle manufacturer may require or recommend optional equipment for snow removal. Do not exceed vehicle ratings with a snowplow. Western Products offers a limited warranty for all snowplows and accessories. See separately printed page for this important information. The following are registered (®) or unregistered (™) trademarks of Douglas Dynamics, L.L.C.: MIDWEIGHT™, MVP®, MVP PLUS™, POLY PRO-PLOW®, PRO-PLOW®, PRO PLUS®, Suburbanite™, UltraMount®, UniMount®, WESTERN®.

**Printed in U.S.A.**