



2006

MODEL YEAR VEHICLES

SELECTION LIST

Isolation Module System Snowplows



Lit. No. 64310
June 1, 2006
Revision 02

This document supersedes all editions with an earlier date.

TABLE OF CONTENTS

About the <i>Selection List</i>	3	Nissan Attachment Kits	38
Selection Example	4	Toyota Attachment Kits	39
Chevy/GMC Attachment Kits	5	Headlamp Reference Guide	40
Dodge Attachment Kits	10	Weight and Dimensional Charts	41
Ford Attachment Kits	14	Dimensional Diagram	42
International Attachment Kits	34	Ballast Inquiry Sheet	43
Jeep Attachment Kits	35	UltraMount® System to UniMount® System	
Mitsubishi Attachment Kits	36	Conversion Kit	44

ABBREVIATION KEY			
---	No Application	NTEA	National Truck Equipment Association
4WS	Four Wheel Steering	OEM	Original Equipment Manufacturer
4x2	Two Wheel Drive	OHC	Overhead Cam
4x4	Four Wheel Drive	PN	Part Number
A,Q&L	A-Frame, Quadrant & Lift Frame	RGAWR	Rear Gross Axle Weight Rating
AWD	All Wheel Drive	SL	Selection List
CG	Center of Gravity	SU-2DR	Two Door Sport/Utility Vehicle
Chassis	Chassis Cab or Cab Chassis	SU-4DR	Four Door Sport/Utility Vehicle
DIA	Diameter	SUB	Suburbanite™ Snowplow
DRW	Dual Rear Wheels	UHW	UniMount® Heavy Weight Snowplow
Ext Cab	Extended Cab Vehicle	UTM	UltraMount® MIDWEIGHT™ Snowplow
FFV	Flex Fuel Vehicle	UTMY	UltraMount MIDWEIGHT Poly Snowplow
FGAWR	Front Gross Axle Weight Rating	UTMVP	UltraMount MVP® Snowplow
FMVSS	Federal Motor Vehicle Safety Standards	UTMVPP	UltraMount MVP PLUS Snowplow
GVWR	Gross Vehicle Weight Rating	UTMVPPY	UltraMount Poly MVP PLUS Snowplow
HD	Heavy Duty	UTP	UltraMount PRO-PLOW® Snowplow
HO	High Output	UTPP	UltraMount PRO PLUS® Snowplow
HYD	Hydraulic	UTPY	UltraMount POLY PRO-PLOW Snowplow
MIN	Minimum	w/	With
MVP	MultiPosition V-Plow	w/o	Without
MVPP	MVP PLUS™ Snowplow		

⚠ WARNING

New untitled vehicle installation of a snowplow requires National Highway Traffic Safety Administration altered vehicle certification labeling. Installer to verify that selected snowplow and ballast, if required, do not exceed GVWR or GAWR rating label and complies with FMVSS.

⚠ WARNING

Do not exceed GVWR or GAWR, including blade and ballast. The rating label is found on the driver-side vehicle door cornerpost.

ABOUT THE SELECTION LIST

The *Selection List (SL)* is designed to help you determine the appropriate snowplow components for a particular snowplow vehicle application. The information published in this guide is based on Federal Motor Vehicle Safety Standards (FMVSS) and a "representative" snowplow vehicle as defined in this guide. The vehicle includes a combined weight of 300 lb for occupants in the front seat location.

This *SL* is for specific model year vehicles only and is listed on the front cover of this guide. This guide should be saved for future reference. New selection guides will be published for the upcoming model year and so on. The instructions on page 4 explain how to use the *Selection List*.

The "Representative Vehicle"

Knowing that today's snowplow vehicles come in a variety of sizes and configurations (such as wheel base, engine size, and handling packages), Western Products has defined a "representative vehicle" that contains the options most likely to appear on a typical snowplow application. The "representative vehicle" includes the following options:

- 4X4 Drivetrain (unless noted)
- Spare Tire & Wheel
- Automatic Transmission
- Rear Bumper
- Air Conditioning
- Full Fluids

NOTE: If the vehicle in question does not match a vehicle listing in the *Selection List*, or has options that differ from the "Representative Vehicle" as defined earlier, the ballast inquiry sheet must be filled out and submitted in order to determine plow availability and correct ballast amounts to maintain FMVSS compliance. Completed vehicle at no time shall exceed GVWR or GAWR.

Snowplow Product

Snowplows are considered motor vehicle equipment. The installer is ultimately responsible for determining and correctly labeling the vehicle with the addition of snowplow selection. No product selected and installed shall render inoperative the vehicle's safety compliance.

Product Changes

All information is as accurate as we can determine but is subject to revision with additional or more complete information. Western Products reserves the right under its product improvement policy to change construction or design details and furnish equipment when so altered without reference to illustrations or specifications used. Western Products or the vehicle manufacturer may require or recommend optional equipment for snow removal.

Ballast

When ballast is required it must be secured behind the rear wheels in a manner which prevents it from sliding during normal driving. Ballast shall not exceed 1000 lb.

Western Products offers an optional ballast retainer kit (62849) for this purpose.

HOW TO USE THE SELECTION LIST

Selection Example:

Acme Motors 15000 VX with UltraMount® System

- Go to the section for the appropriate manufacturer.
- Go to the subsection for the desired snowplow:
 - **Section 1:** Suburbanite™ & MIDWEIGHT™ snowplows
 - **Section 2:** PRO-PLOW®, PRO PLUS® & Heavy Weight snowplows
 - **Section 3:** MVP® & MVP PLUS™ snowplows
- Starting at the left-most column, find the **model** and appropriate configuration for the vehicle. In this case, 4X4, Regular Cab, 6.5 ft. box, 5.3L V8 engine, 3925 Min. FGAWR.

- Locate the **harness kit** part number for this vehicle: 27780. See Headlamp Reference Guide in the back of the Selection List for more information.
- Locate the **mount** for this vehicle: 1523 for Suburbanite™ system or 67960-1 for UltraMount® system. Refer to any footnotes concerning conditions or requirements. For this example the UltraMount system is selected and has five footnotes: 1, 2, 3, 4 and 6.
- Locate the acceptable **blades** at the top of the table. Only those blades with ballast weights listed are valid applications. Three short dashes (—) indicates an invalid application. A question mark (?) indicates a ballast inquiry sheet must be completed.

- For this example, there are two acceptable UltraMount blades. Choose the 7'-6" Steel MIDWEIGHT blade. This blade requires 350 lb of ballast.
- To order components for a complete snowplow package, read down from the top of the selected blade column for appropriate part numbers. Be sure to select *one* control, either joystick or hand-held. For this example, the part numbers would be:
 - 64340 (blade assembly)
 - 64336 (A, Q & L assembly Box 1)
 - 67992 (A, Q & L assembly Box 2)
 - 64620 (hydraulic kit)
 - 28800 (light kit)
 - 56369 or 56462 (control)
 - 27780 (harness kit, from Step 4)
 - 67960-1 (mount, from Step 5 – *must match blade*)

2006 Acme Motors

Section 1 Suburbanite™ & MIDWEIGHT™ blades

Model	Body Style	DRW	Box Option	Engine Type	Min FGAWR	Min RGAWR	Min GVWR	Harness Kit	Personal Plow system		Ballast Guidelines, lbs (1)	UltraMount® system		Ballast Guidelines, lbs (1)			
									Mount Kit	Notes		Mount Kit	Notes				
15000 RS	4x4	Reg Cab	No	6.5 Box	4.3L V6	3925	3750	6400	HB3/HB4 use	1523	3,6,8	---	100	67960-1	2,3,4,6	350	300
15000 TU	4x4	Reg Cab	No	6.5 Box	4.8L V8	3925	3750	6400		1523	3,6,8	---	150	67960-1	2,3,4,6	400	400
15000 VX	4x4	Reg Cab	No	6.5 Box	5.3L V8	3925	3750	6400		1523	3,6,8	---	100	67960-1	2,3,4,6	350	350

Suburbanite™		
6'-8" POLY	7'-4" POLY	
SUB68	SUB74	
Blade Assembly	27546	27548
AQ&L Assembly Box 1	27550	
AQ&L Assembly Box 2	n/a	
Hydraulic Kit	27516	
Light Kit	64100	
Choose a Joystick Control or Hand-Held Control	56369	
	56462	

UltraMount™		
MIDWEIGHT™		
7'-6" STEEL	7'-6" POLY	
IUTH75	IUTHY75	
Blade Assembly	64340	64330
AQ&L Assembly Box 1	64336	
AQ&L Assembly Box 2	67992	
Hydraulic Kit	64620	
Light Kit	28800	
Choose a Joystick Control or Hand-Held Control	56369	
	56462	

- Notes:**
- Ballast amounts are based on a "Representative Vehicle," defined in the vehicle selection guide instructions, and must be modified for all other configurations for axle and GVWR compliance.
 - Recommended snowplow prep package whenever available.
 - Requires bumper notching.

- Recommended Z85 suspension.
- All New Style Only (2nd # in model # is 5 not 0) example: K15903. Refer to label in glove box for model number.
- These Snowplows Are For Personal/Homeowner Use Only.

2006 Chevy/GMC

Section 1 Suburbanite™ & MIDWEIGHT™ Blades

	
Suburbanite™	
6'-8" POLY	7'-4" POLY
SUB68	SUB74
Plow	
Blade Assembly	
27546	27548
AQ&L Assembly Box 1	
27550	
AQ&L Assembly Box 2	
n/a	
Hydraulic Kit	
27516	
Light Kit	
64100	
Choose a Joystick Control	
56369	
or Hand-Held Control	
56462	

	
MIDWEIGHT™	
7'-6" STEEL	7'-6" POLY
IUTH75	IUTHY75
64340	64330
64336	
67992	
64620	
28800	
56369	
56462	

Model	Body Style	DRW	Box Option	Engine Type	Min F G A W R	Min R G A W R	Min G V W R	Harness Kit	Personal Plow system		Ballast Guidelines, lbs (1)	UltraMount® system		Ballast Guidelines, lbs (1)			
									Mount Kit	Notes		Mount Kit	Notes				
TRAILBLAZER/ENVOY	4x4	SU-4DR	No	---	4.2L I6	2950	3200	5750	HB3/HB4 use 28028	1533-1	8	100	200	n/a	---	---	---
TRAILBLAZER EXT/ENVOY XL	4x4	SU-4DR	No	---	5.3L V8	3200	3400	6400		1533-1	8	0	0	n/a	---	---	---
AVALANCHE 1500	4x4	SU-4DR	No	---	5.3L V8	3800	4000	7000		1523	3,6,8	---	0	67960-1	2,3,4,6	150	100
TAHOE/YUKON 1500	4x4	SU-4DR	No	---	5.3L V8	3350	3900	6800		1523	3,6,8	---	0	67960-1	2,3,4,6	---	---
TAHOE/YUKON 1500	4x4	SU-4DR	No	---	5.3L BIF	3350	3900	6800		1523	3,6,8	---	0	67960-1	2,3,4,6	---	---
YUKON DENALI	AWD	SU-4DR	No	---	6.0L V8	3550	4000	7000		1523	3,6,8	---	0	67960-1	2,3,4,6	600	550
YUKON XL DENALI	AWD	SU-4DR	No	---	6.0L V8	3600	4000	7200		1523	3,6,8	---	0	67960-1	2,3,4,6	850	800
SUBURBAN/YUKON XL 1500	4x4	SU-4DR	No	---	5.3L V8	3450	4000	7200		1523	3,6,8	---	0	67960-1	2,3,4,6	---	---
SUBURBAN/YUKON XL 1500	4x4	SU-4DR	No	---	6.0L V8	3450	4000	7200		1523	3,6,8	---	0	67960-1	2,3,4,6	---	---
AVALANCHE 2500	4x4	SU-4DR	No	---	8.1L V8	4380	5500	8600		n/a	---	---	---	67981-2	---	550	500
SUBURBAN/YUKON XL 2500	4x4	SU-4DR	No	---	6.0L V8	4180	5500	8600		n/a	---	---	---	67981-2	---	0	0
COLORADO/CANYON Z71	4x4	Reg Cab	No	6.1 Box	2.8L I4	2753	2896	5150		31543	3,8	50	50	n/a	---	---	---
COLORADO/CANYON Z71	4x4	Reg Cab	No	6.1 Box	3.5L I5	2753	2896	5150		31543	3,8	50	100	n/a	---	---	---
COLORADO/CANYON Z71	4x4	Crew Cab	No	5.0 Box	2.8L I4	2753	2896	5300		31543	3,8	0	50	n/a	---	---	---
COLORADO/CANYON Z71	4x4	Crew Cab	No	5.0 Box	3.5L I5	2753	2896	5300		31543	3,8	200	300	n/a	---	---	---
COLORADO/CANYON Z85	4x4	Reg Cab	No	6.1 Box	2.8L I4	2753	2896	5150		31543	3,8	50	50	n/a	---	---	---
COLORADO/CANYON Z85	4x4	Reg Cab	No	6.1 Box	3.5L I5	2753	2896	5150		31543	3,8	50	100	n/a	---	---	---
COLORADO/CANYON Z85	4x4	Crew Cab	No	5.0 Box	2.8L I4	2753	2896	5300		31543	3,8	0	0	n/a	---	---	---
COLORADO/CANYON Z85	4x4	Crew Cab	No	5.0 Box	3.5L I5	2753	2896	5300		31543	3,8	150	250	n/a	---	---	---
K1500 SILV/SIERRA	4x4	Reg Cab	No	6.5 Box	4.3L V6	3925	3750	6400		1523	3,6,8	---	100	67960-1	2,3,4,6	350	300
K1500 SILV/SIERRA	4x4	Reg Cab	No	6.5 Box	4.8L V8	3925	3750	6400		1523	3,6,8	---	150	67960-1	2,3,4,6	400	400
K1500 SILV/SIERRA	4x4	Reg Cab	No	6.5 Box	5.3L V8	3925	3750	6400		1523	3,6,8	---	100	67960-1	2,3,4,6	350	350
K1500 SILV/SIERRA	4x4	Reg Cab	No	6.5 Box	5.3L BIF	3925	3750	6400		1523	3,6,8	---	150	67960-1	2,3,4,6	350	350
K1500 SILV/SIERRA	4x4	Reg Cab	No	8.0 Box	4.3L V6	3925	3750	6400		1523	3,6,8	---	100	67960-1	2,3,4,6	350	350
K1500 SILV/SIERRA	4x4	Reg Cab	No	8.0 Box	4.8L V8	3925	3750	6400		1523	3,6,8	---	150	67960-1	2,3,4,6	400	400
K1500 SILV/SIERRA	4x4	Reg Cab	No	8.0 Box	5.3L V8	3925	3750	6400		1523	3,6,8	---	150	67960-1	2,3,4,6	400	350
K1500 SILV/SIERRA	4x4	Reg Cab	No	8.0 Box	5.3L BIF	3925	3750	6400		1523	3,6,8	---	150	67960-1	2,3,4,6	400	400
K1500 SILV/SIERRA	4x4	Ext Cab	No	6.5 Box	4.8L V8	3925	3750	6700		1523	3,6,8	---	150	67960-1	2,3,4,6	350	350
K1500 SILV/SIERRA	4x4	Ext Cab	No	6.5 Box	4.8L V8	3925	3750	6400		1523	3,6,8	---	150	67960-1	2,3,4,6	350	350
K1500 SILV/SIERRA	4x4	Ext Cab	No	6.5 Box	5.3L V8	3925	3750	6700		1523	3,6,8	---	100	67960-1	2,3,4,6	350	300
K1500 SILV/SIERRA	4x4	Ext Cab	No	6.5 Box	5.3L V8	3925	3750	6400		1523	3,6,8	---	50	67960-1	2,3,4,6	300	300
K1500 SILV/SIERRA	4x4	Ext Cab	No	6.5 Box	5.3L V8	3925	3750	6400		1523	3,6,8	---	100	67960-1	2,3,4,6	350	300
K1500 SILV/SIERRA	4x4	Ext Cab	No	6.5 Box	5.3L BIF	3925	3750	6700		1523	3,6,8	---	150	67960-1	2,3,4,6	350	350
K1500 SILV/SIERRA	4x4	Ext Cab	No	6.5 Box	5.3L BIF	3925	3750	6400		1523	3,6,8	---	150	67960-1	2,3,4,6	350	350

- Notes:**
- Ballast amounts are based on a "Representative Vehicle," defined in the vehicle selection guide instructions, and must be modified for all other configurations for axle and GVWR compliance.
 - Recommended snowplow prep package whenever available.
 - Requires bumper notching.

- Recommended Z85 suspension.
- All New Style Only (2nd # in model # is 5 not 0) example: K15903. Refer to label in glove box for model number.
- These Snowplows Are For Personal/Homeowner Use Only.

2006 Chevy/GMC

Section 1 Suburbanite™ & MIDWEIGHT™ Blades

 Suburbanite™	
6'-8" POLY	7'-4" POLY
SUB68	SUB74
Plow Blade Assembly	27546 27548
AQ&L Assembly Box 1	27550
AQ&L Assembly Box 2	n/a
Hydraulic Kit	27516
Light Kit	64100
Choose a Joystick Control	56369
or Hand-Held Control	56462

 MIDWEIGHT™	
7'-6" STEEL	7'-6" POLY
IUTH75	IUTHY75
64340	64330
64336	
67992	
64620	
28800	
56369	
56462	

Model	Body Style	DRW	Box Option	Engine Type	Min F G A W R	Min R G A W R	Min G V W R	Harness Kit	Personal Plow system		Ballast Guidelines, lbs (1)	UltraMount® system		Ballast Guidelines, lbs (1)		
									Mount Kit	Notes		Mount Kit	Notes			
K1500 SILV/SIERRA	4x4	Ext Cab	No	8.0 Box	4.8L V8	3925	4000	6900	1523	3,6,8	---	150	67960-1	2,3,4,6	450	400
K1500 SILV/SIERRA	4x4	Ext Cab	No	8.0 Box	4.8L V8	3925	3750	6400	1523	3,6,8	---	150	67960-1	2,3,4,6	450	400
K1500 SILV/SIERRA	4x4	Ext Cab	No	8.0 Box	5.3L V8	3925	4000	6900	1523	3,6,8	---	150	67960-1	2,3,4,6	450	400
K1500 SILV/SIERRA	4x4	Ext Cab	No	8.0 Box	5.3L V8	3925	3750	6400	1523	3,6,8	---	150	67960-1	2,3,4,6	450	400
K1500 SILV/SIERRA	4x4	Ext Cab	No	8.0 Box	5.3L BIF	3925	4000	6900	1523	3,6,8	---	150	67960-1	2,3,4,6	500	450
K1500 SILV/SIERRA	4x4	Ext Cab	No	8.0 Box	5.3L BIF	3925	3750	6400	1523	3,6,8	---	150	67960-1	2,3,4,6	---	450
K1500 SILV/SIERRA	4x4	Crew Cab	No	5.8 Box	5.3L V8	3925	4000	7000	1523	3,6,8	---	50	67960-1	2,3,4,6	450	400
K1500HD SILV/SIERRA	4x4	Crew Cab	No	6.5 Box	6.0L V8	4410	6000	8600	n/a	---	---	---	67981-2	---	300	300
K2500HD SILV/SIERRA	4x4	Reg Cab	No	8.0 Box	6.0L V8	4800	6084	9200	n/a	---	---	---	67981-2	---	250	250
K2500HD SILV/SIERRA	4x4	Reg Cab	No	8.0 Box	6.0L V8	4500	6084	9200	n/a	---	---	---	67981-2	---	250	250
K2500HD SILV/SIERRA	4x4	Reg Cab	No	8.0 Box	6.6L D	4800	6084	9200	n/a	---	---	---	67981-2	---	450	450
K2500HD SILV/SIERRA	4x4	Reg Cab	No	8.0 Box	6.6L D	4500	6084	9200	n/a	---	---	---	67981-2	---	600	550
K2500HD SILV/SIERRA	4x4	Reg Cab	No	8.0 Box	8.1L V8	4800	6084	9200	n/a	---	---	---	67981-2	---	350	350
K2500HD SILV/SIERRA	4x4	Reg Cab	No	8.0 Box	8.1L V8	4500	6084	9200	n/a	---	---	---	67981-2	---	350	350
K2500HD SILV/SIERRA	4x4	Ext Cab	No	6.5 Box	6.0L V8	4800	6084	9200	n/a	---	---	---	67981-2	---	300	250
K2500HD SILV/SIERRA	4x4	Ext Cab	No	6.5 Box	6.0L V8	4670	6084	9200	n/a	---	---	---	67981-2	---	300	250
K2500HD SILV/SIERRA	4x4	Ext Cab	No	6.5 Box	6.6L D	4800	6084	9200	n/a	---	---	---	67981-2	---	450	450
K2500HD SILV/SIERRA	4x4	Ext Cab	No	6.5 Box	6.6L D	4670	6084	9200	n/a	---	---	---	67981-2	---	750	700
K2500HD SILV/SIERRA	4x4	Ext Cab	No	6.5 Box	8.1L V8	4800	6084	9200	n/a	---	---	---	67981-2	---	400	400
K2500HD SILV/SIERRA	4x4	Ext Cab	No	6.5 Box	8.1L V8	4670	6084	9200	n/a	---	---	---	67981-2	---	400	400
K2500HD SILV/SIERRA	4x4	Ext Cab	No	8.0 Box	6.0L V8	4800	6084	9200	n/a	---	---	---	67981-2	---	250	250
K2500HD SILV/SIERRA	4x4	Ext Cab	No	8.0 Box	6.0L V8	4670	6084	9200	n/a	---	---	---	67981-2	---	250	250
K2500HD SILV/SIERRA	4x4	Ext Cab	No	8.0 Box	6.6L D	4800	6084	9200	n/a	---	---	---	67981-2	---	400	400
K2500HD SILV/SIERRA	4x4	Ext Cab	No	8.0 Box	6.6L D	4670	6084	9200	n/a	---	---	---	67981-2	---	850	800
K2500HD SILV/SIERRA	4x4	Ext Cab	No	8.0 Box	8.1L V8	4800	6084	9200	n/a	---	---	---	67981-2	---	350	350
K2500HD SILV/SIERRA	4x4	Ext Cab	No	8.0 Box	8.1L V8	4670	6084	9200	n/a	---	---	---	67981-2	---	350	350
K2500HD SILV/SIERRA	4x4	Crew Cab	No	6.5 Box	6.0L V8	4800	6084	9200	n/a	---	---	---	67981-2	---	200	150
K2500HD SILV/SIERRA	4x4	Crew Cab	No	6.5 Box	6.6L D	4800	6084	9200	n/a	---	---	---	67981-2	---	850	800
K2500HD SILV/SIERRA	4x4	Crew Cab	No	6.5 Box	8.1L V8	4800	6084	9200	n/a	---	---	---	67981-2	---	250	250
K2500HD SILV/SIERRA	4x4	Crew Cab	No	8.0 Box	6.0L V8	4800	6084	9200	n/a	---	---	---	67981-2	---	200	200
K2500HD SILV/SIERRA	4x4	Crew Cab	No	8.0 Box	6.6L D	4800	6084	9200	n/a	---	---	---	67981-2	---	950	900
K2500HD SILV/SIERRA	4x4	Crew Cab	No	8.0 Box	8.1L V8	4800	6084	9200	n/a	---	---	---	67981-2	---	300	300
K2500HD SILV/SIERRA	4x4	All	No	Chassis	All	All	All	8501	n/a	---	---	---	67981-2	---	?	?

HB3/HB4 use 27780

- Notes:**
- Ballast amounts are based on a "Representative Vehicle," defined in the vehicle selection guide instructions, and must be modified for all other configurations for axle and GVWR compliance.
 - Recommended snowplow prep package whenever available.
 - Requires bumper notching.

- Recommended Z85 suspension.
- All New Style Only (2nd # in model # is 5 not 0) example: K15903. Refer to label in glove box for model number.
- These Snowplows Are For Personal/Homeowner Use Only.

2006 Chevy/GMC

Section 2 PRO-PLOW®, PRO PLUS® & Heavy Weight Blades

PRO-PLOW®					PRO PLUS®				
7'-6" STEEL	7'-6" POLY	8'-0" STEEL	8'-0" POLY	8'-6" STEEL	7'-6" STEEL	8'-0" STEEL	8'-6" STEEL	9'-0" STEEL	
IUTP75	IUTP75	IUTP80	IUTP80	IUTP85	IUTPP75	IUTPP80	IUTPP85	IUTPP90	
Blade Assembly	60381	62400	60390	62450	60308	64750	66980	66974	66901
AQ&L Assembly Box 1	67950				66490				
AQ&L Assembly Box 2	67951-2								
Hydraulic Kit	64588				64999				
Light Kit	28800								
Choose a Joystick Control or Hand-Held Control	56369								
	56462								

Heavy Weight	
9'-0" STEEL	10'-0" STEEL
IUHW90	IUHW10
62301	62302
62298-1	
62299-1	
64400	
28800	
56369	
56462	

Model	Body Style	DRW	Box Option	Engine Type	Min F G A W R	Min R G A W R	Min G V W R	Harness Kit	UltraMount® system		Ballast Guidelines, lbs (1)								UniMount® system		Ballast Guidelines, lbs (1)				
									Mount Kit	Notes	1	2	3	4	5	6	7	8	9	10	Mount Kit	Notes	1	2	
SUBURBAN/YUKON XL 2500	4x4	SU-4DR	No	---	6.0L V8	4180	5500	8600	67981-2	---	450	700	550	700	---	---	---	---	---	n/a	---	---	---	---	---
K1500 SILV/SIERRA	4x4	Reg Cab	No	6.5 Box	4.3L V6	3925	3750	6400	67960-1	2,3,4,6	450	500	450	500	500	---	---	---	---	n/a	---	---	---	---	---
K1500 SILV/SIERRA	4x4	Reg Cab	No	6.5 Box	4.8L V8	3925	3750	6400	67960-1	2,3,4,6	500	550	550	550	550	---	---	---	---	n/a	---	---	---	---	---
K1500 SILV/SIERRA	4x4	Reg Cab	No	6.5 Box	5.3L V8	3925	3750	6400	67960-1	2,3,4,6	500	550	500	550	500	---	---	---	---	n/a	---	---	---	---	---
K1500 SILV/SIERRA	4x4	Reg Cab	No	6.5 Box	5.3L BIF	3925	3750	6400	67960-1	2,3,4,6	500	550	500	550	500	---	---	---	---	n/a	---	---	---	---	---
K1500 SILV/SIERRA	4x4	Reg Cab	No	8.0 Box	4.3L V6	3925	3750	6400	67960-1	2,3,4,6	450	500	450	500	500	---	---	---	---	n/a	---	---	---	---	---
K1500 SILV/SIERRA	4x4	Reg Cab	No	8.0 Box	4.8L V8	3925	3750	6400	67960-1	2,3,4,6	500	550	500	550	550	---	---	---	---	n/a	---	---	---	---	---
K1500 SILV/SIERRA	4x4	Reg Cab	No	8.0 Box	5.3L V8	3925	3750	6400	67960-1	2,3,4,6	500	550	500	550	500	---	---	---	---	n/a	---	---	---	---	---
K1500 SILV/SIERRA	4x4	Reg Cab	No	8.0 Box	5.3L BIF	3925	3750	6400	67960-1	2,3,4,6	500	550	500	550	550	---	---	---	---	n/a	---	---	---	---	---
K1500 SILV/SIERRA	4x4	Ext Cab	No	6.5 Box	5.3L V8	3925	3750	6700	67960-1	2,3,4,6	550	800	650	---	750	---	---	---	---	n/a	---	---	---	---	---
K1500 SILV/SIERRA	4x4	Ext Cab	No	6.5 Box	5.3L V8	3925	3750	6400	67960-1	2,3,4,6	550	---	---	---	---	---	---	---	---	n/a	---	---	---	---	---
K1500HD SILV/SIERRA	4x4	Crew Cab	No	6.5 Box	6.0L V8	4410	6000	8600	67981-2	---	700	950	800	1000	900	---	---	---	---	n/a	---	---	---	---	---
K2500HD SILV/SIERRA	4x4	Reg Cab	No	8.0 Box	6.0L V8	4800	6084	9200	67981-2	---	400	450	400	450	400	500	550	550	550	n/a	---	---	---	---	---
K2500HD SILV/SIERRA	4x4	Reg Cab	No	8.0 Box	6.0L V8	4500	6084	9200	67981-2	---	400	450	400	450	400	500	550	550	550	n/a	---	---	---	---	---
K2500HD SILV/SIERRA	4x4	Reg Cab	No	8.0 Box	6.6L D	4800	6084	9200	67981-2	---	550	600	600	600	600	900	1000	---	---	n/a	---	---	---	---	---
K2500HD SILV/SIERRA	4x4	Reg Cab	No	8.0 Box	8.1L V8	4800	6084	9200	67981-2	---	450	500	500	500	500	600	600	650	650	n/a	---	---	---	---	---
K2500HD SILV/SIERRA	4x4	Reg Cab	No	8.0 Box	8.1L V8	4500	6084	9200	67981-2	---	700	900	750	950	850	---	---	---	---	n/a	---	---	---	---	---
K2500HD SILV/SIERRA	4x4	Ext Cab	No	6.5 Box	6.0L V8	4800	6084	9200	67981-2	---	400	450	400	450	450	550	550	550	600	n/a	---	---	---	---	---
K2500HD SILV/SIERRA	4x4	Ext Cab	No	6.5 Box	6.0L V8	4670	6084	9200	67981-2	---	400	450	400	450	450	550	550	550	600	n/a	---	---	---	---	---
K2500HD SILV/SIERRA	4x4	Ext Cab	No	6.5 Box	8.1L V8	4800	6084	9200	67981-2	---	500	550	550	550	550	---	---	---	---	n/a	---	---	---	---	---
K2500HD SILV/SIERRA	4x4	Ext Cab	No	6.5 Box	8.1L V8	4670	6084	9200	67981-2	---	850	---	950	---	---	---	---	---	---	n/a	---	---	---	---	---
K2500HD SILV/SIERRA	4x4	Ext Cab	No	8.0 Box	6.0L V8	4800	6084	9200	67981-2	---	350	400	350	400	400	500	500	500	500	n/a	---	---	---	---	---
K2500HD SILV/SIERRA	4x4	Ext Cab	No	8.0 Box	6.0L V8	4670	6084	9200	67981-2	---	350	400	350	400	400	500	500	500	500	n/a	---	---	---	---	---
K2500HD SILV/SIERRA	4x4	Ext Cab	No	8.0 Box	8.1L V8	4800	6084	9200	67981-2	---	450	650	550	700	650	---	---	---	---	n/a	---	---	---	---	---
K2500HD SILV/SIERRA	4x4	Ext Cab	No	8.0 Box	8.1L V8	4670	6084	9200	67981-2	---	950	---	---	---	---	---	---	---	---	n/a	---	---	---	---	---
K2500HD SILV/SIERRA	4x4	Crew Cab	No	6.5 Box	6.0L V8	4800	6084	9200	67981-2	---	300	350	300	350	350	450	450	450	450	n/a	---	---	---	---	---
K2500HD SILV/SIERRA	4x4	Crew Cab	No	6.5 Box	8.1L V8	4800	6084	9200	67981-2	---	550	850	700	900	800	---	---	---	---	n/a	---	---	---	---	---
K2500HD SILV/SIERRA	4x4	Crew Cab	No	8.0 Box	6.0L V8	4800	6084	9200	67981-2	---	300	350	300	350	350	400	450	450	450	n/a	---	---	---	---	---
K2500HD SILV/SIERRA	4x4	Crew Cab	No	8.0 Box	8.1L V8	4800	6084	9200	67981-2	---	900	---	1000	---	---	---	---	---	---	n/a	---	---	---	---	---
K2500HD SILV/SIERRA	4x4	All	No	Chassis	All	All	All	8501	67981-2	---	?	?	?	?	?	?	?	?	n/a	---	---	---	---	---	

Notes:

- Ballast amounts are based on a "Representative Vehicle," defined in the vehicle selection guide instructions, and must be modified for all other configurations for axle and GVWR compliance.
- Recommended snowplow prep package whenever available.
- Requires bumper notching.
- Recommended Z85 suspension.
- All New Style Only (2nd # in model # is 5 not 0) example: K15903. Refer to label in glove box for model number.

2006 Chevy/GMC

Section 2 PRO-PLOW®, PRO PLUS® & Heavy Weight Blades

UltraMount								
PRO-PLOW®					PRO PLUS®			
7'-6" STEEL	7'-6" POLY	8'-0" STEEL	8'-0" POLY	8'-6" STEEL	7'-6" STEEL	8'-0" STEEL	8'-6" STEEL	9'-0" STEEL
IUTP75	IUTPY75	IUTP80	IUTPY80	IUTP85	IUTPP75	IUTPP80	IUTPP85	IUTPP90
60381	62400	60390	62450	60308	64750	66980	66974	66901
67950					66490			
64588					64999			
28800					56369			
56369					56462			

UniMount	
Heavy Weight	
9'-0" STEEL	10'-0" STEEL
IUHW90	IUHW10
62301	62302
62298-1	
62299-1	
64400	
28800	
56369	
56462	

Model	Body Style	DRW	Box Option	Engine Type	Min FGAWR	Min RGAWR	Min GVWR	Harness Kit	UltraMount® system		Ballast Guidelines, lbs (1)								UniMount® system		Ballast Guidelines, lbs (1)		
									Mount Kit	Notes	Mount Kit	Notes	Mount Kit	Notes	Mount Kit	Notes	Mount Kit	Notes					
K3500 SILV/SIERRA	4x4	Reg Cab	No	8.0 Box	6.0L V8	4800	6500	9900	67981-2	---	100	150	100	150	100	200	250	250	250	n/a	---	---	---
K3500 SILV/SIERRA	4x4	Reg Cab	No	8.0 Box	6.6L D	4800	6500	9900	67981-2	---	350	550	450	600	500	1000	---	---	---	n/a	---	---	---
K3500 SILV/SIERRA	4x4	Reg Cab	No	8.0 Box	8.1L V8	4800	6500	9900	67981-2	---	250	300	250	300	300	500	550	650	750	n/a	---	---	---
K3500 SILV/SIERRA	4x4	Reg Cab	Yes	8.0 Box	6.0L V8	4500	8550	11400	67981-2	---	---	---	---	---	150	---	---	350	450	n/a	---	---	---
K3500 SILV/SIERRA	4x4	Ext Cab	No	8.0 Box	6.0L V8	4800	6500	9900	67981-2	---	50	100	50	100	50	150	150	200	200	n/a	---	---	---
K3500 SILV/SIERRA	4x4	Ext Cab	No	8.0 Box	8.1L V8	4800	6500	9900	67981-2	---	550	800	650	850	750	---	---	---	---	n/a	---	---	---
K3500 SILV/SIERRA	4x4	Ext Cab	Yes	8.0 Box	6.0L V8	4800	8550	11400	67981-2	---	---	---	---	---	0	---	---	100	150	n/a	---	---	---
K3500 SILV/SIERRA	4x4	Ext Cab	Yes	8.0 Box	8.1L V8	4800	8550	11400	67981-2	---	---	---	---	---	950	---	---	---	---	n/a	---	---	---
K3500 SILV/SIERRA	4x4	Crew Cab	No	8.0 Box	6.0L V8	4800	6500	9900	67981-2	---	0	0	0	0	0	100	150	250	350	n/a	---	---	---
K3500 SILV/SIERRA	4x4	Crew Cab	No	8.0 Box	8.1L V8	4800	6500	9900	67981-2	---	750	1000	850	1000	950	---	---	---	---	n/a	---	---	---
K3500 SILV/SIERRA	4x4	Crew Cab	Yes	8.0 Box	6.0L V8	4800	8550	11400	67981-2	---	---	---	---	---	0	---	---	500	600	n/a	---	---	---
K3500 SILV/SIERRA	4x4	All	No	Chassis	All	All	All	8501	67981-2	---	?	?	?	?	?	?	?	?	?	n/a	---	---	---
K3500 SILV/SIERRA	4x4	All	Yes	Chassis	All	All	All	8501	67981-2	---	---	---	---	---	?	---	---	?	?	n/a	---	---	---
C4500	4x4	All	Yes	Chassis	All	All	All	10001	2B use 27890 or 1A/2A use 27890	33559	2	---	---	---	---	---	---	?	?	62275	---	?	?
C4500	4x2	All	Yes	Chassis	All	All	All	10001	2B use 27890 or 1A/2A use 27890	64110	2	---	---	---	---	---	---	?	?	62275	---	?	?
C5500	4x4	All	Yes	Chassis	All	All	All	10001	2B use 27890 or 1A/2A use 27890	33559	2	---	---	---	---	---	---	?	?	62275	---	?	?
C5500	4x2	All	Yes	Chassis	All	All	All	10001	2B use 27890 or 1A/2A use 27890	64110	2	---	---	---	---	---	---	?	?	62275	---	?	?

- Notes:**
- Ballast amounts are based on a "Representative Vehicle," defined in the vehicle selection guide instructions, and must be modified for all other configurations for axle and GVWR compliance.
 - Recommended snowplow prep package whenever available.

2006 Chevy/GMC

Section 3 MVP® & MVP PLUS™ Blades

MVP®		MVP PLUS™				
8'-6" STEEL	7'-6" STEEL	7'-6" POLY	8'-6" STEEL	8'-6" POLY	9'-6" STEEL	9'-6" POLY
IUMV85	IUTHVPP75	IUTHVPPY75	IUTHVPP85	IUTHVPPY85	IUTHVPP95	IUTHVPPY95
Blade Assembly	63819	44475	44575	44485	44585	44495
AQ&L Assembly Box 1	63910	44225				
AQ&L Assembly Box 2	67951-2					
Hydraulic Kit	64777					
Light Kit	28800					
Choose a Joystick Control or Hand-Held Control	96369	96700				
	96462	96600				

Model	Body Style	DRW	Box Option	Engine Type	Min F G A W R	Min R G A W R	Min G V W R	Harness Kit	UltraMount® system		67960-1	2,3,4,6	---	550	550	---	---	---	---
									Mount Kit	Notes									
K1500 SILV/SIERRA	4x4	Reg Cab	No	6.5 Box	4.3L V6	3925	3750	6400		67960-1	2,3,4,6	---	550	550	---	---	---	---	---
K1500 SILV/SIERRA	4x4	Reg Cab	No	6.5 Box	4.8L V8	3925	3750	6400		67960-1	2,3,4,6	---	---	650	---	---	---	---	---
K1500 SILV/SIERRA	4x4	Reg Cab	No	6.5 Box	5.3L V8	3925	3750	6400		67960-1	2,3,4,6	---	650	550	---	---	---	---	---
K1500 SILV/SIERRA	4x4	Reg Cab	No	6.5 Box	5.3L BIF	3925	3750	6400		67960-1	2,3,4,6	---	---	600	---	---	---	---	---
K1500 SILV/SIERRA	4x4	Reg Cab	No	8.0 Box	4.3L V6	3925	3750	6400		67960-1	2,3,4,6	---	550	550	---	---	---	---	---
K2500HD SILV/SIERRA	4x4	Reg Cab	No	8.0 Box	6.0L V8	4800	6084	9200		67981-2	---	600	500	450	550	500	650	600	600
K2500HD SILV/SIERRA	4x4	Reg Cab	No	8.0 Box	6.0L V8	4500	6084	9200		67981-2	---	600	500	450	550	500	900	700	700
K2500HD SILV/SIERRA	4x4	Reg Cab	No	8.0 Box	6.6L D	4800	6084	9200		67981-2	---	---	900	800	---	1000	---	---	---
K2500HD SILV/SIERRA	4x4	Reg Cab	No	8.0 Box	8.1L V8	4800	6084	9200		67981-2	---	750	600	550	600	600	---	---	950
K2500HD SILV/SIERRA	4x4	Ext Cab	No	6.5 Box	6.0L V8	4800	6084	9200		67981-2	---	600	500	500	550	550	650	650	650
K2500HD SILV/SIERRA	4x4	Ext Cab	No	6.5 Box	6.0L V8	4670	6084	9200		67981-2	---	600	500	500	550	550	---	---	800
K2500HD SILV/SIERRA	4x4	Ext Cab	No	6.5 Box	8.1L V8	4800	6084	9200		67981-2	---	---	---	900	---	---	---	---	---
K2500HD SILV/SIERRA	4x4	Ext Cab	No	8.0 Box	6.0L V8	4800	6084	9200		67981-2	---	550	450	450	500	500	600	600	550
K2500HD SILV/SIERRA	4x4	Ext Cab	No	8.0 Box	6.0L V8	4670	6084	9200		67981-2	---	600	450	450	500	500	---	---	850
K2500HD SILV/SIERRA	4x4	Crew Cab	No	6.5 Box	6.0L V8	4800	6084	9200		67981-2	---	500	400	400	450	450	800	550	550
K2500HD SILV/SIERRA	4x4	Crew Cab	No	8.0 Box	6.0L V8	4800	6084	9200		67981-2	---	600	400	400	450	450	---	---	850
K2500HD SILV/SIERRA	4x4	All	No	Chassis	All	All	All	8501		67981-2	---	?	?	?	?	?	?	?	?
K3500 SILV/SIERRA	4x4	Reg Cab	No	8.0 Box	6.0L V8	4800	6500	9900		67981-2	---	300	200	150	250	200	350	300	300
K3500 SILV/SIERRA	4x4	Reg Cab	No	8.0 Box	6.6L D	4800	6500	9900		67981-2	---	---	1000	850	---	---	---	---	---
K3500 SILV/SIERRA	4x4	Reg Cab	No	8.0 Box	8.1L V8	4800	6500	9900		67981-2	---	1000	500	350	750	600	---	---	---
K3500 SILV/SIERRA	4x4	Reg Cab	Yes	8.0 Box	6.0L V8	4500	8550	11400		67981-2	---	650	---	---	450	300	---	---	850
K3500 SILV/SIERRA	4x4	Ext Cab	No	8.0 Box	6.0L V8	4800	6500	9900		67981-2	---	250	150	100	200	150	700	450	450
K3500 SILV/SIERRA	4x4	Ext Cab	Yes	8.0 Box	6.0L V8	4800	8550	11400		67981-2	---	450	---	---	200	50	900	650	650
K3500 SILV/SIERRA	4x4	Crew Cab	No	8.0 Box	6.0L V8	4800	6500	9900		67981-2	---	650	100	50	400	250	---	---	900
K3500 SILV/SIERRA	4x4	Crew Cab	Yes	8.0 Box	6.0L V8	4800	8550	11400		67981-2	---	900	---	---	700	500	---	---	---
K3500 SILV/SIERRA	4x4	All	No	Chassis	All	All	All	8501		67981-2	---	?	?	?	?	?	?	?	?
K3500 SILV/SIERRA	4x4	All	Yes	Chassis	All	All	All	8501		67981-2	---	?	?	?	?	?	?	?	?
C4500	4x4	All	Yes	Chassis	All	All	All	10001		33559	2	?	---	---	?	?	?	?	?
C4500	4x2	All	Yes	Chassis	All	All	All	10001		64110	2	?	---	---	?	?	?	?	?
C5500	4x4	All	Yes	Chassis	All	All	All	10001		33559	2	?	---	---	?	?	?	?	?
C5500	4x2	All	Yes	Chassis	All	All	All	10001		64110	2	?	---	---	?	?	?	?	?

- Notes:**
- Ballast amounts are based on a "Representative Vehicle," defined in the vehicle selection guide instructions, and must be modified for all other configurations for axle and GVWR compliance.
 - Recommended snowplow prep package whenever available.

- Requires bumper notching.
- Recommended Z85 suspension.
- All New Style Only (2nd # in model # is 5 not 0) example: K15903. Refer to label in glove box for model number.

2006 Dodge

Section 1 Suburbanite™ & MIDWEIGHT™ Blades

	
Suburbanite™	
6'-8" POLY	7'-4" POLY
SUB68	SUB74
Plow	
Blade Assembly	
27546	27548
AQ&L Assembly Box 1	
27550	
AQ&L Assembly Box 2	
n/a	
Hydraulic Kit	
27516	
Light Kit	
64100	
Choose a Joystick Control	
56369	
or Hand-Held Control	
56462	

	
MIDWEIGHT™	
7'-6" STEEL	7'-6" POLY
IUTH75	IUTHY75
64340	64330
64336	
67992	
64620	
28800	
56369	
56462	

Model	Body Style	DRW	Box Option	Engine Type	Min F G A W R	Min R G A W R	Min G V W R	Harness Kit	Personal Plow system		Ballast Guidelines, lbs (1)	UltraMount® system		Ballast Guidelines, lbs (1)		
									Mount Kit	Notes		Mount Kit	Notes			
DURANGO ST	4x4	SU-4DR	No	---	4.7L FFV	3600	3900	6700	33903	8	---	0	n/a	---	---	---
DURANGO ST	4x4	SU-4DR	No	---	4.7L V8	3600	3900	6700	33903	8	---	0	n/a	---	---	---
DURANGO SLT	4x4	SU-4DR	No	---	4.7L FFV	3600	3900	6700	33903	8	---	0	n/a	---	---	---
DURANGO SLT	4x4	SU-4DR	No	---	4.7L V8	3600	3900	6700	33903	8	---	0	n/a	---	---	---
DURANGO SLT	4x4	SU-4DR	No	---	5.8L V8	3600	3900	6750	33903	8	---	0	n/a	---	---	---
DURANGO LIMITED	4x4	SU-4DR	No	---	4.7L FFV	3600	3900	6700	33903	8	---	0	n/a	---	---	---
DURANGO LIMITED	4x4	SU-4DR	No	---	4.7L V8	3600	3900	6700	33903	8	---	0	n/a	---	---	---
DURANGO LIMITED	4x4	SU-4DR	No	---	5.8L V8	3600	3900	6750	33903	8	---	0	n/a	---	---	---
DAKOTA ST	4x4	Club Cab	No	6.5 Box	3.7L V6	3600	3600	6010	33903	8	---	50	33929	3	300	300
DAKOTA ST	4x4	Club Cab	No	6.5 Box	4.7L V8	3600	3600	6010	33903	8	---	100	33929	3	400	350
DAKOTA ST	4x4	Quad Cab	No	6.5 Box	3.7L V6	3600	3600	6010	33903	8	---	0	33929	3	200	200
DAKOTA ST	4x4	Quad Cab	No	6.5 Box	4.7L V8	3600	3600	6010	33903	8	---	0	33929	3	---	400
DAKOTA SLT	4x4	Club Cab	No	6.5 Box	3.7L V6	3600	3600	6010	33903	8	---	50	33929	3	300	300
DAKOTA SLT	4x4	Club Cab	No	6.5 Box	4.7L V8	3600	3600	6010	33903	8	---	100	33929	3	450	400
DAKOTA SLT	4x4	Club Cab	No	6.5 Box	4.7L V8 HO	3600	3600	6010	33903	8	---	100	33929	3	450	400
DAKOTA SLT	4x4	Quad Cab	No	6.5 Box	3.7L V6	3600	3600	6010	33903	8	---	0	33929	3	250	250
DAKOTA SLT	4x4	Quad Cab	No	6.5 Box	4.7L V8	3600	3600	6010	33903	8	---	0	33929	3	---	---
DAKOTA SLT	4x4	Quad Cab	No	6.5 Box	4.7L V8 HO	3600	3600	6010	33903	8	---	0	33929	3	---	---
DAKOTA LARAMIE	4x4	Club Cab	No	6.5 Box	3.7L V6	3600	3600	6010	33903	8	---	50	33929	3	300	300
DAKOTA LARAMIE	4x4	Club Cab	No	6.5 Box	4.7L V8	3600	3600	6010	33903	8	---	50	33929	3	---	---
DAKOTA LARAMIE	4x4	Club Cab	No	6.5 Box	4.7L V8 HO	3600	3600	6010	33903	8	---	50	33929	3	---	---
DAKOTA LARAMIE	4x4	Quad Cab	No	6.5 Box	3.7L V6	3600	3600	6010	33903	8	---	0	33929	3	250	250
DAKOTA LARAMIE	4x4	Quad Cab	No	6.5 Box	4.7L V8	3600	3600	6010	33903	8	---	0	33929	3	---	---
DAKOTA LARAMIE	4x4	Quad Cab	No	6.5 Box	4.7L V8 HO	3600	3600	6010	33903	8	---	0	33929	3	---	---
RAM 1500 ST	4x4	Reg Cab	No	6.5 Box	4.7L FFV	3900	3900	6350	n/a	---	---	---	30999	3	250	250
RAM 1500 ST	4x4	Reg Cab	No	6.5 Box	4.7L V8	3900	3900	6350	n/a	---	---	---	30999	3	250	250
RAM 1500 ST	4x4	Reg Cab	No	6.5 Box	5.7L V8	3900	3900	6350	n/a	---	---	---	30999	3	300	250
RAM 1500 ST	4x4	Reg Cab	No	8.0 Box	4.7L FFV	3900	3900	6600	n/a	---	---	---	30999	3	---	550
RAM 1500 ST	4x4	Reg Cab	No	8.0 Box	4.7L V8	3900	3900	6600	n/a	---	---	---	30999	3	550	500
RAM 1500 SLT	4x4	Reg Cab	No	6.5 Box	4.7L FFV	3900	3900	6350	n/a	---	---	---	30999	3	200	200
RAM 1500 SLT	4x4	Reg Cab	No	6.5 Box	4.7L V8	3900	3900	6350	n/a	---	---	---	30999	3	200	200
RAM 1500 SLT	4x4	Reg Cab	No	6.5 Box	5.7L V8	3900	3900	6350	n/a	---	---	---	30999	3	250	250
RAM 1500 SLT	4x4	Reg Cab	No	8.0 Box	4.7L FFV	3900	3900	6600	n/a	---	---	---	30999	3	500	450
RAM 1500 SLT	4x4	Reg Cab	No	8.0 Box	4.7L V8	3900	3900	6600	n/a	---	---	---	30999	3	450	400
RAM 1500 SLT	4x4	Mega Cab	No	6.5 Box	5.7L V8	5200	6010	8510	n/a	---	---	---	63883-2	2,3	100	50

H13 use
28400

- Notes:**
- Ballast amounts are based on a "Representative Vehicle," defined in the vehicle selection guide instructions, and must be modified for all other configurations for axle and GVWR compliance.
 - Recommended snowplow prep package whenever available.

- Requires bumper notching.
- These Snowplows Are For Personal/Homeowner Use Only.

2006 Dodge

Section 1 Suburbanite™ & MIDWEIGHT™ Blades

 Suburbanite™	
6'-8" POLY	7'-4" POLY
SUB68	SUB74
Plow Blade Assembly	27546 27548
AQ&L Assembly Box 1	27550
AQ&L Assembly Box 2	n/a
Hydraulic Kit	27516
Light Kit	64100
Choose a Joystick Control	56369
or Hand-Held Control	56462

 UltraMount™	
MIDWEIGHT™	
7'-6" STEEL	7'-6" POLY
IUTH75	IUTHY75
64340	64330
64336	
67992	
64620	
28800	
56369	
56462	

Model	Body Style	DRW	Box Option	Engine Type	Min F G A W R	Min R G A W R	Min G V W R	Harness Kit	Personal Plow system		Ballast Guidelines, lbs (1)	UltraMount® system		Ballast Guidelines, lbs (1)		
									Mount Kit	Notes		Mount Kit	Notes			
RAM 1500 SLT+20" tires	4x4	Reg Cab	No	6.5 Box	4.7L FFV	3900	3900	6350	n/a	---	---	---	30999	3	200	150
RAM 1500 SLT+20" tires	4x4	Reg Cab	No	6.5 Box	4.7L V8	3900	3900	6350	n/a	---	---	---	30999	3	200	200
RAM 1500 SLT+20" tires	4x4	Reg Cab	No	6.5 Box	5.7L V8	3900	3900	6350	n/a	---	---	---	30999	3	250	250
RAM 1500 SLT+LT275/70R17 tires	4x4	Reg Cab	No	6.5 Box	4.7L FFV	3900	3900	6350	n/a	---	---	---	30999	3	250	200
RAM 1500 SLT+LT275/70R17 tires	4x4	Reg Cab	No	6.5 Box	4.7L V8	3900	3900	6350	n/a	---	---	---	30999	3	250	250
RAM 1500 SLT+LT275/70R17 tires	4x4	Reg Cab	No	6.5 Box	5.7L V8	3900	3900	6350	n/a	---	---	---	30999	3	250	250
RAM 1500 LARAMIE	4x4	Mega Cab	No	6.5 Box	5.7L V8	5200	6010	8510	n/a	---	---	---	63883-2	2,3	100	100
RAM 2500	4x4	All	No	Chassis	All	All	All	8501	n/a	---	---	---	63883-2	2,3	?	?
RAM 2500 ST	4x4	Reg Cab	No	8.0 Box	5.7L V8	5200	6000	8650	n/a	---	---	---	63883-2	2,3	200	150
RAM 2500 ST	4x4	Reg Cab	No	8.0 Box	5.9L D HO	5200	6000	9000	n/a	---	---	---	63883-2	2,3	500	450
RAM 2500 ST	4x4	Quad Cab	No	6.5 Box	5.7L V8	5200	6000	8800	n/a	---	---	---	63883-2	2,3	100	50
RAM 2500 ST	4x4	Quad Cab	No	8.0 Box	5.7L V8	5200	6000	8800	n/a	---	---	---	63883-2	2,3	150	150
RAM 2500 ST	4x4	Quad Cab	No	8.0 Box	5.9L D HO	5200	6000	9000	n/a	---	---	---	63883-2	2,3	400	400
RAM 2500 SLT	4x4	Reg Cab	No	8.0 Box	5.7L V8	5200	6010	8650	n/a	---	---	---	63883-2	2,3	200	150
RAM 2500 SLT	4x4	Reg Cab	No	8.0 Box	5.9L D HO	5200	6010	9000	n/a	---	---	---	63883-2	2,3	500	500
RAM 2500 SLT	4x4	Quad Cab	No	6.5 Box	5.7L V8	5200	6010	8800	n/a	---	---	---	63883-2	2,3	50	50
RAM 2500 SLT	4x4	Quad Cab	No	6.5 Box	5.9L D HO	5200	6010	9000	n/a	---	---	---	63883-2	2,3	400	350
RAM 2500 SLT	4x4	Quad Cab	No	8.0 Box	5.7L V8	5200	6010	8800	n/a	---	---	---	63883-2	2,3	150	100
RAM 2500 SLT	4x4	Quad Cab	No	8.0 Box	5.9L D HO	5200	6010	9000	n/a	---	---	---	63883-2	2,3	550	500
RAM 2500 SLT	4x4	Mega Cab	No	6.5 Box	5.7L V8	5200	6010	8800	n/a	---	---	---	63883-2	2,3	100	100
RAM 2500 SLT	4x4	Mega Cab	No	6.5 Box	5.9L D HO	5200	6010	9000	n/a	---	---	---	63883-2	2,3	550	500
RAM 2500 LARAMIE	4x4	Reg Cab	No	8.0 Box	5.7L V8	5200	6010	8650	n/a	---	---	---	63883-2	2,3	200	200
RAM 2500 LARAMIE	4x4	Reg Cab	No	8.0 Box	5.9L D HO	5200	6010	9000	n/a	---	---	---	63883-2	2,3	500	500
RAM 2500 LARAMIE	4x4	Quad Cab	No	6.5 Box	5.7L V8	5200	6010	8800	n/a	---	---	---	63883-2	2,3	50	50
RAM 2500 LARAMIE	4x4	Quad Cab	No	6.5 Box	5.9L D HO	5200	6010	9000	n/a	---	---	---	63883-2	2,3	400	350
RAM 2500 LARAMIE	4x4	Quad Cab	No	8.0 Box	5.7L V8	5200	6010	8800	n/a	---	---	---	63883-2	2,3	150	100
RAM 2500 LARAMIE	4x4	Quad Cab	No	8.0 Box	5.9L D HO	5200	6010	9000	n/a	---	---	---	63883-2	2,3	700	650
RAM 2500 LARAMIE	4x4	Mega Cab	No	6.5 Box	5.7L V8	5200	6010	8800	n/a	---	---	---	63883-2	2,3	100	100
RAM 2500 LARAMIE	4x4	Mega Cab	No	6.5 Box	5.9L D HO	5200	6010	9000	n/a	---	---	---	63883-2	2,3	650	600

H13 use 28400

- Notes:**
- Ballast amounts are based on a "Representative Vehicle," defined in the vehicle selection guide instructions, and must be modified for all other configurations for axle and GVWR compliance.
 - Recommended snowplow prep package whenever available.
 - Requires bumper notching.

2006 Dodge

Section 2

PRO-PLOW®, PRO PLUS® & Heavy Weight Blades

UltraMount																		UniMount	
PRO-PLOW®									PRO PLUS®									Heavy Weight	
7'-6" STEEL	7'-6" POLY	8'-0" STEEL	8'-0" POLY	8'-6" STEEL	7'-6" STEEL	8'-0" STEEL	8'-6" STEEL	9'-0" STEEL	9'-0" STEEL	10'-0" STEEL									
IUTP75	IUTP75	IUTP80	IUTP80	IUTP85	IUTPP75	IUTPP80	IUTPP85	IUTPP90	IUH90	IUHW10									
60381	62400	60390	62450	60308	64750	66980	66974	66901	62301	62302									
67950									66490			62298-1							
67951-2									64999			62299-1							
64588									28800			64400							
28800									56369			28800							
56369									56462			56369							
56462												56462							

Model	Body Style	DRW	Box Option	Engine Type	Min F G A W R	Min R G A W R	Min G V W R	Harness Kit	UltraMount® system		Ballast Guidelines, lbs (1)								UniMount® system		Ballast Guidelines, lbs (1)		
									Mount Kit	Notes									Mount Kit	Notes			
RAM 1500 SLT	4x4	Mega Cab	No	6.5 Box	5.7L V8	5200	6010	8510	63883-2	2,3	200	250	200	250	250	---	---	---	---	n/a	---	---	---
RAM 1500 LARAMIE	4x4	Mega Cab	No	6.5 Box	5.7L V8	5200	6010	8510	63883-2	2,3	200	250	250	250	250	---	---	---	---	n/a	---	---	---
RAM 2500	4x4	All	No	Chassis	All	All	All	8501	63883-2	2,3	?	?	?	?	?	?	?	?	?	n/a	---	---	---
RAM 2500 ST	4x4	Reg Cab	No	8.0 Box	5.7L V8	5200	6000	8650	63883-2	2,3	300	350	300	350	350	450	450	450	500	n/a	---	---	---
RAM 2500 ST	4x4	Reg Cab	No	8.0 Box	5.9L D HO	5200	6000	9000	63883-2	2,3	600	750	600	800	700	---	---	---	---	n/a	---	---	---
RAM 2500 ST	4x4	Quad Cab	No	6.5 Box	5.7L V8	5200	6000	8800	63883-2	2,3	200	250	250	250	350	350	350	400	400	n/a	---	---	---
RAM 2500 ST	4x4	Quad Cab	No	8.0 Box	5.7L V8	5200	6000	8800	63883-2	2,3	250	300	250	300	300	400	400	400	450	n/a	---	---	---
RAM 2500 SLT	4x4	Reg Cab	No	8.0 Box	5.7L V8	5200	6010	8650	63883-2	2,3	300	350	350	350	350	450	450	450	500	n/a	---	---	---
RAM 2500 SLT	4x4	Reg Cab	No	8.0 Box	5.9L D HO	5200	6010	9000	63883-2	2,3	850	---	950	---	---	---	---	---	---	n/a	---	---	---
RAM 2500 SLT	4x4	Quad Cab	No	6.5 Box	5.7L V8	5200	6010	8800	63883-2	2,3	200	250	200	250	250	350	350	350	400	n/a	---	---	---
RAM 2500 SLT	4x4	Quad Cab	No	6.5 Box	5.9L D HO	5200	6010	9000	63883-2	2,3	800	---	900	---	1000	---	---	---	---	n/a	---	---	---
RAM 2500 SLT	4x4	Quad Cab	No	8.0 Box	5.7L V8	5200	6010	8800	63883-2	2,3	250	300	250	300	300	350	400	400	400	n/a	---	---	---
RAM 2500 SLT	4x4	Mega Cab	No	6.5 Box	5.7L V8	5200	6010	8800	63883-2	2,3	200	250	250	250	250	350	350	400	400	n/a	---	---	---
RAM 2500 LARAMIE	4x4	Reg Cab	No	8.0 Box	5.7L V8	5200	6010	8650	63883-2	2,3	300	350	350	350	350	450	450	450	500	n/a	---	---	---
RAM 2500 LARAMIE	4x4	Reg Cab	No	8.0 Box	5.9L D HO	5200	6010	9000	63883-2	2,3	700	950	800	1000	900	---	---	---	---	n/a	---	---	---
RAM 2500 LARAMIE	4x4	Quad Cab	No	6.5 Box	5.7L V8	5200	6010	8800	63883-2	2,3	200	250	200	250	250	350	350	350	400	n/a	---	---	---
RAM 2500 LARAMIE	4x4	Quad Cab	No	6.5 Box	5.9L D HO	5200	6010	9000	63883-2	2,3	950	---	---	---	---	---	---	---	---	n/a	---	---	---
RAM 2500 LARAMIE	4x4	Quad Cab	No	8.0 Box	5.7L V8	5200	6010	8800	63883-2	2,3	250	300	250	300	300	400	400	400	450	n/a	---	---	---
RAM 2500 LARAMIE	4x4	Mega Cab	No	6.5 Box	5.7L V8	5200	6010	8800	63883-2	2,3	250	300	250	300	250	350	400	400	400	n/a	---	---	---
RAM 3500	4x4	All	No	Chassis	All	All	All	8501	63883-2	2,3	?	?	?	?	?	?	?	?	?	n/a	---	---	---
RAM 3500 LARAMIE	4x4	Reg Cab	Yes	8.0 Box	5.7L V8	5200	9350	11500	63883-2	2,3	---	---	---	---	50	---	---	200	200	n/a	---	---	---
RAM 3500 LARAMIE	4x4	Reg Cab	Yes	8.0 Box	5.9L D HO	5200	9350	12200	63883-2	2,3	---	---	---	---	550	---	---	---	---	n/a	---	---	---
RAM 3500 LARAMIE	4x4	Quad Cab	No	6.5 Box	5.9L D HO	5200	6200	9900	63883-2	2,3	950	---	---	---	---	---	---	---	---	n/a	---	---	---
RAM 3500 ST	4x4	Reg Cab	Yes	8.0 Box	5.7L V8	5200	9350	11500	63883-2	2,3	---	---	---	---	50	---	---	200	200	n/a	---	---	---
RAM 3500 ST	4x4	Reg Cab	Yes	8.0 Box	5.9L D HO	5200	9350	12200	63883-2	2,3	---	---	---	---	350	---	---	1000	---	n/a	---	---	---
RAM 3500 ST	4x4	Quad Cab	No	6.5 Box	5.9L D HO	5200	6200	9900	63883-2	2,3	600	850	750	900	800	---	---	---	---	n/a	---	---	---
RAM 3500 ST	4x4	Quad Cab	Yes	8.0 Box	5.7L V8	5200	9350	11500	63883-2	2,3	---	---	---	---	0	---	---	100	100	n/a	---	---	---
RAM 3500 SLT	4x4	Reg Cab	Yes	8.0 Box	5.7L V8	5200	9350	11500	63883-2	2,3	---	---	---	---	50	---	---	200	200	n/a	---	---	---
RAM 3500 SLT	4x4	Reg Cab	Yes	8.0 Box	5.9L D HO	5200	9350	12200	63883-2	2,3	---	---	---	---	400	---	---	---	---	n/a	---	---	---
RAM 3500 SLT	4x4	Quad Cab	No	6.5 Box	5.9L D HO	5200	6200	9900	63883-2	2,3	800	---	900	---	1000	---	---	---	---	n/a	---	---	---
RAM 3500 SLT	4x4	Quad Cab	Yes	8.0 Box	5.7L V8	5200	9350	11500	63883-2	2,3	---	---	---	---	0	---	---	100	100	n/a	---	---	---

- Notes:**
1. Ballast amounts are based on a "Representative Vehicle," defined in the vehicle selection guide instructions, and must be modified for all other configurations for axle and GVWR compliance.
 2. Recommended snowplow prep package whenever available.
 3. Requires bumper notching.

2006 Dodge

Section 3 MVP® & MVP PLUS™ Blades

MVP®	MVP PLUS™					
8'-6" STEEL	7'-6" STEEL	7'-6" POLY	8'-6" STEEL	8'-6" POLY	9'-6" STEEL	9'-6" POLY
IUMVP85	IUTHMVP75	IUTHMVPY75	IUTHMVP85	IUTHMVPY85	IUTHMVP95	IUTHMVPY95
Blade Assembly 63819	44475	44575	44485	44585	44495	44595
AQ&L Assembly Box 1 63910	44225					
AQ&L Assembly Box 2 67951-2						
Hydraulic Kit 64777						
Light Kit 28800						
Choose a Joystick Control 96369	96700					
or Hand-Held Control 96462	96600					

Model	4x4	Body Style	DRW	Box Option	Engine Type	Min F G A W R	Min R G A W R	Min G V W R	Harness Kit	UltraMount® system		300	300	---	---	---	---	
										Mount Kit	Notes							
RAM 1500 SLT	4x4	Mega Cab	No	6.5 Box	5.7L V8	5200	6010	8510	H13 use 28400	63883-2	2,3	---	300	300	---	---	---	---
RAM 1500 LARAMIE	4x4	Mega Cab	No	6.5 Box	5.7L V8	5200	6010	8510		63883-2	2,3	---	350	300	---	---	---	---
RAM 2500	4x4	All	No	Chassis	All	All	All	8501		63883-2	2,3	?	?	?	?	?	?	?
RAM 2500 ST	4x4	Reg Cab	No	8.0 Box	5.7L V8	5200	6000	8650		63883-2	2,3	500	400	400	450	450	600	550
RAM 2500 ST	4x4	Quad Cab	No	6.5 Box	5.7L V8	5200	6000	8800		63883-2	2,3	450	300	300	350	350	500	450
RAM 2500 ST	4x4	Quad Cab	No	8.0 Box	5.7L V8	5200	6000	8800		63883-2	2,3	450	350	350	400	400	500	500
RAM 2500 SLT	4x4	Reg Cab	No	8.0 Box	5.7L V8	5200	6010	8650		63883-2	2,3	500	400	400	450	450	600	550
RAM 2500 SLT	4x4	Quad Cab	No	6.5 Box	5.7L V8	5200	6010	8800		63883-2	2,3	400	300	300	350	350	450	450
RAM 2500 SLT	4x4	Quad Cab	No	8.0 Box	5.7L V8	5200	6010	8800		63883-2	2,3	450	350	350	400	400	500	500
RAM 2500 SLT	4x4	Mega Cab	No	6.5 Box	5.7L V8	5200	6010	8800		63883-2	2,3	450	350	300	400	350	---	650
RAM 2500 LARAMIE	4x4	Reg Cab	No	8.0 Box	5.7L V8	5200	6010	8650		63883-2	2,3	550	400	400	450	450	600	550
RAM 2500 LARAMIE	4x4	Quad Cab	No	6.5 Box	5.7L V8	5200	6010	8800		63883-2	2,3	400	300	300	350	350	500	450
RAM 2500 LARAMIE	4x4	Quad Cab	No	8.0 Box	5.7L V8	5200	6010	8800		63883-2	2,3	450	350	350	400	400	500	500
RAM 2500 LARAMIE	4x4	Mega Cab	No	6.5 Box	5.7L V8	5200	6010	8800		63883-2	2,3	450	350	300	400	350	---	750
RAM 3500	4x4	All	No	Chassis	All	All	All	8501		63883-2	2,3	?	?	?	?	?	?	?
RAM 3500 LARAMIE	4x4	Reg Cab	Yes	8.0 Box	5.7L V8	5200	9350	11500		63883-2	2,3	250	---	---	200	150	300	250
RAM 3500 ST	4x4	Reg Cab	Yes	8.0 Box	5.7L V8	5200	9350	11500		63883-2	2,3	250	---	---	200	150	300	250
RAM 3500 ST	4x4	Reg Cab	Yes	8.0 Box	5.9L D HO	5200	9350	12200		63883-2	2,3	---	---	---	---	950	---	---
RAM 3500 ST	4x4	Quad Cab	Yes	8.0 Box	5.7L V8	5200	9350	11500		63883-2	2,3	150	---	---	100	50	200	150
RAM 3500 SLT	4x4	Reg Cab	Yes	8.0 Box	5.7L V8	5200	9350	11500		63883-2	2,3	250	---	---	200	150	300	250
RAM 3500 SLT	4x4	Quad Cab	Yes	8.0 Box	5.7L V8	5200	9350	11500		63883-2	2,3	150	---	---	100	50	200	150

- Notes:**
- Ballast amounts are based on a "Representative Vehicle," defined in the vehicle selection guide instructions, and must be modified for all other configurations for axle and GVWR compliance.
 - Recommended snowplow prep package whenever available.
 - Requires bumper notching.

2006 Ford

Section 1 Suburbanite™ & MIDWEIGHT™ Blades

	
Suburbanite™	
6'-8" POLY	7'-4" POLY
SUB68	SUB74
Plow	
Blade Assembly	
27546	27548
AQ&L Assembly Box 1	
27550	
AQ&L Assembly Box 2	
n/a	
Hydraulic Kit	
27516	
Light Kit	
64100	
Choose a Joystick Control	
56369	
or Hand-Held Control	
56462	

	
MIDWEIGHT™	
7'-6" STEEL	7'-6" POLY
IUTH75	IUTHY75
64340	64330
64336	
67992	
64620	
28800	
56369	
56462	

Model	4x4	Body Style	DRW	Box Option	Engine Type	Min F G A W R	Min R G A W R	Min G V W R	Harness Kit	Personal Plow system		Ballast Guidelines, lbs (1)	UltraMount® system		Ballast Guidelines, lbs (1)		
										Mount Kit	Notes		Mount Kit	Notes			
EXPLORER SPORT TRAC	4x4	---	No	4.0 Box	4.0L V6	2900	3200	5840	HB5 use 8436	1203	8	300	450	n/a	---	---	---
RANGER	4x4	Reg Cab	No	6.0 Box	3.0L V6	2710	2750	4760		1203	8	100	100	n/a	---	---	---
RANGER	4x4	Reg Cab	No	7.0 Box	4.0L V6	2710	2750	5040		1203	8	100	100	n/a	---	---	---
RANGER	4x4	Reg Cab	No	7.0 Box	4.0L V6	2710	2750	4840		1203	8	100	100	n/a	---	---	---
RANGER	4x4	Super Cab	No	6.0 Box	4.0L V6	2850	2600	5300		1203	8	100	150	n/a	---	---	---
RANGER	4x4	Super Cab	No	6.0 Box	4.0L V6	2850	2600	5160		1203	8	100	100	n/a	---	---	---
RANGER	4x4	Super Cab	No	6.0 Box	4.0L V6	2850	2600	5140		1203	8	100	150	n/a	---	---	---
RANGER	4x4	Super Cab	No	6.0 Box	4.0L V6	2850	2600	5000		1203	8	100	150	n/a	---	---	---
F150	4x4	Reg Cab	No	6.5 Box	4.6L V8	3600	3500	6800		1233	8	---	0	64500	3	950	900
F150	4x4	Reg Cab	No	6.5 Box	5.4L V8	3600	3500	6850		1233	8	---	0	64500	3	---	---
F150	4x4	Reg Cab	No	8.0 Box	4.6L V8	3750	3800	6950	1233	8	---	50	64500	3	1000	950	
F150	4x4	Reg Cab	No	8.0 Box	5.4L V8	4300	4800	8200	1233	8	---	0	64500	3	250	250	
F150	4x4	Reg Cab	No	8.0 Box	5.4L V8	4050	4800	8200	1233	8	---	0	64500	3	500	450	
F150	4x4	Reg Cab	No	8.0 Box	5.4L V8	3750	3850	6950	1233	8	---	50	64500	3	---	---	
F150	4x4	Super Cab	No	5.5 Box	4.6L V8	3750	3800	6900	1233	8	---	0	64500	3	---	800	
F150	4x4	Super Cab	No	5.5 Box	5.4L V8	3750	3850	7150	1233	8	---	0	64500	3	---	---	
F150	4x4	Super Cab	No	6.5 Box	4.6L V8	3900	3800	6950	1233	8	---	0	64500	3	750	700	
F150	4x4	Super Cab	No	6.5 Box	5.4L V8	3900	3850	7200	1233	8	---	0	64500	3	---	---	
F150	4x4	Super Cab	No	8.0 Box	5.4L V8	4300	4800	8200	1233	8	---	0	64500	3	200	200	
F150	4x4	Super Cab	No	8.0 Box	5.4L V8	4050	4800	8200	1233	8	---	0	64500	3	---	---	
F150	4x4	SuperCrew	No	5.5 Box	4.6L V8	3750	3800	6900	1233	8	---	0	64500	3	---	---	
F150	4x4	SuperCrew	No	5.5 Box	5.4L V8	3900	3850	7200	1233	8	---	0	64500	3	---	---	
F150	4x4	SuperCrew	No	6.5 Box	4.6L V8	3750	3800	6900	1233	8	---	0	64500	3	---	---	
F150	4x4	SuperCrew	No	6.5 Box	5.4L V8	3900	3850	7200	1233	8	---	0	64500	3	---	---	
F250 SUPER DUTY	4x4	Reg Cab	No	8.0 Box	5.4L V8	5600	6100	9000	H13 use 28400 or 2B use 8439	n/a	---	---	---	33259	2,10	200	200
F250 SUPER DUTY	4x4	Reg Cab	No	8.0 Box	5.4L V8	5200	6100	9000		n/a	---	---	---	33259	2,10	200	200
F250 SUPER DUTY	4x4	Reg Cab	No	8.0 Box	5.4L V8	4800	6100	9000		n/a	---	---	---	33259	2,10	250	250
F250 SUPER DUTY	4x4	Reg Cab	No	8.0 Box	5.4L V8	4400	6100	9000		n/a	---	---	---	33259	2,10	550	550
F250 SUPER DUTY	4x4	Reg Cab	No	8.0 Box	6.0L D	6000	6100	9600		n/a	---	---	---	33259	2,10	450	400
F250 SUPER DUTY	4x4	Reg Cab	No	8.0 Box	6.0L D	5600	6100	9600		n/a	---	---	---	33259	2,10	450	450
F250 SUPER DUTY	4x4	Reg Cab	No	8.0 Box	6.0L D	5200	6100	9600		n/a	---	---	---	33259	2,10	450	450
F250 SUPER DUTY	4x4	Reg Cab	No	8.0 Box	6.8L V10	5600	6100	9200		n/a	---	---	---	33259	2,10	300	250
F250 SUPER DUTY	4x4	Reg Cab	No	8.0 Box	6.8L V10	5200	6100	9200		n/a	---	---	---	33259	2,10	300	250
F250 SUPER DUTY	4x4	Reg Cab	No	8.0 Box	6.8L V10	4800	6100	9200		n/a	---	---	---	33259	2,10	300	300
F250 SUPER DUTY	4x4	Reg Cab	No	8.0 Box	6.8L V10	4400	6100	9200		n/a	---	---	---	33259	2,10	1000	950

- Notes:**
- Ballast amounts are based on a "Representative Vehicle," defined in the vehicle selection guide instructions, and must be modified for all other configurations for axle and GVWR compliance.
 - Recommended snowplow prep package whenever available.

- Requires bumper notching.
- These Snowplows Are For Personal/Homeowner Use Only.
- May require bumper or air dam notching.

2006 Ford

Section 1 Suburbanite™ & MIDWEIGHT™ Blades

 Suburbanite™	
6'-8" POLY SUB68	7'-4" POLY SUB74
Plow Blade Assembly AQ&L Assembly Box 1 AQ&L Assembly Box 2 Hydraulic Kit Light Kit Choose a Joystick Control or Hand-Held Control	
27546	27548
27550	
n/a	
27516	
64100	
56369	
56462	

 UltraMount™	
MIDWEIGHT™	
7'-6" STEEL IUTH75	7'-6" POLY IUTHY75
64340	64330
64336	
67992	
64620	
28800	
56369	
56462	

Model	Body Style	DRW	Box Option	Engine Type	Min F G A W R	Min R G A W R	Min G V W R	Harness Kit	Personal Plow system		Ballast Guidelines, lbs (1)	UltraMount® system		Ballast Guidelines, lbs (1)	
									Mount Kit	Notes		Mount Kit	Notes		
F250 SUPER DUTY	4x4	Super Cab	No	6.8 Box	5.4L V8	5600	6100	9200	n/a	---	---	33259	2,10	150	150
F250 SUPER DUTY	4x4	Super Cab	No	6.8 Box	5.4L V8	5200	6100	9200	n/a	---	---	33259	2,10	150	150
F250 SUPER DUTY	4x4	Super Cab	No	6.8 Box	5.4L V8	4800	6100	9200	n/a	---	---	33259	2,10	150	150
F250 SUPER DUTY	4x4	Super Cab	No	6.8 Box	5.4L V8	4400	6100	9200	n/a	---	---	33259	2,10	900	850
F250 SUPER DUTY	4x4	Super Cab	No	6.8 Box	6.0L D	6000	6100	9800	n/a	---	---	33259	2,10	400	350
F250 SUPER DUTY	4x4	Super Cab	No	6.8 Box	6.0L D	5600	6100	9800	n/a	---	---	33259	2,10	400	400
F250 SUPER DUTY	4x4	Super Cab	No	6.8 Box	6.0L D	5200	6100	9800	n/a	---	---	33259	2,10	400	400
F250 SUPER DUTY	4x4	Super Cab	No	6.8 Box	6.8L V10	5600	6100	9400	n/a	---	---	33259	2,10	200	200
F250 SUPER DUTY	4x4	Super Cab	No	6.8 Box	6.8L V10	5200	6100	9400	n/a	---	---	33259	2,10	250	200
F250 SUPER DUTY	4x4	Super Cab	No	6.8 Box	6.8L V10	4800	6100	9400	n/a	---	---	33259	2,10	250	200
F250 SUPER DUTY	4x4	Super Cab	No	8.0 Box	5.4L V8	5600	6100	9400	n/a	---	---	33259	2,10	200	200
F250 SUPER DUTY	4x4	Super Cab	No	8.0 Box	5.4L V8	5200	6100	9400	n/a	---	---	33259	2,10	200	200
F250 SUPER DUTY	4x4	Super Cab	No	8.0 Box	5.4L V8	4800	6100	9400	n/a	---	---	33259	2,10	200	200
F250 SUPER DUTY	4x4	Super Cab	No	8.0 Box	6.0L D	6000	6100	10000	n/a	---	---	33259	2,10	400	400
F250 SUPER DUTY	4x4	Super Cab	No	8.0 Box	6.0L D	5600	6100	10000	n/a	---	---	33259	2,10	450	400
F250 SUPER DUTY	4x4	Super Cab	No	8.0 Box	6.0L D	5200	6100	10000	n/a	---	---	33259	2,10	600	550
F250 SUPER DUTY	4x4	Super Cab	No	8.0 Box	6.8L V10	5600	6100	9600	n/a	---	---	33259	2,10	250	250
F250 SUPER DUTY	4x4	Super Cab	No	8.0 Box	6.8L V10	5200	6100	9600	n/a	---	---	33259	2,10	250	250
F250 SUPER DUTY	4x4	Super Cab	No	8.0 Box	6.8L V10	4800	6100	9600	n/a	---	---	33259	2,10	250	250
F250 SUPER DUTY	4x4	Crew Cab	No	6.8 Box	5.4L V8	5600	6100	9400	n/a	---	---	33259	2,10	150	150
F250 SUPER DUTY	4x4	Crew Cab	No	6.8 Box	5.4L V8	5200	6100	9400	n/a	---	---	33259	2,10	150	150
F250 SUPER DUTY	4x4	Crew Cab	No	6.8 Box	6.0L D	6000	6100	10000	n/a	---	---	33259	2,10	350	350
F250 SUPER DUTY	4x4	Crew Cab	No	6.8 Box	6.0L D	5600	6100	10000	n/a	---	---	33259	2,10	400	400
F250 SUPER DUTY	4x4	Crew Cab	No	6.8 Box	6.0L D	5200	6100	10000	n/a	---	---	33259	2,10	600	550
F250 SUPER DUTY	4x4	Crew Cab	No	6.8 Box	6.8L V10	5600	6100	9600	n/a	---	---	33259	2,10	200	200
F250 SUPER DUTY	4x4	Crew Cab	No	6.8 Box	6.8L V10	5200	6100	9600	n/a	---	---	33259	2,10	200	200
F250 SUPER DUTY	4x4	Crew Cab	No	6.8 Box	6.8L V10	4800	6100	9600	n/a	---	---	33259	2,10	250	200
F250 SUPER DUTY	4x4	Crew Cab	No	8.0 Box	5.4L V8	5600	6100	9600	n/a	---	---	33259	2,10	200	200
F250 SUPER DUTY	4x4	Crew Cab	No	8.0 Box	5.4L V8	5200	6100	9600	n/a	---	---	33259	2,10	200	200
F250 SUPER DUTY	4x4	Crew Cab	No	8.0 Box	5.4L V8	4800	6100	9600	n/a	---	---	33259	2,10	200	200
F250 SUPER DUTY	4x4	Crew Cab	No	8.0 Box	6.0L D	6000	6100	10000	n/a	---	---	33259	2,10	400	400
F250 SUPER DUTY	4x4	Crew Cab	No	8.0 Box	6.0L D	5600	6100	10000	n/a	---	---	33259	2,10	400	400
F250 SUPER DUTY	4x4	Crew Cab	No	8.0 Box	6.8L V10	5600	6100	9800	n/a	---	---	33259	2,10	250	250
F250 SUPER DUTY	4x4	Crew Cab	No	8.0 Box	6.8L V10	5200	6100	9800	n/a	---	---	33259	2,10	250	250
F250 SUPER DUTY	4x4	Crew Cab	No	8.0 Box	6.8L V10	4800	6100	9800	n/a	---	---	33259	2,10	700	650

H13 use 28400 or 2B use 8439

- Notes:**
- Ballast amounts are based on a "Representative Vehicle," defined in the vehicle selection guide instructions, and must be modified for all other configurations for axle and GVWR compliance.
 - Recommended snowplow prep package whenever available.
 - May require bumper or air dam notching.

2006 Ford

Section 2 PRO-PLOW®, PRO PLUS® & Heavy Weight Blades

PRO-PLOW®					PRO PLUS®				
7'-6" STEEL	7'-6" POLY	8'-0" STEEL	8'-0" POLY	8'-6" STEEL	7'-6" STEEL	8'-0" STEEL	8'-6" STEEL	9'-0" STEEL	
IUTP75	IUTPY75	IUTP80	IUTPY80	IUTP85	IUTPP75	IUTPP80	IUTPP85	IUTPP90	
60381	62400	60390	62450	60308	64750	66980	66974	66901	
67950					66490				
64588					64999				
28800					56369				
56462									

Heavy Weight	
9'-0" STEEL	10'-0" STEEL
IUHW90	IUHW10
62301	62302
62298-1	
62299-1	
64400	
28800	
56369	
56462	

Model	Body Style	DRW	Box Option	Engine Type	Min FAWR	Min RGAWR	Min GVWR	Harness Kit	UltraMount® system		Ballast Guidelines, lbs (1)								UniMount® system		Ballast Guidelines, lbs (1)				
									Mount Kit	Notes	Mount Kit	Notes	Mount Kit	Notes	Mount Kit	Notes									
F150	4x4	Reg Cab	No	8.0 Box	5.4L V8	4300	4800	8200	H13 use 28400	64500	3	350	500	400	550	450	---	---	---	---	n/a	---	---	---	
F250 SUPER DUTY	4x4	Reg Cab	No	8.0 Box	5.4L V8	5600	6100	9000	H13 use 28400 or 2B use 8439	33259	2,10	350	400	350	400	350	450	500	500	500	n/a	---	---	---	
F250 SUPER DUTY	4x4	Reg Cab	No	8.0 Box	5.4L V8	5200	6100	9000		33259	2,10	350	400	350	400	350	450	500	500	500	500	n/a	---	---	---
F250 SUPER DUTY	4x4	Reg Cab	No	8.0 Box	5.4L V8	4800	6100	9000		33259	2,10	350	400	400	400	400	500	600	650	750	750	n/a	---	---	---
F250 SUPER DUTY	4x4	Reg Cab	No	8.0 Box	6.0L D	6000	6100	9600		33259	2,10	550	600	550	600	600	700	700	700	700	700	n/a	---	---	---
F250 SUPER DUTY	4x4	Reg Cab	No	8.0 Box	6.0L D	5600	6100	9600		33259	2,10	600	600	600	600	600	700	700	750	750	750	n/a	---	---	---
F250 SUPER DUTY	4x4	Reg Cab	No	8.0 Box	6.0L D	5200	6100	9600		33259	2,10	600	800	650	850	750	---	---	---	---	---	n/a	---	---	---
F250 SUPER DUTY	4x4	Reg Cab	No	8.0 Box	6.8L V10	5600	6100	9200		33259	2,10	400	450	400	450	450	500	550	550	550	550	n/a	---	---	---
F250 SUPER DUTY	4x4	Reg Cab	No	8.0 Box	6.8L V10	4800	6100	9200		33259	2,10	400	500	450	550	450	900	1000	---	---	---	n/a	---	---	---
F250 SUPER DUTY	4x4	Super Cab	No	6.8 Box	5.4L V8	5600	6100	9200		33259	2,10	250	300	300	300	300	400	400	400	450	450	n/a	---	---	---
F250 SUPER DUTY	4x4	Super Cab	No	6.8 Box	5.4L V8	5200	6100	9200		33259	2,10	300	350	300	350	300	400	450	450	450	450	n/a	---	---	---
F250 SUPER DUTY	4x4	Super Cab	No	6.8 Box	5.4L V8	4800	6100	9200		33259	2,10	300	400	300	400	350	800	900	1000	---	---	n/a	---	---	---
F250 SUPER DUTY	4x4	Super Cab	No	6.8 Box	6.0L D	6000	6100	9800		33259	2,10	500	550	500	550	550	600	650	650	650	650	n/a	---	---	---
F250 SUPER DUTY	4x4	Super Cab	No	6.8 Box	6.0L D	5600	6100	9800		33259	2,10	500	550	550	550	550	650	650	700	700	700	n/a	---	---	---
F250 SUPER DUTY	4x4	Super Cab	No	6.8 Box	6.0L D	5200	6100	9800		33259	2,10	900	---	1000	---	---	---	---	---	---	---	n/a	---	---	---
F250 SUPER DUTY	4x4	Super Cab	No	6.8 Box	6.8L V10	5600	6100	9400		33259	2,10	350	350	350	400	350	450	450	500	500	500	n/a	---	---	---
F250 SUPER DUTY	4x4	Super Cab	No	6.8 Box	6.8L V10	5200	6100	9400		33259	2,10	350	400	350	400	400	450	500	500	500	500	n/a	---	---	---
F250 SUPER DUTY	4x4	Super Cab	No	6.8 Box	6.8L V10	4800	6100	9400		33259	2,10	550	800	650	850	750	---	---	---	---	---	n/a	---	---	---
F250 SUPER DUTY	4x4	Super Cab	No	8.0 Box	5.4L V8	5600	6100	9400		33259	2,10	300	350	300	350	350	400	450	450	450	450	n/a	---	---	---
F250 SUPER DUTY	4x4	Super Cab	No	8.0 Box	5.4L V8	5200	6100	9400		33259	2,10	350	350	350	350	350	450	450	500	500	500	n/a	---	---	---
F250 SUPER DUTY	4x4	Super Cab	No	8.0 Box	5.4L V8	4800	6100	9400		33259	2,10	550	800	650	850	750	---	---	---	---	---	n/a	---	---	---
F250 SUPER DUTY	4x4	Super Cab	No	8.0 Box	6.0L D	6000	6100	10000		33259	2,10	550	550	550	550	550	650	650	650	700	700	n/a	---	---	---
F250 SUPER DUTY	4x4	Super Cab	No	8.0 Box	6.0L D	5600	6100	10000		33259	2,10	550	600	550	600	600	650	700	700	750	750	n/a	---	---	---
F250 SUPER DUTY	4x4	Super Cab	No	8.0 Box	6.8L V10	5600	6100	9600		33259	2,10	350	400	400	400	400	500	500	500	500	500	n/a	---	---	---
F250 SUPER DUTY	4x4	Super Cab	No	8.0 Box	6.8L V10	5200	6100	9600		33259	2,10	400	400	400	450	400	500	500	550	550	550	n/a	---	---	---
F250 SUPER DUTY	4x4	Crew Cab	No	6.8 Box	5.4L V8	5600	6100	9400		33259	2,10	250	300	300	300	300	400	400	400	400	400	n/a	---	---	---
F250 SUPER DUTY	4x4	Crew Cab	No	6.8 Box	5.4L V8	5200	6100	9400		33259	2,10	300	300	300	350	300	400	400	450	450	450	n/a	---	---	---
F250 SUPER DUTY	4x4	Crew Cab	No	6.8 Box	5.4L V8	4800	6100	9400		33259	2,10	600	800	700	850	750	---	---	---	---	---	n/a	---	---	---
F250 SUPER DUTY	4x4	Crew Cab	No	6.8 Box	6.0L D	6000	6100	10000		33259	2,10	500	550	500	550	500	600	600	650	650	650	n/a	---	---	---
F250 SUPER DUTY	4x4	Crew Cab	No	6.8 Box	6.0L D	5600	6100	10000		33259	2,10	500	550	550	550	550	650	650	650	700	700	n/a	---	---	---
F250 SUPER DUTY	4x4	Crew Cab	No	6.8 Box	6.8L V10	5600	6100	9600		33259	2,10	300	350	350	350	350	450	450	450	500	500	n/a	---	---	---
F250 SUPER DUTY	4x4	Crew Cab	No	6.8 Box	6.8L V10	5200	6100	9600		33259	2,10	350	350	350	400	350	450	450	500	500	500	n/a	---	---	---

- Notes:
- Ballast amounts are based on a "Representative Vehicle," defined in the vehicle selection guide instructions, and must be modified for all other configurations for axle and GVWR compliance.
 - Recommended snowplow prep package whenever available.

- Requires bumper notching.
- May require bumper or air dam notching.

2006 Ford

Section 2 PRO-PLOW®, PRO PLUS® & Heavy Weight Blades

UltraMount®								
PRO-PLOW®					PRO PLUS®			
7'-6" STEEL	7'-6" POLY	8'-0" STEEL	8'-0" POLY	8'-6" STEEL	7'-6" STEEL	8'-0" STEEL	8'-6" STEEL	9'-0" STEEL
IUTP75	IUTP75	IUTP80	IUTP80	IUTP85	IUTPP75	IUTPP80	IUTPP85	IUTPP90
60381	62400	60390	62450	60308	64750	66980	66974	66901
Blade Assembly AQ&L Assembly Box 1 AQ&L Assembly Box 2				67950	66490			
Hydraulic Kit					64588			
Light Kit					28800			
Choose a Joystick Control or Hand-Held Control					56369			
					56462			

UniMount®	
Heavy Weight	
9'-0" STEEL	10'-0" STEEL
IUHW90	IUHW10
62301	62302
62298-1	
62299-1	
64400	
28800	
56369	
56462	

Model	Body Style	DRW	Box Option	Engine Type	Min F G A W R	Min R G A W R	Min G V W R	Harness Kit	UltraMount® system		Ballast Guidelines, lbs (1)									UniMount® system		Ballast Guidelines, lbs (1)		
									Mount Kit	Notes													Mount Kit	Notes
F250 SUPER DUTY	4x4	Crew Cab	No	8.0 Box	5.4L V8	5600	6100	9600		33259	2,10	300	350	300	350	350	400	450	450	450	n/a	---	---	---
F250 SUPER DUTY	4x4	Crew Cab	No	8.0 Box	5.4L V8	5200	6100	9600		33259	2,10	300	350	350	350	450	450	450	500	n/a	---	---	---	
F250 SUPER DUTY	4x4	Crew Cab	No	8.0 Box	6.0L D	6000	6100	10000		33259	2,10	500	550	550	550	650	650	650	700	n/a	---	---	---	
F250 SUPER DUTY	4x4	Crew Cab	No	8.0 Box	6.0L D	5600	6100	10000		33259	2,10	550	600	550	600	550	850	950	---	n/a	---	---	---	
F250 SUPER DUTY	4x4	Crew Cab	No	8.0 Box	6.8L V10	5600	6100	9800		33259	2,10	350	400	350	400	400	450	500	500	n/a	---	---	---	
F250 SUPER DUTY	4x4	Crew Cab	No	8.0 Box	6.8L V10	5200	6100	9800		33259	2,10	350	400	400	400	500	600	700	800	n/a	---	---	---	
F350 SUPER DUTY	4x4	Reg Cab	No	8.0 Box	5.4L V8	5600	7000	10000		33259	2,10	350	400	350	400	350	450	500	500	n/a	---	---	---	
F350 SUPER DUTY	4x4	Reg Cab	No	8.0 Box	5.4L V8	5600	6390	10000		33259	2,10	350	400	350	400	350	450	500	500	n/a	---	---	---	
F350 SUPER DUTY	4x4	Reg Cab	No	8.0 Box	5.4L V8	5200	7000	10000		33259	2,10	350	400	350	400	350	450	500	500	n/a	---	---	---	
F350 SUPER DUTY	4x4	Reg Cab	No	8.0 Box	5.4L V8	5200	6390	10000		33259	2,10	350	400	350	400	350	450	500	500	n/a	---	---	---	
F350 SUPER DUTY	4x4	Reg Cab	No	8.0 Box	5.4L V8	4800	7000	10000		33259	2,10	350	400	350	400	350	500	600	650	n/a	---	---	---	
F350 SUPER DUTY	4x4	Reg Cab	No	8.0 Box	5.4L V8	4800	6390	10000		33259	2,10	350	400	350	400	350	500	600	650	n/a	---	---	---	
F350 SUPER DUTY	4x4	Reg Cab	No	8.0 Box	6.0L D	6000	7000	10600		33259	2,10	550	600	550	600	600	650	700	700	n/a	---	---	---	
F350 SUPER DUTY	4x4	Reg Cab	No	8.0 Box	6.0L D	6000	7000	10000		33259	2,10	550	600	550	600	600	650	700	700	n/a	---	---	---	
F350 SUPER DUTY	4x4	Reg Cab	No	8.0 Box	6.0L D	6000	6390	10600		33259	2,10	550	600	550	600	600	650	700	700	n/a	---	---	---	
F350 SUPER DUTY	4x4	Reg Cab	No	8.0 Box	6.0L D	6000	6390	10000		33259	2,10	550	600	550	600	600	650	700	700	n/a	---	---	---	
F350 SUPER DUTY	4x4	Reg Cab	No	8.0 Box	6.0L D	5600	7000	10000		33259	2,10	550	600	550	600	600	650	700	700	n/a	---	---	---	
F350 SUPER DUTY	4x4	Reg Cab	No	8.0 Box	6.0L D	5600	7000	10600		33259	2,10	550	600	550	600	600	650	700	700	n/a	---	---	---	
F350 SUPER DUTY	4x4	Reg Cab	No	8.0 Box	6.0L D	5200	7000	10600		33259	2,10	550	600	550	600	600	650	700	700	n/a	---	---	---	
F350 SUPER DUTY	4x4	Reg Cab	No	8.0 Box	6.0L D	5200	7000	10000		33259	2,10	550	600	550	600	600	650	700	700	n/a	---	---	---	
F350 SUPER DUTY	4x4	Reg Cab	No	8.0 Box	6.0L D	5200	6390	10000		33259	2,10	550	600	550	600	600	650	700	700	n/a	---	---	---	
F350 SUPER DUTY	4x4	Reg Cab	No	8.0 Box	6.0L D	5200	7000	10600		33259	2,10	550	600	550	600	600	650	700	700	n/a	---	---	---	
F350 SUPER DUTY	4x4	Reg Cab	No	8.0 Box	6.0L D	5200	6390	10000		33259	2,10	550	600	550	600	600	650	700	700	n/a	---	---	---	
F350 SUPER DUTY	4x4	Reg Cab	No	8.0 Box	6.8L V10	5600	7000	10200		33259	2,10	400	450	400	450	450	550	550	550	600	n/a	---	---	---
F350 SUPER DUTY	4x4	Reg Cab	No	8.0 Box	6.8L V10	5600	6390	10200		33259	2,10	400	450	400	450	450	550	550	550	600	n/a	---	---	---
F350 SUPER DUTY	4x4	Reg Cab	No	8.0 Box	6.8L V10	5600	6390	10000		33259	2,10	400	450	400	450	450	550	550	550	600	n/a	---	---	---
F350 SUPER DUTY	4x4	Reg Cab	No	8.0 Box	6.8L V10	5200	7000	10200		33259	2,10	400	450	400	450	450	550	550	550	600	n/a	---	---	---
F350 SUPER DUTY	4x4	Reg Cab	No	8.0 Box	6.8L V10	5200	7000	10000		33259	2,10	400	450	400	450	450	550	550	550	600	n/a	---	---	---
F350 SUPER DUTY	4x4	Reg Cab	No	8.0 Box	6.8L V10	5200	6390	10200		33259	2,10	400	450	400	450	450	550	550	550	600	n/a	---	---	---
F350 SUPER DUTY	4x4	Reg Cab	No	8.0 Box	6.8L V10	5200	6390	10000		33259	2,10	400	450	400	450	450	550	550	550	600	n/a	---	---	---
F350 SUPER DUTY	4x4	Reg Cab	No	8.0 Box	6.8L V10	4800	7000	10000		33259	2,10	400	500	400	500	450	900	1000	---	n/a	---	---	---	
F350 SUPER DUTY	4x4	Reg Cab	No	8.0 Box	6.8L V10	4800	6390	10200		33259	2,10	400	500	400	500	450	900	1000	---	n/a	---	---	---	
F350 SUPER DUTY	4x4	Reg Cab	No	8.0 Box	6.8L V10	4800	6390	10000		33259	2,10	400	500	400	500	450	900	1000	---	n/a	---	---	---	

- Notes:**
- Ballast amounts are based on a "Representative Vehicle," defined in the vehicle selection guide instructions, and must be modified for all other configurations for axle and GVWR compliance.
 - Recommended snowplow prep package whenever available.
 - May require bumper or air dam notching.

2006 Ford

Section 2

PRO-PLOW®, PRO PLUS® & Heavy Weight Blades

UltraMount								
PRO-PLOW®					PRO PLUS®			
7'-6" STEEL	7'-6" POLY	8'-0" STEEL	8'-0" POLY	8'-6" STEEL	7'-6" STEEL	8'-0" STEEL	8'-6" STEEL	9'-0" STEEL
IUTP75	IUTP75	IUTP80	IUTP80	IUTP85	IUTPP75	IUTPP80	IUTPP85	IUTPP90
60381	62400	60390	62450	60308	64750	66980	66974	66901
67950					66490			
67951-2								
64588					64999			
Light Kit					28800			
Choose a Joystick Control or Hand-Held Control					56369			
					56462			

UniMount	
Heavy Weight	
9'-0" STEEL	10'-0" STEEL
IUHW90	IUHW10
62301	62302
62298-1	
62299-1	
64400	
28800	
56369	
56462	

Model	Body Style	DRW	Box Option	Engine Type	Min F G A W R	Min R G A W R	Min G V W R	Harness Kit	UltraMount® system		Ballast Guidelines, lbs (1)								UniMount® system		Ballast Guidelines, lbs (1)			
									Mount Kit	Notes	1	2	3	4	5	6	7	8	9	10	Mount Kit	Notes	1	2
F350 SUPER DUTY	4x4	Reg Cab	Yes	8.0 Box	5.4L V8	5600	9000	12000	33259	2,10	---	---	---	---	150	---	---	250	300	n/a	---	---	---	---
F350 SUPER DUTY	4x4	Reg Cab	Yes	8.0 Box	5.4L V8	5200	9000	12000	33259	2,10	---	---	---	---	150	---	---	250	300	n/a	---	---	---	---
F350 SUPER DUTY	4x4	Reg Cab	Yes	8.0 Box	5.4L V8	4800	9000	12000	33259	2,10	---	---	---	---	200	---	---	850	950	n/a	---	---	---	---
F350 SUPER DUTY	4x4	Reg Cab	Yes	8.0 Box	6.0L D	6000	9000	12600	33259	2,10	---	---	---	---	350	---	---	450	500	n/a	---	---	---	---
F350 SUPER DUTY	4x4	Reg Cab	Yes	8.0 Box	6.0L D	5600	9000	12600	33259	2,10	---	---	---	---	350	---	---	450	500	n/a	---	---	---	---
F350 SUPER DUTY	4x4	Reg Cab	Yes	8.0 Box	6.0L D	5200	9000	12600	33259	2,10	---	---	---	---	950	---	---	---	---	n/a	---	---	---	---
F350 SUPER DUTY	4x4	Reg Cab	Yes	8.0 Box	6.8L V10	5600	9000	12200	33259	2,10	---	---	---	---	200	---	---	300	350	n/a	---	---	---	---
F350 SUPER DUTY	4x4	Reg Cab	Yes	8.0 Box	6.8L V10	5200	9000	12200	33259	2,10	---	---	---	---	200	---	---	300	350	n/a	---	---	---	---
F350 SUPER DUTY	4x4	Reg Cab	Yes	8.0 Box	6.8L V10	4800	9000	12200	33259	2,10	---	---	---	---	650	---	---	---	---	n/a	---	---	---	---
F350 SUPER DUTY	4x4	Super Cab	No	6.8 Box	5.4L V8	5600	6390	10200	33259	2,10	250	300	300	300	300	400	400	400	400	450	n/a	---	---	---
F350 SUPER DUTY	4x4	Super Cab	No	6.8 Box	5.4L V8	5600	6390	10000	33259	2,10	250	300	300	300	300	400	400	400	400	450	n/a	---	---	---
F350 SUPER DUTY	4x4	Super Cab	No	6.8 Box	5.4L V8	5200	6390	10200	33259	2,10	250	300	300	300	300	400	400	400	400	450	n/a	---	---	---
F350 SUPER DUTY	4x4	Super Cab	No	6.8 Box	5.4L V8	5200	6390	10000	33259	2,10	250	300	300	300	300	400	400	400	400	450	n/a	---	---	---
F350 SUPER DUTY	4x4	Super Cab	No	6.8 Box	5.4L V8	4800	6390	10200	33259	2,10	250	400	300	400	350	800	900	1000	---	n/a	---	---	---	
F350 SUPER DUTY	4x4	Super Cab	No	6.8 Box	5.4L V8	4800	6390	10000	33259	2,10	250	400	300	400	350	800	900	1000	---	n/a	---	---	---	
F350 SUPER DUTY	4x4	Super Cab	No	6.8 Box	6.0L D	6000	7000	10800	33259	2,10	500	550	500	550	550	600	650	650	650	650	n/a	---	---	---
F350 SUPER DUTY	4x4	Super Cab	No	6.8 Box	6.0L D	6000	7000	10000	33259	2,10	500	550	500	550	550	600	650	650	650	650	n/a	---	---	---
F350 SUPER DUTY	4x4	Super Cab	No	6.8 Box	6.0L D	6000	6390	10800	33259	2,10	500	550	500	550	550	600	650	650	650	650	n/a	---	---	---
F350 SUPER DUTY	4x4	Super Cab	No	6.8 Box	6.0L D	6000	6390	10000	33259	2,10	500	550	500	550	550	600	650	650	650	650	n/a	---	---	---
F350 SUPER DUTY	4x4	Super Cab	No	6.8 Box	6.0L D	5200	6390	10800	33259	2,10	900	---	1000	---	---	---	---	---	---	n/a	---	---	---	---
F350 SUPER DUTY	4x4	Super Cab	No	6.8 Box	6.0L D	5200	6390	10000	33259	2,10	900	---	1000	---	---	---	---	---	---	n/a	---	---	---	---
F350 SUPER DUTY	4x4	Super Cab	No	6.8 Box	6.8L V10	5600	6390	10400	33259	2,10	350	350	350	400	350	450	450	500	500	n/a	---	---	---	
F350 SUPER DUTY	4x4	Super Cab	No	6.8 Box	6.8L V10	5600	6390	10000	33259	2,10	350	350	350	400	350	450	450	500	500	n/a	---	---	---	
F350 SUPER DUTY	4x4	Super Cab	No	6.8 Box	6.8L V10	5200	6390	10400	33259	2,10	350	350	350	400	350	450	450	500	500	n/a	---	---	---	
F350 SUPER DUTY	4x4	Super Cab	No	6.8 Box	6.8L V10	4800	6390	10400	33259	2,10	550	800	650	850	750	---	---	---	---	n/a	---	---	---	---
F350 SUPER DUTY	4x4	Super Cab	No	6.8 Box	6.8L V10	4800	6390	10000	33259	2,10	550	800	650	850	750	---	---	---	---	n/a	---	---	---	---
F350 SUPER DUTY	4x4	Super Cab	No	8.0 Box	5.4L V8	5200	6390	10400	33259	2,10	300	350	300	350	350	400	450	450	450	450	n/a	---	---	---
F350 SUPER DUTY	4x4	Super Cab	No	8.0 Box	5.4L V8	5200	6390	10000	33259	2,10	300	350	300	350	350	400	450	450	450	450	n/a	---	---	---
F350 SUPER DUTY	4x4	Super Cab	No	8.0 Box	5.4L V8	4800	6390	10400	33259	2,10	550	800	650	850	750	---	---	---	---	n/a	---	---	---	---
F350 SUPER DUTY	4x4	Super Cab	No	8.0 Box	5.4L V8	4800	6390	10000	33259	2,10	550	800	650	850	750	---	---	---	---	n/a	---	---	---	---

- Notes:**
- Ballast amounts are based on a "Representative Vehicle," defined in the vehicle selection guide instructions, and must be modified for all other configurations for axle and GVWR compliance.
 - Recommended snowplow prep package whenever available.
 - May require bumper or air dam notching.

2006 Ford

Section 2 PRO-PLOW®, PRO PLUS® & Heavy Weight Blades

PRO-PLOW®					PRO PLUS®			
7'-6" STEEL	7'-6" POLY	8'-0" STEEL	8'-0" POLY	8'-6" STEEL	7'-6" STEEL	8'-0" STEEL	8'-6" STEEL	9'-0" STEEL
IUTP75	IUTPY75	IUTP80	IUTPY80	IUTP85	IUTPP75	IUTPP80	IUTPP85	IUTPP90
60381	62400	60390	62450	60308	64750	66980	66974	66901
Blade Assembly					66490			
AQ&L Assembly Box 1					67950			
AQ&L Assembly Box 2					67951-2			
Hydraulic Kit					64588			
Light Kit					28800			
Choose a Joystick Control or Hand-Held Control					56369			
					56462			

Heavy Weight	
9'-0" STEEL	10'-0" STEEL
IUHW90	IUHW10
62301	62302
62298-1	
62299-1	
64400	
28800	
56369	
56462	

Model	Body Style	DRW	Box Option	Engine Type	Min FAWR	Min RGAWR	Min GVWR	Harness Kit	UltraMount® system		Ballast Guidelines, lbs (1)								UniMount® system		Ballast Guidelines, lbs (1)					
									Mount Kit	Notes	1	2	3	4	5	6	7	8	9	10	Mount Kit	Notes				
F350 SUPER DUTY	4x4	Super Cab	No	8.0 Box	6.0L D	6000	6390	11000		33259	2,10	550	550	550	550	650	650	650	700	n/a	---	---	---			
F350 SUPER DUTY	4x4	Super Cab	No	8.0 Box	6.0L D	6000	6390	10000		33259	2,10	550	550	550	550	650	650	650	700	n/a	---	---	---			
F350 SUPER DUTY	4x4	Super Cab	No	8.0 Box	6.0L D	5600	6390	11000		33259	2,10	550	550	550	550	650	650	650	750	n/a	---	---	---			
F350 SUPER DUTY	4x4	Super Cab	No	8.0 Box	6.0L D	5600	6390	10000		33259	2,10	550	550	550	550	650	650	650	750	n/a	---	---	---			
F350 SUPER DUTY	4x4	Super Cab	No	8.0 Box	6.8L V10	5600	6390	10600		33259	2,10	350	400	400	400	500	500	500	500	n/a	---	---	---			
F350 SUPER DUTY	4x4	Super Cab	No	8.0 Box	6.8L V10	5600	6390	10000		33259	2,10	350	400	400	400	500	500	500	500	n/a	---	---	---			
F350 SUPER DUTY	4x4	Super Cab	No	8.0 Box	6.8L V10	5200	6390	10600		33259	2,10	350	400	400	400	500	500	500	500	n/a	---	---	---			
F350 SUPER DUTY	4x4	Super Cab	No	8.0 Box	6.8L V10	5200	6390	10000		33259	2,10	350	400	400	400	500	500	500	500	n/a	---	---	---			
F350 SUPER DUTY	4x4	Super Cab	Yes	8.0 Box	5.4L V8	5600	9000	12400		33259	2,10	---	---	---	---	0	---	---	50	100	n/a	---	---	---		
F350 SUPER DUTY	4x4	Super Cab	Yes	8.0 Box	5.4L V8	5200	9000	12400		33259	2,10	---	---	---	---	0	---	---	50	100	n/a	---	---	---		
F350 SUPER DUTY	4x4	Super Cab	Yes	8.0 Box	6.0L D	6000	9000	13000		33259	2,10	---	---	---	---	300	---	---	450	450	n/a	---	---	---		
F350 SUPER DUTY	4x4	Super Cab	Yes	8.0 Box	6.0L D	5600	9000	13000		33259	2,10	---	---	---	---	300	---	---	850	950	n/a	---	---	---		
F350 SUPER DUTY	4x4	Super Cab	Yes	8.0 Box	6.8L V10	6000	9000	12600		33259	2,10	---	---	---	---	150	---	---	250	300	n/a	---	---	---		
F350 SUPER DUTY	4x4	Super Cab	Yes	8.0 Box	6.8L V10	5600	9000	12600		33259	2,10	---	---	---	---	150	---	---	250	300	n/a	---	---	---		
F350 SUPER DUTY	4x4	Super Cab	Yes	8.0 Box	6.8L V10	5200	9000	12600		33259	2,10	---	---	---	---	150	---	---	650	750	n/a	---	---	---		
F350 SUPER DUTY	4x4	Crew Cab	No	6.8 Box	5.4L V8	5600	6390	10400		33259	2,10	250	300	300	300	400	400	400	400	n/a	---	---	---			
F350 SUPER DUTY	4x4	Crew Cab	No	6.8 Box	5.4L V8	5600	6390	10000		33259	2,10	250	300	300	300	400	400	400	400	n/a	---	---	---			
F350 SUPER DUTY	4x4	Crew Cab	No	6.8 Box	5.4L V8	5200	6390	10400		33259	2,10	250	300	300	300	400	400	400	400	n/a	---	---	---			
F350 SUPER DUTY	4x4	Crew Cab	No	6.8 Box	5.4L V8	4800	6390	10400		33259	2,10	250	300	300	300	400	400	400	400	n/a	---	---	---			
F350 SUPER DUTY	4x4	Crew Cab	No	6.8 Box	5.4L V8	4800	6390	10000		33259	2,10	600	800	700	850	750	---	---	---	---	n/a	---	---	---		
F350 SUPER DUTY	4x4	Crew Cab	No	6.8 Box	5.4L V8	4800	6390	10000		33259	2,10	600	800	700	850	750	---	---	---	---	n/a	---	---	---		
F350 SUPER DUTY	4x4	Crew Cab	No	6.8 Box	6.0L D	6000	6390	11000		33259	2,10	500	550	500	550	600	600	600	650	650	n/a	---	---	---		
F350 SUPER DUTY	4x4	Crew Cab	No	6.8 Box	6.0L D	5600	6390	11000		33259	2,10	500	550	500	550	600	600	600	650	700	n/a	---	---	---		
F350 SUPER DUTY	4x4	Crew Cab	No	6.8 Box	6.0L D	5600	6390	10000		33259	2,10	500	550	500	550	600	600	600	650	700	n/a	---	---	---		
F350 SUPER DUTY	4x4	Crew Cab	No	6.8 Box	6.8L V10	5600	6390	10600		33259	2,10	300	350	350	350	450	450	450	500	n/a	---	---	---			
F350 SUPER DUTY	4x4	Crew Cab	No	6.8 Box	6.8L V10	5600	6390	10000		33259	2,10	300	350	350	350	450	450	450	500	n/a	---	---	---			
F350 SUPER DUTY	4x4	Crew Cab	No	6.8 Box	6.8L V10	5200	6390	10600		33259	2,10	300	350	350	350	450	450	450	500	n/a	---	---	---			
F350 SUPER DUTY	4x4	Crew Cab	No	6.8 Box	6.8L V10	5200	6390	10000		33259	2,10	300	350	350	350	450	450	450	500	n/a	---	---	---			
F350 SUPER DUTY	4x4	Crew Cab	No	8.0 Box	5.4L V8	5600	6390	10600		33259	2,10	300	350	300	350	400	450	450	450	n/a	---	---	---			
F350 SUPER DUTY	4x4	Crew Cab	No	8.0 Box	5.4L V8	5600	6390	10000		33259	2,10	300	350	300	350	400	450	450	450	n/a	---	---	---			
F350 SUPER DUTY	4x4	Crew Cab	No	8.0 Box	5.4L V8	5200	6390	10600		33259	2,10	300	350	300	350	400	450	450	450	n/a	---	---	---			
F350 SUPER DUTY	4x4	Crew Cab	No	8.0 Box	5.4L V8	5200	6390	10000		33259	2,10	300	350	300	350	400	450	450	450	n/a	---	---	---			

- Notes:**
- Ballast amounts are based on a "Representative Vehicle," defined in the vehicle selection guide instructions, and must be modified for all other configurations for axle and GVWR compliance.
 - Recommended snowplow prep package whenever available.
 - May require bumper or air dam notching.

2006 Ford

Section 2 PRO-PLOW®, PRO PLUS® & Heavy Weight Blades

PRO-PLOW®					PRO PLUS®			
7'-6" STEEL	7'-6" POLY	8'-0" STEEL	8'-0" POLY	8'-6" STEEL	7'-6" STEEL	8'-0" STEEL	8'-6" STEEL	9'-0" STEEL
IUTP75	IUTP75	IUTP80	IUTPY80	IUTP85	IUTPP75	IUTPP80	IUTPP85	IUTPP90
60381	62400	60390	62450	60308	64750	66980	66974	66901
67950					66490			
67951-2					64588			
64588					64999			
28800					28800			
56369					56369			
56462					56462			

Heavy Weight	
9'-0" STEEL	10'-0" STEEL
IUHW90	IUHW10
62301	62302
62298-1	
62299-1	
64400	
28800	
56369	
56462	

Model	Body Style	DRW	Box Option	Engine Type	Min F G A W R	Min R G A W R	Min G V W R	Harness Kit	UltraMount® system		Ballast Guidelines, lbs (1)								UniMount® system		Ballast Guidelines, lbs (1)				
									Mount Kit	Notes	Mount Kit	Notes	Mount Kit	Notes	Mount Kit	Notes	Mount Kit	Notes							
F350 SUPER DUTY	4x4	Crew Cab	No	8.0 Box	6.0L D	6000	6390	11200			33259	2,10	500	550	550	550	650	650	650	700	n/a	---	---	---	
F350 SUPER DUTY	4x4	Crew Cab	No	8.0 Box	6.0L D	6000	6390	10000			33259	2,10	500	550	550	550	650	650	650	700	n/a	---	---	---	
F350 SUPER DUTY	4x4	Crew Cab	No	8.0 Box	6.0L D	5600	6390	11200			33259	2,10	500	550	550	550	850	950	---	---	n/a	---	---	---	
F350 SUPER DUTY	4x4	Crew Cab	No	8.0 Box	6.0L D	5600	6390	10000			33259	2,10	500	550	550	550	850	950	---	---	n/a	---	---	---	
F350 SUPER DUTY	4x4	Crew Cab	No	8.0 Box	6.8L V10	5600	6390	10800			33259	2,10	350	400	350	400	450	500	500	500	n/a	---	---	---	
F350 SUPER DUTY	4x4	Crew Cab	No	8.0 Box	6.8L V10	5600	6390	10000			33259	2,10	350	400	350	400	400	450	500	500	500	n/a	---	---	---
F350 SUPER DUTY	4x4	Crew Cab	No	8.0 Box	6.8L V10	5200	6390	10800			33259	2,10	350	400	350	400	400	500	600	700	800	n/a	---	---	---
F350 SUPER DUTY	4x4	Crew Cab	No	8.0 Box	6.8L V10	5200	6390	10000			33259	2,10	350	400	350	400	500	600	700	800	n/a	---	---	---	
F350 SUPER DUTY	4x4	Crew Cab	Yes	6.8 Box	6.0L D	6000	9000	13000			33259	2,10	---	---	---	300	---	---	400	400	n/a	---	---	---	
F350 SUPER DUTY	4x4	Crew Cab	Yes	6.8 Box	6.0L D	5600	9000	13000			33259	2,10	---	---	---	300	---	---	850	950	n/a	---	---	---	
F350 SUPER DUTY	4x4	Crew Cab	Yes	6.8 Box	6.8L V10	5600	9000	12600			33259	2,10	---	---	---	100	---	---	200	250	n/a	---	---	---	
F350 SUPER DUTY	4x4	Crew Cab	Yes	6.8 Box	6.8L V10	5200	9000	12600			33259	2,10	---	---	---	100	---	---	500	600	n/a	---	---	---	
F350 SUPER DUTY	4x4	Crew Cab	Yes	8.0 Box	6.0L D	6000	9000	13000			33259	2,10	---	---	---	300	---	---	400	450	n/a	---	---	---	
F350 SUPER DUTY	4x4	Crew Cab	Yes	8.0 Box	6.0L D	5600	9000	13000			33259	2,10	---	---	---	550	---	---	---	---	n/a	---	---	---	
F350 SUPER DUTY	4x4	Crew Cab	Yes	8.0 Box	6.8L V10	6000	9000	12600			33259	2,10	---	---	---	150	---	---	250	250	n/a	---	---	---	
F350 SUPER DUTY	4x4	Crew Cab	Yes	8.0 Box	6.8L V10	5600	9000	12600			33259	2,10	---	---	---	150	---	---	250	250	n/a	---	---	---	
F350 SUPER DUTY	4x4	Crew Cab	Yes	8.0 Box	6.8L V10	5200	9000	12600			33259	2,10	---	---	---	200	---	---	900	1000	n/a	---	---	---	
F350 SUPER DUTY	4x4	All	No	Chassis	All	All	All	8501	H13 use 28400 or 2B use 8439		33259	2,10	?	?	?	?	?	?	?	?	n/a	---	---	---	
F350 SUPER DUTY	4x2	Reg Cab	No	8.0 Box	6.0L D	4700	7000	10200			33259	2,10,44	900	---	1000	---	---	---	---	---	n/a	---	---	---	
F350 SUPER DUTY	4x2	Reg Cab	No	8.0 Box	6.0L D	4700	6390	10200			33259	2,10,44	900	---	1000	---	---	---	---	---	n/a	---	---	---	
F350 SUPER DUTY	4x2	Reg Cab	No	8.0 Box	6.8L V10	4400	7000	10100			33259	2,10,44	300	450	350	500	400	900	950	---	n/a	---	---	---	
F350 SUPER DUTY	4x2	Reg Cab	No	8.0 Box	6.8L V10	4400	6390	10100			33259	2,10,44	300	450	350	500	400	900	950	---	n/a	---	---	---	
F350 SUPER DUTY	4x2	Reg Cab	No	8.0 Box	6.8L V10	4250	7000	10100			33259	2,10,44	750	1000	850	---	950	---	---	---	n/a	---	---	---	
F350 SUPER DUTY	4x2	Reg Cab	No	8.0 Box	6.8L V10	4250	6390	10100			33259	2,10,44	750	1000	850	---	950	---	---	---	n/a	---	---	---	
F350 SUPER DUTY	4x2	Reg Cab	Yes	8.0 Box	5.4L V8	4250	9000	11800			33259	2,10,44	---	---	---	700	---	---	---	---	n/a	---	---	---	
F350 SUPER DUTY	4x2	Reg Cab	Yes	8.0 Box	6.0L D	4850	9000	12400			33259	2,10,44	---	---	---	700	---	---	---	---	n/a	---	---	---	
F350 SUPER DUTY	4x2	Reg Cab	Yes	8.0 Box	6.8L V10	4400	9000	12000			33259	2,10,44	---	---	---	600	---	---	---	---	n/a	---	---	---	
F350 SUPER DUTY	4x2	Super Cab	No	6.8 Box	6.0L D	4850	7000	10400			33259	2,10,44	700	950	800	950	900	---	---	---	n/a	---	---	---	
F350 SUPER DUTY	4x2	Super Cab	No	6.8 Box	6.0L D	4850	6390	10400			33259	2,10,44	700	950	800	950	900	---	---	---	n/a	---	---	---	
F350 SUPER DUTY	4x2	Super Cab	No	6.8 Box	6.8L V10	4400	7000	10100			33259	2,10,44	500	750	600	800	700	---	---	---	n/a	---	---	---	
F350 SUPER DUTY	4x2	Super Cab	No	6.8 Box	6.8L V10	4400	6390	10100			33259	2,10,44	500	750	600	800	700	---	---	---	n/a	---	---	---	
F350 SUPER DUTY	4x2	Super Cab	No	8.0 Box	5.4L V8	4550	7000	10100			33259	2,10,44	150	200	200	200	200	600	700	800	900	n/a	---	---	---
F350 SUPER DUTY	4x2	Super Cab	No	8.0 Box	5.4L V8	4550	6390	10100			33259	2,10,44	150	200	200	200	200	600	700	800	900	n/a	---	---	---
F350 SUPER DUTY	4x2	Super Cab	No	8.0 Box	5.4L V8	4400	7000	10100			33259	2,10,44	500	750	600	800	700	---	---	---	n/a	---	---	---	
F350 SUPER DUTY	4x2	Super Cab	No	8.0 Box	5.4L V8	4400	6390	10100			33259	2,10,44	500	750	600	800	700	---	---	---	n/a	---	---	---	

- Notes:**
- Ballast amounts are based on a "Representative Vehicle," defined in the vehicle selection guide instructions, and must be modified for all other configurations for axle and GVWR compliance.
 - Recommended snowplow prep package whenever available.

- May require bumper or air dam notching.
- Minimum height required from ground to foremost point on frame bottom is 22.5".

2006 Ford

Section 2 PRO-PLOW®, PRO PLUS® & Heavy Weight Blades

UltraMount								
PRO-PLOW®					PRO PLUS®			
7'-6" STEEL	7'-6" POLY	8'-0" STEEL	8'-0" POLY	8'-6" STEEL	7'-6" STEEL	8'-0" STEEL	8'-6" STEEL	9'-0" STEEL
IUTP75	IUTP75	IUTP80	IUTPY80	IUTP85	IUTPP75	IUTPP80	IUTPP85	IUTPP90
60381	62400	60390	62450	60308	64750	66980	66974	66901
67950					66490			
67951-2								
64588					64999			
28800					28800			
56369					56369			
56462					56462			

UniMount	
Heavy Weight	
9'-0" STEEL	10'-0" STEEL
IUHW90	IUHW10
62301	62302
62298-1	
62299-1	
64400	
28800	
56369	
56462	

Model	Body Style	DRW	Box Option	Engine Type	Min FAWR	Min RGAWR	Min GVWR	Harness Kit	UltraMount® system		Ballast Guidelines, lbs (1)								UniMount® system		Ballast Guidelines, lbs (1)		
									Mount Kit	Notes	1	2	3	4	5	6	7	8	9	10	11	12	13
F350 SUPER DUTY	4x2	Super Cab	No	8.0 Box	6.8L V10	4700	7000	10200	33259	2,10,44	200	250	250	250	250	350	450	550	650	n/a	---	---	---
F350 SUPER DUTY	4x2	Super Cab	No	8.0 Box	6.8L V10	4700	6390	10200	33259	2,10,44	200	250	250	250	250	350	450	550	650	n/a	---	---	---
F350 SUPER DUTY	4x2	Super Cab	No	8.0 Box	6.8L V10	4550	7000	10200	33259	2,10,44	250	500	400	550	450	1000	---	---	---	n/a	---	---	---
F350 SUPER DUTY	4x2	Super Cab	No	8.0 Box	6.8L V10	4550	6390	10200	33259	2,10,44	250	500	400	550	450	1000	---	---	---	n/a	---	---	---
F350 SUPER DUTY	4x2	Super Cab	No	8.0 Box	6.8L V10	4400	7000	10200	33259	2,10,44	900	---	1000	---	---	---	---	---	---	n/a	---	---	---
F350 SUPER DUTY	4x2	Super Cab	No	8.0 Box	6.8L V10	4400	6390	10200	33259	2,10,44	900	---	1000	---	---	---	---	---	---	n/a	---	---	---
F350 SUPER DUTY	4x2	Super Cab	Yes	8.0 Box	5.4L V8	4700	9000	12200	33259	2,10,44	---	---	---	0	---	---	400	500	---	n/a	---	---	---
F350 SUPER DUTY	4x2	Super Cab	Yes	8.0 Box	5.4L V8	4550	9000	12200	33259	2,10,44	---	---	---	300	---	---	1000	---	---	n/a	---	---	---
F350 SUPER DUTY	4x2	Super Cab	Yes	8.0 Box	5.4L V8	4400	9000	12200	33259	2,10,44	---	---	---	900	---	---	---	---	---	n/a	---	---	---
F350 SUPER DUTY	4x2	Super Cab	Yes	8.0 Box	6.8L V10	4850	9000	12400	33259	2,10,44	---	---	---	0	---	---	150	250	---	n/a	---	---	---
F350 SUPER DUTY	4x2	Super Cab	Yes	8.0 Box	6.8L V10	4700	9000	12400	33259	2,10,44	---	---	---	50	---	---	800	850	---	n/a	---	---	---
F350 SUPER DUTY	4x2	Super Cab	Yes	8.0 Box	6.8L V10	4550	9000	12400	33259	2,10,44	---	---	---	700	---	---	---	---	---	n/a	---	---	---
F350 SUPER DUTY	4x2	Crew Cab	No	6.8 Box	5.4L V8	4550	7000	10100	33259	2,10,44	100	150	150	200	150	650	700	800	900	n/a	---	---	---
F350 SUPER DUTY	4x2	Crew Cab	No	6.8 Box	5.4L V8	4550	6390	10100	33259	2,10,44	100	150	150	200	150	650	700	800	900	n/a	---	---	---
F350 SUPER DUTY	4x2	Crew Cab	No	6.8 Box	5.4L V8	4400	7000	10100	33259	2,10,44	550	800	650	800	750	---	---	---	---	n/a	---	---	---
F350 SUPER DUTY	4x2	Crew Cab	No	6.8 Box	5.4L V8	4400	6390	10100	33259	2,10,44	550	800	650	800	750	---	---	---	---	n/a	---	---	---
F350 SUPER DUTY	4x2	Crew Cab	No	6.8 Box	6.8L V10	4700	7000	10200	33259	2,10,44	200	200	200	250	200	400	500	600	700	n/a	---	---	---
F350 SUPER DUTY	4x2	Crew Cab	No	6.8 Box	6.8L V10	4700	6390	10200	33259	2,10,44	200	200	200	250	200	400	500	600	700	n/a	---	---	---
F350 SUPER DUTY	4x2	Crew Cab	No	6.8 Box	6.8L V10	4550	7000	10200	33259	2,10,44	350	550	450	600	550	---	---	---	---	n/a	---	---	---
F350 SUPER DUTY	4x2	Crew Cab	No	6.8 Box	6.8L V10	4550	6390	10200	33259	2,10,44	350	550	450	600	550	---	---	---	---	n/a	---	---	---
F350 SUPER DUTY	4x2	Crew Cab	No	6.8 Box	6.8L V10	4400	7000	10200	33259	2,10,44	950	---	---	---	---	---	---	---	---	n/a	---	---	---
F350 SUPER DUTY	4x2	Crew Cab	No	6.8 Box	6.8L V10	4400	6390	10200	33259	2,10,44	950	---	---	---	---	---	---	---	---	n/a	---	---	---
F350 SUPER DUTY	4x2	Crew Cab	No	8.0 Box	5.4L V8	4850	7000	10200	33259	2,10,44	150	200	200	200	300	300	300	300	300	n/a	---	---	---
F350 SUPER DUTY	4x2	Crew Cab	No	8.0 Box	5.4L V8	4850	6390	10200	33259	2,10,44	150	200	200	200	300	300	300	300	300	n/a	---	---	---
F350 SUPER DUTY	4x2	Crew Cab	No	8.0 Box	5.4L V8	4700	7000	10200	33259	2,10,44	150	200	200	200	400	550	650	750	---	n/a	---	---	---
F350 SUPER DUTY	4x2	Crew Cab	No	8.0 Box	5.4L V8	4700	6390	10200	33259	2,10,44	150	200	200	200	400	550	650	750	---	n/a	---	---	---
F350 SUPER DUTY	4x2	Crew Cab	No	8.0 Box	5.4L V8	4550	7000	10200	33259	2,10,44	350	600	450	650	550	---	---	---	---	n/a	---	---	---
F350 SUPER DUTY	4x2	Crew Cab	No	8.0 Box	5.4L V8	4550	6390	10200	33259	2,10,44	350	600	450	650	550	---	---	---	---	n/a	---	---	---
F350 SUPER DUTY	4x2	Crew Cab	No	8.0 Box	6.8L V10	4850	7000	10400	33259	2,10,44	200	250	250	250	350	350	400	500	---	n/a	---	---	---
F350 SUPER DUTY	4x2	Crew Cab	No	8.0 Box	6.8L V10	4850	6390	10400	33259	2,10,44	200	250	250	250	350	350	400	500	---	n/a	---	---	---
F350 SUPER DUTY	4x2	Crew Cab	No	8.0 Box	6.8L V10	4700	7000	10400	33259	2,10,44	200	400	250	450	350	900	1000	---	---	n/a	---	---	---
F350 SUPER DUTY	4x2	Crew Cab	No	8.0 Box	6.8L V10	4700	6390	10400	33259	2,10,44	200	400	250	450	350	900	1000	---	---	n/a	---	---	---
F350 SUPER DUTY	4x2	Crew Cab	No	8.0 Box	6.8L V10	4550	7000	10400	33259	2,10,44	800	---	900	---	1000	---	---	---	---	n/a	---	---	---
F350 SUPER DUTY	4x2	Crew Cab	No	8.0 Box	6.8L V10	4550	6390	10400	33259	2,10,44	800	---	900	---	1000	---	---	---	---	n/a	---	---	---

Notes:
 1. Ballast amounts are based on a "Representative Vehicle," defined in the vehicle selection guide instructions, and must be modified for all other configurations for axle and GVWR compliance.
 2. Recommended snowplow prep package whenever available.

10. May require bumper or air dam notching.
 44. Minimum height required from ground to foremost point on frame bottom is 22.5".

2006 Ford

Section 2

PRO-PLOW®, PRO PLUS® & Heavy Weight Blades

PRO-PLOW®					PRO PLUS®			
7'-6" STEEL	7'-6" POLY	8'-0" STEEL	8'-0" POLY	8'-6" STEEL	7'-6" STEEL	8'-0" STEEL	8'-6" STEEL	9'-0" STEEL
IUTP75	IUTPY75	IUTP80	IUTPY80	IUTP85	IUTPP75	IUTPP80	IUTPP85	IUTPP90
60381	62400	60390	62450	60308	64750	66980	66974	66901
Blade Assembly					66490			
AQ&L Assembly Box 1					67950			
AQ&L Assembly Box 2					67951-2			
Hydraulic Kit					64588			
Light Kit					28800			
Choose a Joystick Control or Hand-Held Control					56369			
					56462			

Heavy Weight	
9'-0" STEEL	10'-0" STEEL
IUHW90	IUHW10
62301	62302
62298-1	
62299-1	
64400	
28800	
56369	
56462	

Model	Body Style	DRW	Box Option	Engine Type	Min F G A W R	Min R G A W R	Min G V W R	Harness Kit	UltraMount® system		Ballast Guidelines, lbs (1)								UniMount® system		Ballast Guidelines, lbs (1)		
									Mount Kit	Notes	Mount Kit	Notes	Mount Kit	Notes	Mount Kit	Notes	Mount Kit	Notes					
F350 SUPER DUTY	4x2	Crew Cab	Yes	6.8 Box	6.8L V10	4700	9000	12400	33259	2,10,44	---	---	---	---	250	---	---	950	---	n/a	---	---	---
F350 SUPER DUTY	4x2	Crew Cab	Yes	6.8 Box	6.8L V10	4550	9000	12400	33259	2,10,44	---	---	---	---	850	---	---	---	---	n/a	---	---	---
F350 SUPER DUTY	4x2	Crew Cab	Yes	8.0 Box	6.8L V10	4850	9000	12600	33259	2,10,44	---	---	---	---	0	---	---	650	750	n/a	---	---	---
F350 SUPER DUTY	4x2	Crew Cab	Yes	8.0 Box	6.8L V10	4700	9000	12600	33259	2,10,44	---	---	---	---	550	---	---	---	---	n/a	---	---	---
F350 SUPER DUTY	4x2	All	No	Chassis	All	All	All	10001	33259	2,10,44	?	?	?	?	?	?	?	?	?	n/a	---	---	---
F350 SUPER DUTY	4x2	All	Yes	Chassis	All	All	All	10001	33259	2,10,44	---	---	---	---	?	---	---	?	?	n/a	---	---	---
F350 SUPER DUTY 18" / 20" Tires	4x4	Reg Cab	No	8.0 Box	5.4L V8	5600	7000	10500	33259	2,10	300	350	350	350	350	450	450	500	500	n/a	---	---	---
F350 SUPER DUTY 18" / 20" Tires	4x4	Reg Cab	No	8.0 Box	5.4L V8	5600	7000	10000	33259	2,10	300	350	350	350	350	450	450	500	500	n/a	---	---	---
F350 SUPER DUTY 18" / 20" Tires	4x4	Reg Cab	No	8.0 Box	5.4L V8	5200	7000	10500	33259	2,10	300	350	350	350	350	450	450	500	500	n/a	---	---	---
F350 SUPER DUTY 18" / 20" Tires	4x4	Reg Cab	No	8.0 Box	5.4L V8	5200	7000	10000	33259	2,10	300	350	350	350	350	450	450	500	500	n/a	---	---	---
F350 SUPER DUTY 18" / 20" Tires	4x4	Reg Cab	No	8.0 Box	5.4L V8	4800	7000	10500	33259	2,10	300	350	350	350	350	600	700	750	850	n/a	---	---	---
F350 SUPER DUTY 18" / 20" Tires	4x4	Reg Cab	No	8.0 Box	5.4L V8	4800	7000	10000	33259	2,10	300	350	350	350	350	600	700	750	850	n/a	---	---	---
F350 SUPER DUTY 18" / 20" Tires	4x4	Reg Cab	No	8.0 Box	6.0L D	6000	7000	10000	33259	2,10	550	600	550	600	550	650	650	700	700	n/a	---	---	---
F350 SUPER DUTY 18" / 20" Tires	4x4	Reg Cab	No	8.0 Box	6.0L D	5600	7000	10000	33259	2,10	550	600	550	600	550	650	650	700	700	n/a	---	---	---
F350 SUPER DUTY 18" / 20" Tires	4x4	Reg Cab	No	8.0 Box	6.8L V10	5600	7000	10000	33259	2,10	400	450	400	450	400	500	550	550	550	n/a	---	---	---
F350 SUPER DUTY 18" / 20" Tires	4x4	Reg Cab	No	8.0 Box	6.8L V10	5200	7000	10000	33259	2,10	400	450	400	450	400	500	550	550	550	n/a	---	---	---
F350 SUPER DUTY 18" / 20" Tires	4x4	Super Cab	No	6.8 Box	5.4L V8	5600	7000	10600	33259	2,10	250	300	250	300	300	400	400	400	400	n/a	---	---	---
F350 SUPER DUTY 18" / 20" Tires	4x4	Super Cab	No	6.8 Box	5.4L V8	5200	7000	10000	33259	2,10	250	300	250	300	300	400	400	400	400	n/a	---	---	---
F350 SUPER DUTY 18" / 20" Tires	4x4	Super Cab	No	6.8 Box	5.4L V8	4800	7000	10600	33259	2,10	250	500	350	500	450	900	1000	---	---	n/a	---	---	---
F350 SUPER DUTY 18" / 20" Tires	4x4	Super Cab	No	6.8 Box	5.4L V8	4800	7000	10000	33259	2,10	250	500	350	500	450	900	1000	---	---	n/a	---	---	---
F350 SUPER DUTY 18" / 20" Tires	4x4	Super Cab	No	6.8 Box	6.0L D	6000	7000	11200	33259	2,10	500	500	500	550	500	600	600	650	650	n/a	---	---	---
F350 SUPER DUTY 18" / 20" Tires	4x4	Super Cab	No	6.8 Box	6.0L D	6000	7000	10000	33259	2,10	500	500	500	550	500	600	600	650	650	n/a	---	---	---
F350 SUPER DUTY 18" / 20" Tires	4x4	Super Cab	No	8.0 Box	5.4L V8	5600	7000	10800	33259	2,10	300	350	300	350	300	400	400	450	450	n/a	---	---	---
F350 SUPER DUTY 18" / 20" Tires	4x4	Super Cab	No	8.0 Box	5.4L V8	5600	7000	10000	33259	2,10	300	350	300	350	300	400	400	450	450	n/a	---	---	---
F350 SUPER DUTY 18" / 20" Tires	4x4	Super Cab	No	8.0 Box	5.4L V8	5200	7000	10800	33259	2,10	300	350	300	350	300	400	400	450	450	n/a	---	---	---
F350 SUPER DUTY 18" / 20" Tires	4x4	Super Cab	No	8.0 Box	5.4L V8	5200	7000	10000	33259	2,10	300	350	300	350	300	400	400	450	450	n/a	---	---	---
F350 SUPER DUTY 18" / 20" Tires	4x4	Super Cab	No	8.0 Box	5.4L V8	4800	7000	10800	33259	2,10	650	900	750	950	850	---	---	---	---	n/a	---	---	---
F350 SUPER DUTY 18" / 20" Tires	4x4	Super Cab	No	8.0 Box	5.4L V8	4800	7000	10000	33259	2,10	650	900	750	950	850	---	---	---	---	n/a	---	---	---
F350 SUPER DUTY 18" / 20" Tires	4x4	Super Cab	No	8.0 Box	6.0L D	6000	7000	11400	33259	2,10	500	550	500	550	550	650	650	650	650	n/a	---	---	---
F350 SUPER DUTY 18" / 20" Tires	4x4	Super Cab	No	8.0 Box	6.0L D	6000	7000	10000	33259	2,10	500	550	500	550	550	650	650	650	650	n/a	---	---	---
F350 SUPER DUTY 18" / 20" Tires	4x4	Super Cab	No	8.0 Box	6.0L D	5600	7000	11400	33259	2,10	500	550	500	550	550	650	650	750	850	n/a	---	---	---
F350 SUPER DUTY 18" / 20" Tires	4x4	Super Cab	No	8.0 Box	6.0L D	5600	7000	10000	33259	2,10	500	550	500	550	550	650	650	750	850	n/a	---	---	---
F350 SUPER DUTY 18" / 20" Tires	4x4	Super Cab	No	8.0 Box	6.8L V10	5600	7000	10000	33259	2,10	350	400	350	400	350	450	500	500	500	n/a	---	---	---
F350 SUPER DUTY 18" / 20" Tires	4x4	Super Cab	No	8.0 Box	6.8L V10	5200	7000	10000	33259	2,10	350	400	350	400	350	450	500	500	500	n/a	---	---	---

Notes:
 1. Ballast amounts are based on a "Representative Vehicle," defined in the vehicle selection guide instructions, and must be modified for all other configurations for axle and GVWR compliance.
 2. Recommended snowplow prep package whenever available.

10. May require bumper or air dam notching.
 44. Minimum height required from ground to foremost point on frame bottom is 22.5".

2006 Ford

Section 2

PRO-PLOW®, PRO PLUS® & Heavy Weight Blades

PRO-PLOW®					PRO PLUS®			
7'-6" STEEL	7'-6" POLY	8'-0" STEEL	8'-0" POLY	8'-6" STEEL	7'-6" STEEL	8'-0" STEEL	8'-6" STEEL	9'-0" STEEL
IUTP75	IUTP75	IUTP80	IUTP80	IUTP85	IUTPP75	IUTPP80	IUTPP85	IUTPP90
60381	62400	60390	62450	60308	64750	66980	66974	66901
Blade Assembly					66490			
AQ&L Assembly Box 1					67950			
AQ&L Assembly Box 2					67951-2			
Hydraulic Kit					64588		64999	
Light Kit					28800			
Choose a Joystick Control or Hand-Held Control					56369			
					56462			

Heavy Weight	
9'-0" STEEL	10'-0" STEEL
IUHW90	IUHW10
62301	62302
62298-1	
62299-1	
64400	
28800	
56369	
56462	

Model	Body Style	DRW	Box Option	Engine Type	Min F G A W R	Min R G A W R	Min G V W R	Harness Kit	UltraMount® system		Ballast Guidelines, lbs (1)								UniMount® system		Ballast Guidelines, lbs (1)		
									Mount Kit	Notes	1	2	3	4	5	6	7	8	9	10	Mount Kit	Notes	1
F350 SUPER DUTY 18" / 20" Tires	4x4	Crew Cab	No	6.8 Box	5.4L V8	5600	7000	10800	33259	2,10	250	300	250	300	250	350	400	400	400	n/a	---	---	---
F350 SUPER DUTY 18" / 20" Tires	4x4	Crew Cab	No	6.8 Box	5.4L V8	5600	7000	10000	33259	2,10	250	300	250	300	250	350	400	400	400	n/a	---	---	---
F350 SUPER DUTY 18" / 20" Tires	4x4	Crew Cab	No	6.8 Box	5.4L V8	5200	7000	10800	33259	2,10	250	300	250	300	250	350	400	400	400	n/a	---	---	---
F350 SUPER DUTY 18" / 20" Tires	4x4	Crew Cab	No	6.8 Box	5.4L V8	5200	7000	10000	33259	2,10	250	300	250	300	250	350	400	400	400	n/a	---	---	---
F350 SUPER DUTY 18" / 20" Tires	4x4	Crew Cab	No	6.8 Box	5.4L V8	4800	7000	10800	33259	2,10	700	950	800	950	900	---	---	---	---	n/a	---	---	---
F350 SUPER DUTY 18" / 20" Tires	4x4	Crew Cab	No	6.8 Box	5.4L V8	4800	7000	10000	33259	2,10	700	950	800	950	900	---	---	---	---	n/a	---	---	---
F350 SUPER DUTY 18" / 20" Tires	4x4	Crew Cab	No	6.8 Box	5.4L V8	5200	6900	11400	33259	2,10	450	500	500	500	500	600	600	600	650	n/a	---	---	---
F350 SUPER DUTY 18" / 20" Tires	4x4	Crew Cab	No	6.8 Box	6.0L D	6000	6900	10000	33259	2,10	450	500	500	500	500	600	600	600	650	n/a	---	---	---
F350 SUPER DUTY 18" / 20" Tires	4x4	Crew Cab	No	6.8 Box	6.0L D	5600	6900	11400	33259	2,10	450	500	500	500	500	600	650	750	850	n/a	---	---	---
F350 SUPER DUTY 18" / 20" Tires	4x4	Crew Cab	No	6.8 Box	6.0L D	5600	6900	10000	33259	2,10	450	500	500	500	500	600	650	750	850	n/a	---	---	---
F350 SUPER DUTY 18" / 20" Tires	4x4	Crew Cab	No	6.8 Box	6.8L V10	5600	6900	11000	33259	2,10	300	350	300	350	300	400	450	450	450	n/a	---	---	---
F350 SUPER DUTY 18" / 20" Tires	4x4	Crew Cab	No	6.8 Box	6.8L V10	5600	6900	10000	33259	2,10	300	350	300	350	300	400	450	450	450	n/a	---	---	---
F350 SUPER DUTY 18" / 20" Tires	4x4	Crew Cab	No	6.8 Box	6.8L V10	5200	6900	11000	33259	2,10	300	350	300	350	300	400	450	450	500	n/a	---	---	---
F350 SUPER DUTY 18" / 20" Tires	4x4	Crew Cab	No	6.8 Box	6.8L V10	5200	6900	10000	33259	2,10	300	350	300	350	300	400	450	450	500	n/a	---	---	---
F350 SUPER DUTY 18" / 20" Tires	4x4	Crew Cab	No	8.0 Box	5.4L V8	6000	7000	11000	33259	2,10	300	300	300	350	300	400	400	450	450	n/a	---	---	---
F350 SUPER DUTY 18" / 20" Tires	4x4	Crew Cab	No	8.0 Box	5.4L V8	6000	7000	10000	33259	2,10	300	300	300	350	300	400	400	450	450	n/a	---	---	---
F350 SUPER DUTY 18" / 20" Tires	4x4	Crew Cab	No	8.0 Box	5.4L V8	5600	7000	10000	33259	2,10	300	300	300	350	300	400	400	450	450	n/a	---	---	---
F350 SUPER DUTY 18" / 20" Tires	4x4	Crew Cab	No	8.0 Box	5.4L V8	5600	7000	10000	33259	2,10	300	300	300	350	300	400	400	450	450	n/a	---	---	---
F350 SUPER DUTY 18" / 20" Tires	4x4	Crew Cab	No	8.0 Box	5.4L V8	5200	7000	11000	33259	2,10	300	300	300	350	300	400	400	450	450	n/a	---	---	---
F350 SUPER DUTY 18" / 20" Tires	4x4	Crew Cab	No	8.0 Box	5.4L V8	5200	7000	10000	33259	2,10	300	300	300	350	300	400	400	450	450	n/a	---	---	---
F350 SUPER DUTY 18" / 20" Tires	4x4	Crew Cab	No	8.0 Box	6.0L D	6000	6900	11500	33259	2,10	500	550	500	550	550	600	650	650	650	n/a	---	---	---
F350 SUPER DUTY 18" / 20" Tires	4x4	Crew Cab	No	8.0 Box	6.0L D	6000	6900	10000	33259	2,10	500	550	500	550	550	600	650	650	650	n/a	---	---	---
F350 SUPER DUTY 18" / 20" Tires	4x4	Crew Cab	No	8.0 Box	6.0L D	5600	6900	11500	33259	2,10	500	550	500	550	550	1000	---	---	---	n/a	---	---	---
F350 SUPER DUTY 18" / 20" Tires	4x4	Crew Cab	No	8.0 Box	6.0L D	5600	6900	10000	33259	2,10	500	550	500	550	550	1000	---	---	---	n/a	---	---	---
F350 SUPER DUTY 18" / 20" Tires	4x4	Crew Cab	No	8.0 Box	6.8L V10	5600	6900	11200	33259	2,10	350	350	350	350	350	450	450	450	500	n/a	---	---	---
F350 SUPER DUTY 18" / 20" Tires	4x4	Crew Cab	No	8.0 Box	6.8L V10	5600	6900	10000	33259	2,10	350	350	350	350	350	450	450	450	500	n/a	---	---	---
F350 SUPER DUTY 18" / 20" Tires	4x4	Crew Cab	No	8.0 Box	6.8L V10	5200	6900	11200	33259	2,10	350	350	350	350	350	600	700	800	900	n/a	---	---	---
F350 SUPER DUTY 18" / 20" Tires	4x4	Crew Cab	No	8.0 Box	6.8L V10	5200	6900	10000	33259	2,10	350	350	350	350	350	600	700	800	900	n/a	---	---	---
F350 SUPER DUTY 18" / 20" Tires	4x2	Reg Cab	No	8.0 Box	6.0L D	4850	7000	10700	33259	2,10,44	450	700	550	700	650	---	---	---	---	n/a	---	---	---
F350 SUPER DUTY 18" / 20" Tires	4x2	Reg Cab	No	8.0 Box	6.0L D	4850	6830	10700	33259	2,10,44	450	700	550	700	650	---	---	---	---	n/a	---	---	---
F350 SUPER DUTY 18" / 20" Tires	4x2	Reg Cab	No	8.0 Box	6.0L D	4700	7000	10700	33259	2,10,44	1000	---	---	---	---	---	---	---	---	n/a	---	---	---
F350 SUPER DUTY 18" / 20" Tires	4x2	Reg Cab	No	8.0 Box	6.0L D	4700	6830	10700	33259	2,10,44	1000	---	---	---	---	---	---	---	---	n/a	---	---	---
F350 SUPER DUTY 18" / 20" Tires	4x2	Reg Cab	No	8.0 Box	6.8L V10	4400	7000	10300	33259	2,10,44	350	550	450	600	500	1000	---	---	---	n/a	---	---	---
F350 SUPER DUTY 18" / 20" Tires	4x2	Reg Cab	No	8.0 Box	6.8L V10	4400	6390	10300	33259	2,10,44	350	550	450	600	500	1000	---	---	---	n/a	---	---	---
F350 SUPER DUTY 18" / 20" Tires	4x2	Reg Cab	No	8.0 Box	6.8L V10	4250	7000	10300	33259	2,10,44	850	---	950	---	---	---	---	---	---	n/a	---	---	---
F350 SUPER DUTY 18" / 20" Tires	4x2	Reg Cab	No	8.0 Box	6.8L V10	4250	6390	10300	33259	2,10,44	850	---	950	---	---	---	---	---	---	n/a	---	---	---

Notes:
 1. Ballast amounts are based on a "Representative Vehicle," defined in the vehicle selection guide instructions, and must be modified for all other configurations for axle and GVWR compliance.
 2. Recommended snowplow prep package whenever available.

10. May require bumper or air dam notching.
 44. Minimum height required from ground to foremost point on frame bottom is 22.5".

2006 Ford

Section 2

PRO-PLOW®, PRO PLUS® & Heavy Weight Blades

UltraMount								
PRO-PLOW®					PRO PLUS®			
7'-6" STEEL	7'-6" POLY	8'-0" STEEL	8'-0" POLY	8'-6" STEEL	7'-6" STEEL	8'-0" STEEL	8'-6" STEEL	9'-0" STEEL
IUTP75	IUTPY75	IUTP80	IUTPY80	IUTP85	IUTPP75	IUTPP80	IUTPP85	IUTPP90
60381	62400	60390	62450	60308	64750	66980	66974	66901
67950					66490			
67951-2								
64588					64999			
28800								
56369								
56462								

UniMount	
Heavy Weight	
9'-0" STEEL	10'-0" STEEL
IUHW90	IUHW10
62301	62302
62298-1	
62299-1	
64400	
28800	
56369	
56462	

Model	Body Style	DRW	Box Option	Engine Type	Min FAWR	Min RGAWR	Min GVWR	Harness Kit	UltraMount® system		Ballast Guidelines, lbs (1)								UniMount® system		Ballast Guidelines, lbs (1)		
									Mount Kit	Notes	1	2	3	4	5	6	7	8	9	10	11	12	13
F350 SUPER DUTY 18" / 20" Tires	4x2	Super Cab	No	6.8 Box	5.4L V8	4400	7000	10200	33259	2,10,44	250	500	350	550	450	950	1000	---	---	n/a	---	---	---
F350 SUPER DUTY 18" / 20" Tires	4x2	Super Cab	No	6.8 Box	5.4L V8	4400	6830	10200	33259	2,10,44	250	500	350	550	450	950	1000	---	---	n/a	---	---	---
F350 SUPER DUTY 18" / 20" Tires	4x2	Super Cab	No	6.8 Box	5.4L V8	4250	7000	10200	33259	2,10,44	850	---	900	---	1000	---	---	---	---	n/a	---	---	---
F350 SUPER DUTY 18" / 20" Tires	4x2	Super Cab	No	6.8 Box	5.4L V8	4250	6830	10200	33259	2,10,44	850	---	900	---	1000	---	---	---	---	n/a	---	---	---
F350 SUPER DUTY 18" / 20" Tires	4x2	Super Cab	No	6.8 Box	6.0L D	4850	7000	10800	33259	2,10,44	800	---	900	---	1000	---	---	---	---	n/a	---	---	---
F350 SUPER DUTY 18" / 20" Tires	4x2	Super Cab	No	6.8 Box	6.0L D	4850	6830	10800	33259	2,10,44	800	---	900	---	1000	---	---	---	---	n/a	---	---	---
F350 SUPER DUTY 18" / 20" Tires	4x2	Super Cab	No	6.8 Box	6.8L V10	4400	7000	10400	33259	2,10,44	650	850	750	900	800	---	---	---	---	n/a	---	---	---
F350 SUPER DUTY 18" / 20" Tires	4x2	Super Cab	No	6.8 Box	6.8L V10	4400	6830	10400	33259	2,10,44	650	850	750	900	800	---	---	---	---	n/a	---	---	---
F350 SUPER DUTY 18" / 20" Tires	4x2	Super Cab	No	8.0 Box	5.4L V8	4700	7000	10400	33259	2,10,44	150	200	150	200	200	250	300	300	400	n/a	---	---	---
F350 SUPER DUTY 18" / 20" Tires	4x2	Super Cab	No	8.0 Box	5.4L V8	4700	6830	10400	33259	2,10,44	150	200	150	200	200	250	300	300	400	n/a	---	---	---
F350 SUPER DUTY 18" / 20" Tires	4x2	Super Cab	No	8.0 Box	5.4L V8	4550	7000	10400	33259	2,10,44	150	250	150	300	200	700	800	900	1000	n/a	---	---	---
F350 SUPER DUTY 18" / 20" Tires	4x2	Super Cab	No	8.0 Box	5.4L V8	4550	6830	10400	33259	2,10,44	150	250	150	300	200	700	800	900	1000	n/a	---	---	---
F350 SUPER DUTY 18" / 20" Tires	4x2	Super Cab	No	8.0 Box	5.4L V8	4400	7000	10400	33259	2,10,44	650	900	750	900	850	---	---	---	---	n/a	---	---	---
F350 SUPER DUTY 18" / 20" Tires	4x2	Super Cab	No	8.0 Box	5.4L V8	4400	6830	10400	33259	2,10,44	650	900	750	900	850	---	---	---	---	n/a	---	---	---
F350 SUPER DUTY 18" / 20" Tires	4x2	Super Cab	No	8.0 Box	6.8L V10	4700	7000	10600	33259	2,10,44	200	250	200	250	250	450	550	650	750	n/a	---	---	---
F350 SUPER DUTY 18" / 20" Tires	4x2	Super Cab	No	8.0 Box	6.8L V10	4700	6830	10600	33259	2,10,44	200	250	200	250	250	450	550	650	750	n/a	---	---	---
F350 SUPER DUTY 18" / 20" Tires	4x2	Super Cab	No	8.0 Box	6.8L V10	4550	7000	10600	33259	2,10,44	400	650	500	650	600	---	---	---	---	n/a	---	---	---
F350 SUPER DUTY 18" / 20" Tires	4x2	Super Cab	No	8.0 Box	6.8L V10	4550	6830	10600	33259	2,10,44	400	650	500	650	600	---	---	---	---	n/a	---	---	---
F350 SUPER DUTY 18" / 20" Tires	4x2	Super Cab	No	8.0 Box	6.8L V10	4400	7000	10600	33259	2,10,44	1000	---	---	---	---	---	---	---	---	n/a	---	---	---
F350 SUPER DUTY 18" / 20" Tires	4x2	Super Cab	No	8.0 Box	6.8L V10	4400	6830	10600	33259	2,10,44	1000	---	---	---	---	---	---	---	---	n/a	---	---	---
F350 SUPER DUTY 18" / 20" Tires	4x2	Super Cab	No	8.0 Box	6.8L V10	4400	6830	10600	33259	2,10,44	1000	---	---	---	---	---	---	---	---	n/a	---	---	---
F350 SUPER DUTY 18" / 20" Tires	4x2	Crew Cab	No	6.8 Box	5.4L V8	4550	7000	10400	33259	2,10,44	100	300	150	300	250	750	850	950	---	n/a	---	---	---
F350 SUPER DUTY 18" / 20" Tires	4x2	Crew Cab	No	6.8 Box	5.4L V8	4550	6830	10400	33259	2,10,44	100	300	150	300	250	750	850	950	---	n/a	---	---	---
F350 SUPER DUTY 18" / 20" Tires	4x2	Crew Cab	No	6.8 Box	5.4L V8	4400	7000	10400	33259	2,10,44	650	900	750	950	850	---	---	---	---	n/a	---	---	---
F350 SUPER DUTY 18" / 20" Tires	4x2	Crew Cab	No	6.8 Box	5.4L V8	4400	6830	10400	33259	2,10,44	650	900	750	950	850	---	---	---	---	n/a	---	---	---
F350 SUPER DUTY 18" / 20" Tires	4x2	Crew Cab	No	6.8 Box	6.8L V10	4700	7000	10600	33259	2,10,44	150	200	200	200	200	550	650	750	800	n/a	---	---	---
F350 SUPER DUTY 18" / 20" Tires	4x2	Crew Cab	No	6.8 Box	6.8L V10	4700	6830	10600	33259	2,10,44	150	200	200	200	200	550	650	750	800	n/a	---	---	---
F350 SUPER DUTY 18" / 20" Tires	4x2	Crew Cab	No	6.8 Box	6.8L V10	4550	7000	10600	33259	2,10,44	450	700	550	750	650	---	---	---	---	n/a	---	---	---
F350 SUPER DUTY 18" / 20" Tires	4x2	Crew Cab	No	6.8 Box	6.8L V10	4550	6830	10600	33259	2,10,44	450	700	550	750	650	---	---	---	---	n/a	---	---	---
F350 SUPER DUTY 18" / 20" Tires	4x2	Crew Cab	No	8.0 Box	5.4L V8	4850	7000	10600	33259	2,10,44	150	200	150	200	150	250	250	300	300	n/a	---	---	---
F350 SUPER DUTY 18" / 20" Tires	4x2	Crew Cab	No	8.0 Box	5.4L V8	4850	6830	10600	33259	2,10,44	150	200	150	200	150	250	250	300	300	n/a	---	---	---
F350 SUPER DUTY 18" / 20" Tires	4x2	Crew Cab	No	8.0 Box	5.4L V8	4700	7000	10600	33259	2,10,44	150	200	150	200	150	550	650	750	850	n/a	---	---	---
F350 SUPER DUTY 18" / 20" Tires	4x2	Crew Cab	No	8.0 Box	5.4L V8	4700	6830	10600	33259	2,10,44	150	200	150	200	150	550	650	750	850	n/a	---	---	---
F350 SUPER DUTY 18" / 20" Tires	4x2	Crew Cab	No	8.0 Box	5.4L V8	4550	7000	10600	33259	2,10,44	500	750	600	800	700	---	---	---	---	n/a	---	---	---
F350 SUPER DUTY 18" / 20" Tires	4x2	Crew Cab	No	8.0 Box	5.4L V8	4550	6830	10600	33259	2,10,44	500	750	600	800	700	---	---	---	---	n/a	---	---	---

Notes:
 1. Ballast amounts are based on a "Representative Vehicle," defined in the vehicle selection guide instructions, and must be modified for all other configurations for axle and GVWR compliance.
 2. Recommended snowplow prep package whenever available.

10. May require bumper or air dam notching.
 44. Minimum height required from ground to foremost point on frame bottom is 22.5".

2006 Ford

Section 2

PRO-PLOW®, PRO PLUS® & Heavy Weight Blades

UltraMount									
PRO-PLOW®					PRO PLUS®				
7'-6" STEEL	7'-6" POLY	8'-0" STEEL	8'-0" POLY	8'-6" STEEL	7'-6" STEEL	8'-0" STEEL	8'-6" STEEL	9'-0" STEEL	
IUTP75	IUTPY75	IUTP80	IUTPY80	IUTP85	IUTPP75	IUTPP80	IUTPP85	IUTPP90	
60381	62400	60390	62450	60308	64750	66980	66974	66901	
67950					66490				
67951-2									
64588					64999				
Light Kit					28800				
Choose a Joystick Control or Hand-Held Control					56369				
					56462				

UniMount	
Heavy Weight	
9'-0" STEEL	10'-0" STEEL
IUHW90	IUHW10
62301	62302
62298-1	
62299-1	
64400	
28800	
56369	
56462	

Model	Body Style	DRW	Box Option	Engine Type	Min F G A W R	Min R G A W R	Min G V W R	Harness Kit	UltraMount® system		Ballast Guidelines, lbs (1)								UniMount® system		Ballast Guidelines, lbs (1)			
									Mount Kit	Notes	Mount Kit	Notes	Mount Kit	Notes	Mount Kit	Notes	Mount Kit	Notes						
F350 SUPER DUTY 18" / 20" Tires	4x2	Crew Cab	No	8.0 Box	6.8L V10	4850	7000	10800	H13 use 28400 or 2B use 8439	33259	2,10,44	200	250	200	250	250	350	450	550	650	n/a	---	---	---
F350 SUPER DUTY 18" / 20" Tires	4x2	Crew Cab	No	8.0 Box	6.8L V10	4850	6830	10800		33259	2,10,44	200	250	200	250	250	350	450	550	650	n/a	---	---	---
F350 SUPER DUTY 18" / 20" Tires	4x2	Crew Cab	No	8.0 Box	6.8L V10	4700	7000	10800		33259	2,10,44	250	500	350	550	450	1000	---	---	---	n/a	---	---	---
F350 SUPER DUTY 18" / 20" Tires	4x2	Crew Cab	No	8.0 Box	6.8L V10	4700	6830	10800		33259	2,10,44	250	500	350	550	450	1000	---	---	---	n/a	---	---	---
F350 SUPER DUTY 18" / 20" Tires	4x2	Crew Cab	No	8.0 Box	6.8L V10	4550	7000	10800		33259	2,10,44	950	---	---	---	---	---	---	---	---	n/a	---	---	---
F350 SUPER DUTY 18" / 20" Tires	4x2	Crew Cab	No	8.0 Box	6.8L V10	4550	6830	10800		33259	2,10,44	950	---	---	---	---	---	---	---	---	n/a	---	---	---
F450 SUPER DUTY	4x4	All	Yes	Chassis	All	All	All	15000		33259	2,10	---	---	---	---	---	---	---	?	?	n/a	---	---	---
F450 SUPER DUTY	4x2	All	Yes	Chassis	All	All	All	15000		33259	2,10,44	---	---	---	---	---	---	---	?	?	n/a	---	---	---
F550 SUPER DUTY	4x4	All	Yes	Chassis	All	All	All	15000		33259	2,10	---	---	---	---	---	---	---	?	?	n/a	---	---	---
F550 SUPER DUTY	4x2	All	Yes	Chassis	All	All	All	15000		33259	2,10,44	---	---	---	---	---	---	---	?	?	n/a	---	---	---
F650	4x2	All	Yes	Chassis	All	All	All	10001	2B use 8439 & 26640 or HB5 use 8436 & 26640	n/a	---	---	---	---	---	---	---	---	---	62275	---	?	?	

- Notes:**
- Ballast amounts are based on a "Representative Vehicle," defined in the vehicle selection guide instructions, and must be modified for all other configurations for axle and GVWR compliance.
 - Recommended snowplow prep package whenever available.

- May require bumper or air dam notching.
- Minimum height required from ground to foremost point on frame bottom is 22.5".

2006 Ford

Section 3 MVP® & MVP PLUS™ Blades

MVP®	MVP PLUS™					
8'-6" STEEL	7'-6" STEEL	7'-6" POLY	8'-6" STEEL	8'-6" POLY	9'-6" STEEL	9'-6" POLY
IUMV85	IUTHVPP75	IUTHVPP75	IUTHVPP85	IUTHVPP85	IUTHVPP95	IUTHVPP95
Blade Assembly 63819	44475	44575	44485	44585	44495	44595
AQ&L Assembly Box 1 63910	44225					
AQ&L Assembly Box 2 67951-2						
Hydraulic Kit 64777						
Light Kit 28800						
Choose a Joystick Control or Hand-Held Control	96369	96700				96600
	96462					96600

Model	Body Style	DRW	Box Option	Engine Type	Min F G A W R	Min R G A W R	Min G V W R	Harness Kit	UltraMount® system		Ballast 1	Ballast 2	Ballast 3	Ballast 4	Ballast 5	Ballast 6	Ballast 7	Ballast 8
									Mount Kit	Notes								
F150	4x4	Reg Cab	No	8.0 Box	5.4L V8	4300	4800	8200	H13 use 28400	64500	3	---	---	850	---	---	---	---
F250 SUPER DUTY	4x4	Reg Cab	No	8.0 Box	5.4L V8	5600	6100	9000	H13 use 28400 or 2B use 8439	33259	2,10	550	450	400	500	450	600	550
F250 SUPER DUTY	4x4	Reg Cab	No	8.0 Box	5.4L V8	5200	6100	9000		33259	2,10	550	450	400	500	450	600	550
F250 SUPER DUTY	4x4	Reg Cab	No	8.0 Box	5.4L V8	4800	6100	9000		33259	2,10	1000	500	450	800	600	---	---
F250 SUPER DUTY	4x4	Reg Cab	No	8.0 Box	6.0L D	6000	6100	9600		33259	2,10	750	650	650	700	650	800	750
F250 SUPER DUTY	4x4	Reg Cab	No	8.0 Box	6.0L D	5600	6100	9600		33259	2,10	800	700	650	700	700	800	800
F250 SUPER DUTY	4x4	Reg Cab	No	8.0 Box	6.8L V10	5600	6100	9200		33259	2,10	600	500	500	550	500	650	600
F250 SUPER DUTY	4x4	Reg Cab	No	8.0 Box	6.8L V10	5200	6100	9200		33259	2,10	600	500	500	550	500	650	600
F250 SUPER DUTY	4x4	Reg Cab	No	8.0 Box	6.8L V10	4800	6100	9200		33259	2,10	---	950	800	---	---	---	---
F250 SUPER DUTY	4x4	Super Cab	No	6.8 Box	5.4L V8	5600	6100	9200		33259	2,10	450	400	350	400	400	550	500
F250 SUPER DUTY	4x4	Super Cab	No	6.8 Box	5.4L V8	5200	6100	9200		33259	2,10	500	400	400	450	400	550	500
F250 SUPER DUTY	4x4	Super Cab	No	6.8 Box	5.4L V8	4800	6100	9200		33259	2,10	---	850	700	---	950	---	---
F250 SUPER DUTY	4x4	Super Cab	No	6.8 Box	6.0L D	6000	6100	9800		33259	2,10	700	600	600	650	600	750	700
F250 SUPER DUTY	4x4	Super Cab	No	6.8 Box	6.0L D	5600	6100	9800		33259	2,10	750	650	600	650	650	1000	800
F250 SUPER DUTY	4x4	Super Cab	No	6.8 Box	6.8L V10	5600	6100	9400		33259	2,10	550	450	400	500	450	600	550
F250 SUPER DUTY	4x4	Super Cab	No	6.8 Box	6.8L V10	5200	6100	9400		33259	2,10	550	450	450	500	450	700	550
F250 SUPER DUTY	4x4	Super Cab	No	8.0 Box	5.4L V8	5600	6100	9400		33259	2,10	500	400	400	450	400	550	500
F250 SUPER DUTY	4x4	Super Cab	No	8.0 Box	5.4L V8	5200	6100	9400		33259	2,10	550	450	400	450	450	650	550
F250 SUPER DUTY	4x4	Super Cab	No	8.0 Box	6.0L D	6000	6100	10000		33259	2,10	700	650	600	650	650	800	750
F250 SUPER DUTY	4x4	Super Cab	No	8.0 Box	6.0L D	5600	6100	10000		33259	2,10	1000	650	650	800	650	---	---
F250 SUPER DUTY	4x4	Super Cab	No	8.0 Box	6.8L V10	5600	6100	9600		33259	2,10	550	450	450	500	500	600	600
F250 SUPER DUTY	4x4	Super Cab	No	8.0 Box	6.8L V10	5200	6100	9600		33259	2,10	650	500	450	550	500	---	900
F250 SUPER DUTY	4x4	Crew Cab	No	6.8 Box	5.4L V8	5600	6100	9400		33259	2,10	450	350	350	400	400	500	500
F250 SUPER DUTY	4x4	Crew Cab	No	6.8 Box	5.4L V8	5200	6100	9400		33259	2,10	500	400	350	450	400	650	500
F250 SUPER DUTY	4x4	Crew Cab	No	6.8 Box	6.0L D	6000	6100	10000		33259	2,10	700	600	550	650	600	750	700
F250 SUPER DUTY	4x4	Crew Cab	No	6.8 Box	6.0L D	5600	6100	10000		33259	2,10	1000	600	600	750	650	---	---
F250 SUPER DUTY	4x4	Crew Cab	No	6.8 Box	6.8L V10	5600	6100	9600		33259	2,10	500	400	400	450	450	550	550
F250 SUPER DUTY	4x4	Crew Cab	No	6.8 Box	6.8L V10	5200	6100	9600		33259	2,10	650	450	400	500	450	---	900
F250 SUPER DUTY	4x4	Crew Cab	No	8.0 Box	5.4L V8	5600	6100	9600		33259	2,10	500	400	400	450	400	550	500
F250 SUPER DUTY	4x4	Crew Cab	No	8.0 Box	5.4L V8	5200	6100	9600		33259	2,10	600	450	400	450	450	---	850
F250 SUPER DUTY	4x4	Crew Cab	No	8.0 Box	6.0L D	6000	6100	10000		33259	2,10	700	600	600	650	650	750	750
F250 SUPER DUTY	4x4	Crew Cab	No	8.0 Box	6.0L D	5600	6100	10000		33259	2,10	---	950	750	---	---	---	---
F250 SUPER DUTY	4x4	Crew Cab	No	8.0 Box	6.8L V10	5600	6100	9800		33259	2,10	550	450	450	500	450	600	550
F250 SUPER DUTY	4x4	Crew Cab	No	8.0 Box	6.8L V10	5200	6100	9800		33259	2,10	---	550	450	850	650	---	---

- Notes:**
- Ballast amounts are based on a "Representative Vehicle," defined in the vehicle selection guide instructions, and must be modified for all other configurations for axle and GVWR compliance.
 - Recommended snowplow prep package whenever available.

- Requires bumper notching.
- May require bumper or air dam notching.

2006 Ford

Section 3 MVP® & MVP PLUS™ Blades

MVP®	MVP PLUS™					
8'-6" STEEL	7'-6" STEEL	7'-6" POLY	8'-6" STEEL	8'-6" POLY	9'-6" STEEL	9'-6" POLY
IUMVP85	IUTHVPP75	IUTHVPPY75	IUTHMVP85	IUTHMVPY85	IUTHMVP95	IUTHMVPY95
Blade Assembly 63819	44475	44575	44485	44585	44495	44595
AQ&L Assembly Box 1 63910	44225					
AQ&L Assembly Box 2 67951-2						
Hydraulic Kit 64777						
Light Kit 28800						
Choose a Joystick Control or Hand-Held Control	96369	96700				96600
	96462					96600

Model	Body Style	DRW	Box Option	Engine Type	Min FAWR	Min RAWR	Min GVWR	Harness Kit	UltraMount® system		Plow								
									Mount Kit	Notes	IUMVP85	IUTHVPP75	IUTHVPPY75	IUTHMVP85	IUTHMVPY85	IUTHMVP95	IUTHMVPY95		
F350 SUPER DUTY	4x4	Reg Cab	No	8.0 Box	5.4L V8	5600	7000	10000			33259	2,10	550	450	400	500	450	600	550
F350 SUPER DUTY	4x4	Reg Cab	No	8.0 Box	5.4L V8	5600	6390	10000			33259	2,10	550	450	400	500	450	600	550
F350 SUPER DUTY	4x4	Reg Cab	No	8.0 Box	5.4L V8	5200	7000	10000			33259	2,10	550	450	400	500	450	600	550
F350 SUPER DUTY	4x4	Reg Cab	No	8.0 Box	5.4L V8	5200	6390	10000			33259	2,10	550	450	400	500	450	600	550
F350 SUPER DUTY	4x4	Reg Cab	No	8.0 Box	5.4L V8	4800	7000	10000			33259	2,10	1000	500	400	800	600	---	---
F350 SUPER DUTY	4x4	Reg Cab	No	8.0 Box	5.4L V8	4800	6390	10000			33259	2,10	1000	500	400	800	600	---	---
F350 SUPER DUTY	4x4	Reg Cab	No	8.0 Box	6.0L D	6000	7000	10600			33259	2,10	750	650	650	700	650	800	750
F350 SUPER DUTY	4x4	Reg Cab	No	8.0 Box	6.0L D	6000	7000	10000			33259	2,10	750	650	650	700	650	800	750
F350 SUPER DUTY	4x4	Reg Cab	No	8.0 Box	6.0L D	6000	6390	10600			33259	2,10	750	650	650	700	650	800	750
F350 SUPER DUTY	4x4	Reg Cab	No	8.0 Box	6.0L D	6000	6390	10000			33259	2,10	750	650	650	700	650	800	750
F350 SUPER DUTY	4x4	Reg Cab	No	8.0 Box	6.0L D	5600	7000	10600			33259	2,10	750	650	650	700	650	800	750
F350 SUPER DUTY	4x4	Reg Cab	No	8.0 Box	6.0L D	5600	7000	10000			33259	2,10	750	650	650	700	650	800	750
F350 SUPER DUTY	4x4	Reg Cab	No	8.0 Box	6.0L D	5600	6390	10600			33259	2,10	750	650	650	700	650	800	750
F350 SUPER DUTY	4x4	Reg Cab	No	8.0 Box	6.0L D	5600	6390	10000			33259	2,10	750	650	650	700	650	800	750
F350 SUPER DUTY	4x4	Reg Cab	No	8.0 Box	6.8L V10	5600	7000	10200			33259	2,10	600	500	500	550	550	650	650
F350 SUPER DUTY	4x4	Reg Cab	No	8.0 Box	6.8L V10	5600	7000	10000			33259	2,10	600	500	500	550	550	650	650
F350 SUPER DUTY	4x4	Reg Cab	No	8.0 Box	6.8L V10	5600	6390	10200			33259	2,10	600	500	500	550	550	650	650
F350 SUPER DUTY	4x4	Reg Cab	No	8.0 Box	6.8L V10	5600	6390	10000			33259	2,10	600	500	500	550	550	650	650
F350 SUPER DUTY	4x4	Reg Cab	No	8.0 Box	6.8L V10	5200	7000	10200			33259	2,10	600	500	500	550	550	650	650
F350 SUPER DUTY	4x4	Reg Cab	No	8.0 Box	6.8L V10	5200	7000	10000			33259	2,10	600	500	500	550	550	650	650
F350 SUPER DUTY	4x4	Reg Cab	No	8.0 Box	6.8L V10	5200	6390	10200			33259	2,10	600	500	500	550	550	650	650
F350 SUPER DUTY	4x4	Reg Cab	No	8.0 Box	6.8L V10	5200	6390	10000			33259	2,10	600	500	500	550	550	650	650
F350 SUPER DUTY	4x4	Reg Cab	No	8.0 Box	6.8L V10	4800	7000	10000			33259	2,10	---	950	800	---	---	---	---
F350 SUPER DUTY	4x4	Reg Cab	No	8.0 Box	6.8L V10	4800	7000	10000			33259	2,10	---	950	800	---	---	---	---
F350 SUPER DUTY	4x4	Reg Cab	No	8.0 Box	6.8L V10	4800	6390	10200			33259	2,10	---	950	800	---	---	---	---
F350 SUPER DUTY	4x4	Reg Cab	No	8.0 Box	6.8L V10	4800	6390	10000			33259	2,10	---	950	800	---	---	---	---
F350 SUPER DUTY	4x4	Reg Cab	Yes	8.0 Box	5.4L V8	5600	9000	12000			33259	2,10	300	---	---	250	250	350	350
F350 SUPER DUTY	4x4	Reg Cab	Yes	8.0 Box	5.4L V8	5200	9000	12000			33259	2,10	300	---	---	250	250	350	350
F350 SUPER DUTY	4x4	Reg Cab	Yes	8.0 Box	5.4L V8	4800	9000	12000			33259	2,10	---	---	---	950	800	---	---
F350 SUPER DUTY	4x4	Reg Cab	Yes	8.0 Box	6.0L D	6000	9000	12600			33259	2,10	500	---	---	450	450	600	550
F350 SUPER DUTY	4x4	Reg Cab	Yes	8.0 Box	6.0L D	5600	9000	12600			33259	2,10	500	---	---	450	450	900	700
F350 SUPER DUTY	4x4	Reg Cab	Yes	8.0 Box	6.8L V10	5600	9000	12200			33259	2,10	350	---	---	300	300	400	400
F350 SUPER DUTY	4x4	Reg Cab	Yes	8.0 Box	6.8L V10	5200	9000	12200			33259	2,10	350	---	---	300	300	600	400

- Notes:**
- Ballast amounts are based on a "Representative Vehicle," defined in the vehicle selection guide instructions, and must be modified for all other configurations for axle and GVWR compliance.
 - Recommended snowplow prep package whenever available.
 - May require bumper or air dam notching.

2006 Ford

Section 3 MVP® & MVP PLUS™ Blades

MVP®	MVP PLUS™					
8'-6" STEEL	7'-6" STEEL	7'-6" POLY	8'-6" STEEL	8'-6" POLY	9'-6" STEEL	9'-6" POLY
IUMV85	IUTHVPP75	IUTHVPPY75	IUTHVPP85	IUTHVPPY85	IUTHVPP95	IUTHVPPY95
Blade Assembly	63819	44475	44575	44485	44585	44495
AQ&L Assembly Box 1	63910					
AQ&L Assembly Box 2	67951-2	44225				
Hydraulic Kit	64777					
Light Kit	28800					
Choose a Joystick Control or Hand-Held Control	96369	96700				
	96462	96600				

Model	Body Style	DRW	Box Option	Engine Type	Min F G A W R	Min R G A W R	Min G V W R	Harness Kit	UltraMount® system		Blade Assembly								
									Mount Kit	Notes	IUMV85	IUTHVPP75	IUTHVPPY75	IUTHVPP85	IUTHVPPY85	IUTHVPP95	IUTHVPPY95		
F350 SUPER DUTY	4x4	Super Cab	No	6.8 Box	5.4L V8	5600	6390	10200			33259	2,10	450	400	350	400	400	550	500
F350 SUPER DUTY	4x4	Super Cab	No	6.8 Box	5.4L V8	5600	6390	10000			33259	2,10	450	400	350	400	400	550	500
F350 SUPER DUTY	4x4	Super Cab	No	6.8 Box	5.4L V8	5200	6390	10200			33259	2,10	450	400	350	400	400	550	500
F350 SUPER DUTY	4x4	Super Cab	No	6.8 Box	5.4L V8	5200	6390	10000			33259	2,10	450	400	350	400	400	550	500
F350 SUPER DUTY	4x4	Super Cab	No	6.8 Box	5.4L V8	4800	6390	10200			33259	2,10	---	850	700	---	950	---	---
F350 SUPER DUTY	4x4	Super Cab	No	6.8 Box	5.4L V8	4800	6390	10000			33259	2,10	---	850	700	---	950	---	---
F350 SUPER DUTY	4x4	Super Cab	No	6.8 Box	6.0L D	6000	7000	10800			33259	2,10	700	600	600	650	600	750	700
F350 SUPER DUTY	4x4	Super Cab	No	6.8 Box	6.0L D	6000	7000	10000			33259	2,10	700	600	600	650	600	750	700
F350 SUPER DUTY	4x4	Super Cab	No	6.8 Box	6.0L D	6000	6390	10800			33259	2,10	700	600	600	650	600	750	700
F350 SUPER DUTY	4x4	Super Cab	No	6.8 Box	6.0L D	6000	6390	10000			33259	2,10	700	600	600	650	600	750	700
F350 SUPER DUTY	4x4	Super Cab	No	6.8 Box	6.0L D	5600	6390	10800			33259	2,10	700	600	600	650	600	1000	800
F350 SUPER DUTY	4x4	Super Cab	No	6.8 Box	6.0L D	5600	6390	10000			33259	2,10	700	600	600	650	600	1000	800
F350 SUPER DUTY	4x4	Super Cab	No	6.8 Box	6.8L V10	5600	6390	10400			33259	2,10	550	450	400	500	450	600	550
F350 SUPER DUTY	4x4	Super Cab	No	6.8 Box	6.8L V10	5600	6390	10000			33259	2,10	550	450	400	500	450	600	550
F350 SUPER DUTY	4x4	Super Cab	No	6.8 Box	6.8L V10	5200	6390	10400			33259	2,10	550	450	400	500	450	700	550
F350 SUPER DUTY	4x4	Super Cab	No	6.8 Box	6.8L V10	5200	6390	10000			33259	2,10	550	450	400	500	450	700	550
F350 SUPER DUTY	4x4	Super Cab	No	8.0 Box	5.4L V8	5600	6390	10400			33259	2,10	500	400	400	450	400	550	500
F350 SUPER DUTY	4x4	Super Cab	No	8.0 Box	5.4L V8	5600	6390	10000			33259	2,10	500	400	400	450	400	550	500
F350 SUPER DUTY	4x4	Super Cab	No	8.0 Box	5.4L V8	5200	6390	10400			33259	2,10	500	400	400	450	400	650	500
F350 SUPER DUTY	4x4	Super Cab	No	8.0 Box	5.4L V8	5200	6390	10000			33259	2,10	500	400	400	450	400	650	500
F350 SUPER DUTY	4x4	Super Cab	No	8.0 Box	6.0L D	6000	6390	11000			33259	2,10	700	650	600	650	650	800	750
F350 SUPER DUTY	4x4	Super Cab	No	8.0 Box	6.0L D	6000	6390	10000			33259	2,10	700	650	600	650	650	800	750
F350 SUPER DUTY	4x4	Super Cab	No	8.0 Box	6.0L D	5600	6390	11000			33259	2,10	1000	650	600	800	650	---	---
F350 SUPER DUTY	4x4	Super Cab	No	8.0 Box	6.0L D	5600	6390	10000			33259	2,10	1000	650	600	800	650	---	---
F350 SUPER DUTY	4x4	Super Cab	No	8.0 Box	6.8L V10	5600	6390	10600			33259	2,10	550	450	450	500	500	600	600
F350 SUPER DUTY	4x4	Super Cab	No	8.0 Box	6.8L V10	5600	6390	10000			33259	2,10	550	450	450	500	500	600	600
F350 SUPER DUTY	4x4	Super Cab	No	8.0 Box	6.8L V10	5200	6390	10600			33259	2,10	650	450	450	500	500	---	900
F350 SUPER DUTY	4x4	Super Cab	No	8.0 Box	6.8L V10	5200	6390	10000			33259	2,10	650	450	450	500	500	---	900
F350 SUPER DUTY	4x4	Super Cab	Yes	8.0 Box	5.4L V8	5600	9000	12400			33259	2,10	100	---	---	50	50	150	150
F350 SUPER DUTY	4x4	Super Cab	Yes	8.0 Box	5.4L V8	5200	9000	12400			33259	2,10	100	---	---	50	50	150	150
F350 SUPER DUTY	4x4	Super Cab	Yes	8.0 Box	5.4L V8	4800	9000	12400			33259	2,10	350	---	---	100	50	800	550
F350 SUPER DUTY	4x4	Super Cab	Yes	8.0 Box	6.0L D	6000	9000	13000			33259	2,10	500	---	---	450	400	550	500
F350 SUPER DUTY	4x4	Super Cab	Yes	8.0 Box	6.0L D	5600	9000	13000			33259	2,10	---	---	---	1000	800	---	---
F350 SUPER DUTY	4x4	Super Cab	Yes	8.0 Box	6.8L V10	6000	9000	12600			33259	2,10	300	---	---	250	250	350	350
F350 SUPER DUTY	4x4	Super Cab	Yes	8.0 Box	6.8L V10	5600	9000	12600			33259	2,10	300	---	---	250	250	350	350
F350 SUPER DUTY	4x4	Super Cab	Yes	8.0 Box	6.8L V10	5200	9000	12600			33259	2,10	---	---	---	800	600	---	---

- Notes:**
- Ballast amounts are based on a "Representative Vehicle," defined in the vehicle selection guide instructions, and must be modified for all other configurations for axle and GVWR compliance.
 - Recommended snowplow prep package whenever available.
 - May require bumper or air dam notching.

2006 Ford

Section 3 MVP® & MVP PLUS™ Blades

MVP®		MVP PLUS™				
8'-6" STEEL	7'-6" STEEL	7'-6" POLY	8'-6" STEEL	8'-6" POLY	9'-6" STEEL	9'-6" POLY
IUMVP85	IUMVPP75	IUMVPPY75	IUMVPP85	IUMVPPY85	IUMVPP95	IUMVPPY95
Blade Assembly	63819	44475	44575	44485	44585	44495
AQ&L Assembly Box 1	63910	44225				
AQ&L Assembly Box 2	67951-2					
Hydraulic Kit	64777					
Light Kit	28800					
Choose a Joystick Control or Hand-Held Control	96369	96700				
	96462	96600				

Model	Body Style	DRW	Box Option	Engine Type	Min F G A W R	Min R G A W R	Min G V W R	Harness Kit	UltraMount® system		Blade Dimensions						
									Mount Kit	Notes	1	2	3	4	5	6	
F350 SUPER DUTY	4x4	Crew Cab	No	6.8 Box	5.4L V8	5600	6390	10400	33259	2,10	450	350	350	400	400	500	500
F350 SUPER DUTY	4x4	Crew Cab	No	6.8 Box	5.4L V8	5600	6390	10000	33259	2,10	450	350	350	400	400	500	500
F350 SUPER DUTY	4x4	Crew Cab	No	6.8 Box	5.4L V8	5200	6390	10400	33259	2,10	450	350	350	400	400	650	500
F350 SUPER DUTY	4x4	Crew Cab	No	6.8 Box	5.4L V8	5200	6390	10000	33259	2,10	450	350	350	400	400	650	500
F350 SUPER DUTY	4x4	Crew Cab	No	6.8 Box	6.0L D	6000	6390	11000	33259	2,10	700	600	550	650	600	750	700
F350 SUPER DUTY	4x4	Crew Cab	No	6.8 Box	6.0L D	6000	6390	10000	33259	2,10	700	600	550	650	600	750	700
F350 SUPER DUTY	4x4	Crew Cab	No	6.8 Box	6.0L D	5600	6390	11000	33259	2,10	1000	600	550	750	600	---	---
F350 SUPER DUTY	4x4	Crew Cab	No	6.8 Box	6.0L D	5600	6390	10000	33259	2,10	1000	600	550	750	600	---	---
F350 SUPER DUTY	4x4	Crew Cab	No	6.8 Box	6.8L V10	5600	6390	10600	33259	2,10	500	400	400	450	450	550	550
F350 SUPER DUTY	4x4	Crew Cab	No	6.8 Box	6.8L V10	5600	6390	10000	33259	2,10	500	400	400	450	450	550	550
F350 SUPER DUTY	4x4	Crew Cab	No	6.8 Box	6.8L V10	5200	6390	10600	33259	2,10	650	400	400	450	450	---	900
F350 SUPER DUTY	4x4	Crew Cab	No	6.8 Box	6.8L V10	5200	6390	10000	33259	2,10	650	400	400	450	450	---	900
F350 SUPER DUTY	4x4	Crew Cab	No	8.0 Box	5.4L V8	5600	6390	10600	33259	2,10	500	400	400	450	400	550	500
F350 SUPER DUTY	4x4	Crew Cab	No	8.0 Box	5.4L V8	5600	6390	10000	33259	2,10	500	400	400	450	400	550	500
F350 SUPER DUTY	4x4	Crew Cab	No	8.0 Box	5.4L V8	5200	6390	10600	33259	2,10	600	400	400	450	400	---	850
F350 SUPER DUTY	4x4	Crew Cab	No	8.0 Box	5.4L V8	5200	6390	10000	33259	2,10	600	400	400	450	400	---	850
F350 SUPER DUTY	4x4	Crew Cab	No	8.0 Box	6.0L D	6000	6390	11200	33259	2,10	700	600	600	650	650	750	750
F350 SUPER DUTY	4x4	Crew Cab	No	8.0 Box	6.0L D	6000	6390	10000	33259	2,10	700	600	600	650	650	750	750
F350 SUPER DUTY	4x4	Crew Cab	No	8.0 Box	6.0L D	5600	6390	11200	33259	2,10	---	950	750	---	---	---	---
F350 SUPER DUTY	4x4	Crew Cab	No	8.0 Box	6.0L D	5600	6390	10000	33259	2,10	---	950	750	---	---	---	---
F350 SUPER DUTY	4x4	Crew Cab	No	8.0 Box	6.8L V10	5600	6390	10800	33259	2,10	550	450	450	500	450	600	550
F350 SUPER DUTY	4x4	Crew Cab	No	8.0 Box	6.8L V10	5600	6390	10000	33259	2,10	550	450	450	500	450	600	550
F350 SUPER DUTY	4x4	Crew Cab	No	8.0 Box	6.8L V10	5200	6390	10800	33259	2,10	---	550	450	850	650	---	---
F350 SUPER DUTY	4x4	Crew Cab	No	8.0 Box	6.8L V10	5200	6390	10000	33259	2,10	---	550	450	850	650	---	---
F350 SUPER DUTY	4x4	Crew Cab	Yes	6.8 Box	6.0L D	6000	9000	13000	33259	2,10	450	---	---	400	350	500	450
F350 SUPER DUTY	4x4	Crew Cab	Yes	6.8 Box	6.0L D	5600	9000	13000	33259	2,10	---	---	---	950	800	---	---
F350 SUPER DUTY	4x4	Crew Cab	Yes	6.8 Box	6.8L V10	5600	9000	12600	33259	2,10	250	---	---	200	200	300	300
F350 SUPER DUTY	4x4	Crew Cab	Yes	6.8 Box	6.8L V10	5200	9000	12600	33259	2,10	850	---	---	650	450	---	---
F350 SUPER DUTY	4x4	Crew Cab	Yes	8.0 Box	6.0L D	6000	9000	13000	33259	2,10	450	---	---	400	400	500	500
F350 SUPER DUTY	4x4	Crew Cab	Yes	8.0 Box	6.8L V10	6000	9000	12600	33259	2,10	300	---	---	250	200	350	300
F350 SUPER DUTY	4x4	Crew Cab	Yes	8.0 Box	6.8L V10	5600	9000	12600	33259	2,10	300	---	---	250	200	350	300
F350 SUPER DUTY	4x4	Crew Cab	Yes	8.0 Box	6.8L V10	5200	9000	12600	33259	2,10	---	---	---	900	---	---	---
F350 SUPER DUTY	4x4	All	No	Chassis	All	All	All	8501	33259	2,10	?	?	?	?	?	?	?
F350 SUPER DUTY	4x2	Reg Cab	No	8.0 Box	6.8L V10	4400	7000	10100	33259	2,10,44	---	900	750	---	1000	---	---
F350 SUPER DUTY	4x2	Reg Cab	No	8.0 Box	6.8L V10	4400	6390	10100	33259	2,10,44	---	900	750	---	1000	---	---

Notes:
 1. Ballast amounts are based on a "Representative Vehicle," defined in the vehicle selection guide instructions, and must be modified for all other configurations for axle and GVWR compliance.
 2. Recommended snowplow prep package whenever available.

10. May require bumper or air dam notching.
 44. Minimum height required from ground to foremost point on frame bottom is 22.5".

2006 Ford

Section 3 MVP® & MVP PLUS™ Blades

MVP®		MVP PLUS™				
8'-6" STEEL	7'-6" STEEL	7'-6" POLY	8'-6" STEEL	8'-6" POLY	9'-6" STEEL	9'-6" POLY
IUMV85	IUMVPP75	IUMVPPY75	IUMVPP85	IUMVPPY85	IUMVPP95	IUMVPPY95
Blade Assembly	63819	44475	44575	44485	44585	44495
AQ&L Assembly Box 1	63910	44225				
AQ&L Assembly Box 2	67951-2					
Hydraulic Kit	64777					
Light Kit	28800					
Choose a Joystick Control or Hand-Held Control	96369	96700				
	96462	96600				

Model	Body Style	DRW	Box Option	Engine Type	Min FAWR	Min RAWR	Min GVWR	Harness Kit	UltraMount® system		Blade Assembly						
									Mount Kit	Notes	IUMV85	IUMVPP75	IUMVPPY75	IUMVPP85	IUMVPPY85	IUMVPP95	IUMVPPY95
F350 SUPER DUTY	4x2	Super Cab	No	8.0 Box	5.4L V8	4550	7000	10100	33259	2,10,44	---	650	500	950	750	---	---
F350 SUPER DUTY	4x2	Super Cab	No	8.0 Box	5.4L V8	4550	6390	10100	33259	2,10,44	---	650	500	950	750	---	---
F350 SUPER DUTY	4x2	Super Cab	No	8.0 Box	6.8L V10	4700	7000	10200	33259	2,10,44	950	400	300	700	500	---	---
F350 SUPER DUTY	4x2	Super Cab	No	8.0 Box	6.8L V10	4700	6390	10200	33259	2,10,44	950	400	300	700	500	---	---
F350 SUPER DUTY	4x2	Super Cab	No	8.0 Box	6.8L V10	4550	7000	10200	33259	2,10,44	---	---	850	---	---	---	---
F350 SUPER DUTY	4x2	Super Cab	No	8.0 Box	6.8L V10	4550	6390	10200	33259	2,10,44	---	---	850	---	---	---	---
F350 SUPER DUTY	4x2	Super Cab	Yes	8.0 Box	5.4L V8	4700	9000	12200	33259	2,10,44	750	---	---	500	350	---	1000
F350 SUPER DUTY	4x2	Super Cab	Yes	8.0 Box	5.4L V8	4550	9000	12200	33259	2,10,44	---	---	---	---	950	---	---
F350 SUPER DUTY	4x2	Super Cab	Yes	8.0 Box	6.8L V10	4850	9000	12400	33259	2,10,44	550	---	---	300	100	1000	750
F350 SUPER DUTY	4x2	Super Cab	Yes	8.0 Box	6.8L V10	4700	9000	12400	33259	2,10,44	---	---	---	900	750	---	---
F350 SUPER DUTY	4x2	Crew Cab	No	6.8 Box	5.4L V8	4550	7000	10100	33259	2,10,44	---	650	500	950	800	---	---
F350 SUPER DUTY	4x2	Crew Cab	No	6.8 Box	5.4L V8	4550	6390	10100	33259	2,10,44	---	650	500	950	800	---	---
F350 SUPER DUTY	4x2	Crew Cab	No	6.8 Box	6.8L V10	4700	7000	10200	33259	2,10,44	1000	450	300	750	550	---	---
F350 SUPER DUTY	4x2	Crew Cab	No	6.8 Box	6.8L V10	4700	6390	10200	33259	2,10,44	1000	450	300	750	550	---	---
F350 SUPER DUTY	4x2	Crew Cab	No	6.8 Box	6.8L V10	4550	7000	10200	33259	2,10,44	---	---	950	---	---	---	---
F350 SUPER DUTY	4x2	Crew Cab	No	6.8 Box	6.8L V10	4550	6390	10200	33259	2,10,44	---	---	950	---	---	---	---
F350 SUPER DUTY	4x2	Crew Cab	No	8.0 Box	5.4L V8	4850	7000	10200	33259	2,10,44	350	250	250	300	300	850	600
F350 SUPER DUTY	4x2	Crew Cab	No	8.0 Box	5.4L V8	4850	6390	10200	33259	2,10,44	350	250	250	300	300	850	600
F350 SUPER DUTY	4x2	Crew Cab	No	8.0 Box	5.4L V8	4700	7000	10200	33259	2,10,44	---	500	300	800	600	---	---
F350 SUPER DUTY	4x2	Crew Cab	No	8.0 Box	5.4L V8	4700	6390	10200	33259	2,10,44	---	500	300	800	600	---	---
F350 SUPER DUTY	4x2	Crew Cab	No	8.0 Box	5.4L V8	4550	7000	10200	33259	2,10,44	---	---	1000	---	---	---	---
F350 SUPER DUTY	4x2	Crew Cab	No	8.0 Box	5.4L V8	4550	6390	10200	33259	2,10,44	---	---	1000	---	---	---	---
F350 SUPER DUTY	4x2	Crew Cab	No	8.0 Box	6.8L V10	4850	7000	10400	33259	2,10,44	800	300	300	550	400	---	---
F350 SUPER DUTY	4x2	Crew Cab	No	8.0 Box	6.8L V10	4850	6390	10400	33259	2,10,44	800	300	300	550	400	---	---
F350 SUPER DUTY	4x2	Crew Cab	No	8.0 Box	6.8L V10	4700	7000	10400	33259	2,10,44	---	950	800	---	---	---	---
F350 SUPER DUTY	4x2	Crew Cab	No	8.0 Box	6.8L V10	4700	6390	10400	33259	2,10,44	---	950	800	---	---	---	---
F350 SUPER DUTY	4x2	Crew Cab	Yes	6.8 Box	6.8L V10	4700	9000	12400	33259	2,10,44	---	---	---	---	900	---	---
F350 SUPER DUTY	4x2	Crew Cab	Yes	8.0 Box	6.8L V10	4850	9000	12600	33259	2,10,44	---	---	---	800	600	---	---
F350 SUPER DUTY	4x2	All	No	Chassis	All	All	All	10001	33259	2,10,44	?	?	?	?	?	?	?
F350 SUPER DUTY	4x2	All	Yes	Chassis	All	All	All	10001	33259	2,10,44	?	---	---	?	?	?	?
F350 SUPER DUTY 18" / 20" Tires	4x4	Reg Cab	No	8.0 Box	5.4L V8	5600	7000	10500	33259	2,10	550	450	400	450	450	600	550
F350 SUPER DUTY 18" / 20" Tires	4x4	Reg Cab	No	8.0 Box	5.4L V8	5600	7000	10000	33259	2,10	550	450	400	450	450	600	550
F350 SUPER DUTY 18" / 20" Tires	4x4	Reg Cab	No	8.0 Box	5.4L V8	5200	7000	10500	33259	2,10	550	450	400	450	450	600	550
F350 SUPER DUTY 18" / 20" Tires	4x4	Reg Cab	No	8.0 Box	5.4L V8	5200	7000	10000	33259	2,10	550	450	400	450	450	600	550
F350 SUPER DUTY 18" / 20" Tires	4x4	Reg Cab	No	8.0 Box	5.4L V8	4800	7000	10500	33259	2,10	---	600	500	900	700	---	---
F350 SUPER DUTY 18" / 20" Tires	4x4	Reg Cab	No	8.0 Box	5.4L V8	4800	7000	10000	33259	2,10	---	600	500	900	700	---	---

- Notes:**
- Ballast amounts are based on a "Representative Vehicle," defined in the vehicle selection guide instructions, and must be modified for all other configurations for axle and GVWR compliance.
 - Recommended snowplow prep package whenever available.

- May require bumper or air dam notching.
- Minimum height required from ground to foremost point on frame bottom is 22.5".

2006 Ford

Section 3

MVP® & MVP PLUS™ Blades

MVP®		MVP PLUS™				
8'-6" STEEL	7'-6" STEEL	7'-6" POLY	8'-6" STEEL	8'-6" POLY	9'-6" STEEL	9'-6" POLY
IUMV85	IUMVPP75	IUMVPPY75	IUMVPP85	IUMVPPY85	IUMVPP95	IUMVPPY95
Blade Assembly	63819	44475	44575	44485	44585	44495
AQ&L Assembly Box 1	63910	44225				
AQ&L Assembly Box 2	67951-2					
Hydraulic Kit	64777					
Light Kit	28800					
Choose a Joystick Control or Hand-Held Control	96369	96700				
	96462	96600				

Model	Body Style	DRW	Box Option	Engine Type	Min FAWR	Min RAWR	Min GVWR	Harness Kit	UltraMount® system		Blade Assembly						
									Mount Kit	Notes	IUMV85	IUMVPP75	IUMVPPY75	IUMVPP85	IUMVPPY85	IUMVPP95	IUMVPPY95
F350 SUPER DUTY 18" / 20" Tires	4x4	Reg Cab	No	8.0 Box	6.0L D	6000	7000	10000	33259	2,10	750	650	600	700	650	800	750
F350 SUPER DUTY 18" / 20" Tires	4x4	Reg Cab	No	8.0 Box	6.0L D	5600	7000	10000	33259	2,10	750	650	600	700	650	800	750
F350 SUPER DUTY 18" / 20" Tires	4x4	Reg Cab	No	8.0 Box	6.8L V10	5600	7000	10000	33259	2,10	600	500	450	550	500	650	600
F350 SUPER DUTY 18" / 20" Tires	4x4	Reg Cab	No	8.0 Box	6.8L V10	5200	7000	10000	33259	2,10	600	500	450	550	500	650	600
F350 SUPER DUTY 18" / 20" Tires	4x4	Super Cab	No	6.8 Box	5.4L V8	5600	7000	10600	33259	2,10	450	350	350	400	350	500	450
F350 SUPER DUTY 18" / 20" Tires	4x4	Super Cab	No	6.8 Box	5.4L V8	5600	7000	10000	33259	2,10	450	350	350	400	350	500	450
F350 SUPER DUTY 18" / 20" Tires	4x4	Super Cab	No	6.8 Box	5.4L V8	5200	7000	10600	33259	2,10	450	350	350	400	350	500	450
F350 SUPER DUTY 18" / 20" Tires	4x4	Super Cab	No	6.8 Box	5.4L V8	4800	7000	10600	33259	2,10	---	950	800	---	---	---	---
F350 SUPER DUTY 18" / 20" Tires	4x4	Super Cab	No	6.8 Box	5.4L V8	4800	7000	10000	33259	2,10	---	950	800	---	---	---	---
F350 SUPER DUTY 18" / 20" Tires	4x4	Super Cab	No	6.8 Box	6.0L D	6000	7000	11200	33259	2,10	700	600	550	650	600	750	700
F350 SUPER DUTY 18" / 20" Tires	4x4	Super Cab	No	6.8 Box	6.0L D	6000	7000	10000	33259	2,10	700	600	550	650	600	750	700
F350 SUPER DUTY 18" / 20" Tires	4x4	Super Cab	No	6.8 Box	6.0L D	5600	7000	11200	33259	2,10	700	600	550	650	600	---	900
F350 SUPER DUTY 18" / 20" Tires	4x4	Super Cab	No	8.0 Box	5.4L V8	5600	7000	10800	33259	2,10	500	400	350	450	400	550	500
F350 SUPER DUTY 18" / 20" Tires	4x4	Super Cab	No	8.0 Box	5.4L V8	5600	7000	10000	33259	2,10	500	400	350	450	400	550	500
F350 SUPER DUTY 18" / 20" Tires	4x4	Super Cab	No	8.0 Box	5.4L V8	5200	7000	10800	33259	2,10	500	400	350	450	400	750	550
F350 SUPER DUTY 18" / 20" Tires	4x4	Super Cab	No	8.0 Box	6.0L D	6000	7000	11400	33259	2,10	700	600	600	650	650	750	700
F350 SUPER DUTY 18" / 20" Tires	4x4	Super Cab	No	8.0 Box	6.0L D	6000	7000	10000	33259	2,10	700	600	600	650	650	750	700
F350 SUPER DUTY 18" / 20" Tires	4x4	Super Cab	No	8.0 Box	6.0L D	5600	7000	11400	33259	2,10	---	600	600	900	700	---	---
F350 SUPER DUTY 18" / 20" Tires	4x4	Super Cab	No	8.0 Box	6.0L D	5600	7000	10000	33259	2,10	---	600	600	900	700	---	---
F350 SUPER DUTY 18" / 20" Tires	4x4	Super Cab	No	8.0 Box	6.8L V10	5600	7000	10000	33259	2,10	550	450	400	500	450	600	550
F350 SUPER DUTY 18" / 20" Tires	4x4	Super Cab	No	8.0 Box	6.8L V10	5200	7000	10000	33259	2,10	800	450	400	550	450	---	---
F350 SUPER DUTY 18" / 20" Tires	4x4	Crew Cab	No	6.8 Box	5.4L V8	5600	7000	10800	33259	2,10	450	350	300	400	350	500	450
F350 SUPER DUTY 18" / 20" Tires	4x4	Crew Cab	No	6.8 Box	5.4L V8	5600	7000	10000	33259	2,10	450	350	300	400	350	500	450
F350 SUPER DUTY 18" / 20" Tires	4x4	Crew Cab	No	6.8 Box	5.4L V8	5200	7000	10800	33259	2,10	450	350	300	400	350	800	550
F350 SUPER DUTY 18" / 20" Tires	4x4	Crew Cab	No	6.8 Box	5.4L V8	5200	7000	10000	33259	2,10	450	350	300	400	350	800	550
F350 SUPER DUTY 18" / 20" Tires	4x4	Crew Cab	No	6.8 Box	6.0L D	6000	6900	11400	33259	2,10	650	600	550	600	600	700	700
F350 SUPER DUTY 18" / 20" Tires	4x4	Crew Cab	No	6.8 Box	6.0L D	6000	6900	10000	33259	2,10	650	600	550	600	600	700	700
F350 SUPER DUTY 18" / 20" Tires	4x4	Crew Cab	No	6.8 Box	6.0L D	5600	6900	11400	33259	2,10	---	600	550	900	700	---	---
F350 SUPER DUTY 18" / 20" Tires	4x4	Crew Cab	No	6.8 Box	6.0L D	5600	6900	10000	33259	2,10	---	600	550	900	700	---	---
F350 SUPER DUTY 18" / 20" Tires	4x4	Crew Cab	No	6.8 Box	6.8L V10	5600	6900	11000	33259	2,10	500	400	350	450	400	550	500
F350 SUPER DUTY 18" / 20" Tires	4x4	Crew Cab	No	6.8 Box	6.8L V10	5600	6900	10000	33259	2,10	500	400	350	450	400	550	500
F350 SUPER DUTY 18" / 20" Tires	4x4	Crew Cab	No	6.8 Box	6.8L V10	5200	6900	11000	33259	2,10	800	400	350	550	400	---	1000
F350 SUPER DUTY 18" / 20" Tires	4x4	Crew Cab	No	6.8 Box	6.8L V10	5200	6900	10000	33259	2,10	800	400	350	550	400	---	1000

- Notes:**
- Ballast amounts are based on a "Representative Vehicle," defined in the vehicle selection guide instructions, and must be modified for all other configurations for axle and GVWR compliance.
 - Recommended snowplow prep package whenever available.
 - May require bumper or air dam notching.

2006 Ford

Section 3 MVP® & MVP PLUS™ Blades

MVP®		MVP PLUS™				
8'-6" STEEL	7'-6" STEEL	7'-6" POLY	8'-6" STEEL	8'-6" POLY	9'-6" STEEL	9'-6" POLY
IUMVP85	IUMVPP75	IUMVPPY75	IUMVPP85	IUMVPPY85	IUMVPP95	IUMVPPY95
Blade Assembly 63819	44475	44575	44485	44585	44495	44595
AQ&L Assembly Box 1 63910	44225					
AQ&L Assembly Box 2 67951-2						
Hydraulic Kit 64777						
Light Kit 28800						
Choose a Joystick Control or Hand-Held Control	96369					96700
	96462					96600

Model	Body Style	DRW	Box Option	Engine Type	Min F G A W R	Min R G A W R	Min G V W R	Harness Kit	UltraMount® system		33259	2,10	500	400	350	450	400	550	500
									Mount Kit	Notes									
F350 SUPER DUTY 18" / 20" Tires	4x4	Crew Cab	No	8.0 Box	5.4L V8	6000	7000	11000											
F350 SUPER DUTY 18" / 20" Tires	4x4	Crew Cab	No	8.0 Box	5.4L V8	6000	7000	10000											
F350 SUPER DUTY 18" / 20" Tires	4x4	Crew Cab	No	8.0 Box	5.4L V8	5600	7000	11000											
F350 SUPER DUTY 18" / 20" Tires	4x4	Crew Cab	No	8.0 Box	5.4L V8	5600	7000	10000											
F350 SUPER DUTY 18" / 20" Tires	4x4	Crew Cab	No	8.0 Box	5.4L V8	5200	7000	11000											
F350 SUPER DUTY 18" / 20" Tires	4x4	Crew Cab	No	8.0 Box	5.4L V8	5200	7000	10000											
F350 SUPER DUTY 18" / 20" Tires	4x4	Crew Cab	No	8.0 Box	6.0L D	6000	6900	11500											
F350 SUPER DUTY 18" / 20" Tires	4x4	Crew Cab	No	8.0 Box	6.0L D	6000	6900	10000											
F350 SUPER DUTY 18" / 20" Tires	4x4	Crew Cab	No	8.0 Box	6.0L D	5600	6900	11500											
F350 SUPER DUTY 18" / 20" Tires	4x4	Crew Cab	No	8.0 Box	6.0L D	5600	6900	10000											
F350 SUPER DUTY 18" / 20" Tires	4x4	Crew Cab	No	8.0 Box	6.8L V10	5600	6900	11200											
F350 SUPER DUTY 18" / 20" Tires	4x4	Crew Cab	No	8.0 Box	6.8L V10	5600	6900	10000											
F350 SUPER DUTY 18" / 20" Tires	4x4	Crew Cab	No	8.0 Box	6.8L V10	5200	6900	11200											
F350 SUPER DUTY 18" / 20" Tires	4x4	Crew Cab	No	8.0 Box	6.8L V10	5200	6900	10000											
F350 SUPER DUTY 18" / 20" Tires	4x2	Reg Cab	No	8.0 Box	6.0L D	4850	7000	10700											
F350 SUPER DUTY 18" / 20" Tires	4x2	Reg Cab	No	8.0 Box	6.0L D	4850	6830	10700											
F350 SUPER DUTY 18" / 20" Tires	4x2	Reg Cab	No	8.0 Box	6.8L V10	4400	7000	10300											
F350 SUPER DUTY 18" / 20" Tires	4x2	Reg Cab	No	8.0 Box	6.8L V10	4400	6390	10300											
F350 SUPER DUTY 18" / 20" Tires	4x2	Super Cab	No	6.8 Box	5.4L V8	4400	7000	10200											
F350 SUPER DUTY 18" / 20" Tires	4x2	Super Cab	No	6.8 Box	5.4L V8	4400	6830	10200											
F350 SUPER DUTY 18" / 20" Tires	4x2	Super Cab	No	8.0 Box	5.4L V8	4700	7000	10400											
F350 SUPER DUTY 18" / 20" Tires	4x2	Super Cab	No	8.0 Box	5.4L V8	4700	6830	10400											
F350 SUPER DUTY 18" / 20" Tires	4x2	Super Cab	No	8.0 Box	5.4L V8	4550	7000	10400											
F350 SUPER DUTY 18" / 20" Tires	4x2	Super Cab	No	8.0 Box	5.4L V8	4550	6830	10400											
F350 SUPER DUTY 18" / 20" Tires	4x2	Super Cab	No	8.0 Box	5.4L V8	4550	7000	10600											
F350 SUPER DUTY 18" / 20" Tires	4x2	Super Cab	No	8.0 Box	6.8L V10	4700	7000	10600											
F350 SUPER DUTY 18" / 20" Tires	4x2	Super Cab	No	8.0 Box	6.8L V10	4700	6830	10600											
F350 SUPER DUTY 18" / 20" Tires	4x2	Super Cab	No	8.0 Box	6.8L V10	4550	7000	10600											
F350 SUPER DUTY 18" / 20" Tires	4x2	Super Cab	No	8.0 Box	6.8L V10	4550	6830	10600											
F350 SUPER DUTY 18" / 20" Tires	4x2	Super Cab	No	8.0 Box	6.8L V10	4550	7000	10400											
F350 SUPER DUTY 18" / 20" Tires	4x2	Crew Cab	No	6.8 Box	5.4L V8	4550	7000	10400											
F350 SUPER DUTY 18" / 20" Tires	4x2	Crew Cab	No	6.8 Box	5.4L V8	4550	6830	10400											
F350 SUPER DUTY 18" / 20" Tires	4x2	Crew Cab	No	6.8 Box	6.8L V10	4700	7000	10600											
F350 SUPER DUTY 18" / 20" Tires	4x2	Crew Cab	No	6.8 Box	6.8L V10	4700	6830	10600											

Notes:
 1. Ballast amounts are based on a "Representative Vehicle," defined in the vehicle selection guide instructions, and must be modified for all other configurations for axle and GVWR compliance.
 2. Recommended snowplow prep package whenever available.

10. May require bumper or air dam notching.
 44. Minimum height required from ground to foremost point on frame bottom is 22.5".

2006 Ford

Section 3

MVP® & MVP PLUS™ Blades

UltraMount							
MVP®	MVP PLUS™						
8'-6" STEEL	7'-6" STEEL	7'-6" POLY	8'-6" STEEL	8'-6" POLY	9'-6" STEEL	9'-6" POLY	
Plow	IUMVP85	IUTHVPP75	IUTHVPPY75	IUTHVPP85	IUTHVPPY85	IUTHVPP95	IUTHVPPY95
Blade Assembly	63819	44475	44575	44485	44585	44495	44595
AQ&L Assembly Box 1	63910						
AQ&L Assembly Box 2	67951-2						
Hydraulic Kit	64777	44225					
Light Kit	28800						
Choose a Joystick Control or Hand-Held Control	96369						96700
	96462						96600

Model	Body Style	DRW	Box Option	Engine Type	Min F G A W R	Min R G A W R	Min G V W R	Harness Kit	UltraMount® system		33259	2,10,44	500	250	250	300	250	1000	750
									Mount Kit	Notes									
F350 SUPER DUTY 18" / 20" Tires	4x2	Crew Cab	No	8.0 Box	5.4L V8	4850	7000	10600											
F350 SUPER DUTY 18" / 20" Tires	4x2	Crew Cab	No	8.0 Box	5.4L V8	4850	6830	10600											
F350 SUPER DUTY 18" / 20" Tires	4x2	Crew Cab	No	8.0 Box	5.4L V8	4700	7000	10600											
F350 SUPER DUTY 18" / 20" Tires	4x2	Crew Cab	No	8.0 Box	5.4L V8	4700	6830	10600											
F350 SUPER DUTY 18" / 20" Tires	4x2	Crew Cab	No	8.0 Box	6.8L V10	4850	7000	10800											
F350 SUPER DUTY 18" / 20" Tires	4x2	Crew Cab	No	8.0 Box	6.8L V10	4850	6830	10800											
F350 SUPER DUTY 18" / 20" Tires	4x2	Crew Cab	No	8.0 Box	6.8L V10	4700	7000	10800											
F350 SUPER DUTY 18" / 20" Tires	4x2	Crew Cab	No	8.0 Box	6.8L V10	4700	6830	10800											
F450 SUPER DUTY	4x4	All	Yes	Chassis	All	All	All	15000											
F450 SUPER DUTY	4x2	All	Yes	Chassis	All	All	All	15000											
F550 SUPER DUTY	4x4	All	Yes	Chassis	All	All	All	15000											
F550 SUPER DUTY	4x2	All	Yes	Chassis	All	All	All	15000											

- Notes:**
- Ballast amounts are based on a "Representative Vehicle," defined in the vehicle selection guide instructions, and must be modified for all other configurations for axle and GVWR compliance.
 - Recommended snowplow prep package whenever available.

- May require bumper or air dam notching.
- Minimum height required from ground to foremost point on frame bottom is 22.5".

2006 International

Section 2

PRO-PLOW®, PRO PLUS® & Heavy Weight Blades

UltraMount														UniMount										
PRO-PLOW®							PRO PLUS®							Heavy Weight										
7'-6" STEEL	7'-6" POLY	8'-0" STEEL	8'-0" POLY	8'-6" STEEL	7'-6" STEEL	8'-0" STEEL	8'-6" STEEL	9'-0" STEEL	9'-0" STEEL	10'-0" STEEL														
IUTP75	IUTPY75	IUTP80	IUTPY80	IUTP85	IUTPP75	IUTPP80	IUTPP85	IUTPP90	IUHW90	IUHW10														
60381	62400	60390	62450	60308	64750	66980	66974	66901	62301	62302														
67950				66490				62298-1																
67951-2					64400		62299-1																	
64588				64999				64400																
Light Kit				28800				28800																
Choose a Joystick Control or Hand-Held Control				56369				56369																
				56462				56462																
Model	Body Style	DRW	Box Option	Engine Type	Min FGAWR	Min RGAWR	Min GVWR	Harness Kit	UltraMount® system		Ballast Guidelines, lbs (1)							UniMount® system		Ballast Guidelines, lbs (1)				
									Mount Kit	Notes											Mount Kit	Notes		
4000 SERIES	4x2	All	Yes	Chassis	All	All	10001	2B use 8439 & 26640 or HB5 use 8436 & 26640	n/a	---	---	---	---	---	---	---	---	---	---	---	62275	---	?	?

Notes:
 1. Ballast amounts are based on a "Representative Vehicle," defined in the vehicle selection guide instructions, and must be modified for all other configurations for axle and GVWR compliance.

2006 Jeep

Section 1 Suburbanite™ & MIDWEIGHT™ Blades

 Suburbanite™	
6'-8" POLY	7'-4" POLY
SUB68	SUB74
Plow	
Blade Assembly	27546 27548
AQ&L Assembly Box 1	27550
AQ&L Assembly Box 2	n/a
Hydraulic Kit	27516
Light Kit	64100
Choose a Joystick Control or Hand-Held Control	56369 56462

 UltraMount™	
MIDWEIGHT™	
7'-6" STEEL	7'-6" POLY
IUTH75	IUTHY75
64340	64330
64336	
67992	
64620	
28800	
56369	
56462	

Model	Body Style	DRW	Box Option	Engine Type	Min F G A W R	Min R G A W R	Min G V W R	Harness Kit	Personal Plow system		Ballast Guidelines, lbs (1)	UltraMount® system		Ballast Guidelines, lbs (1)			
									Mount Kit	Notes		Mount Kit	Notes				
LIBERTY LIMITED	4x4	SU-4DR	No	---	3.7L V6	2750	3150	5600	HB5 use 8436	3713-1	8	0	0	n/a	---	---	---
LIBERTY SPORT	4x4	SU-4DR	No	---	3.7L V6	2750	3150	5200		3713-1	8	0	0	n/a	---	---	---
LIBERTY RENEGADE	4x4	SU-4DR	No	---	3.7L V6	2750	3150	5600		3713-1	8	0	0	n/a	---	---	---
WRANGLER SE	4x4	SU-2DR	No	---	2.4L I4	2200	2650	4450	2D use 8439	3723	8	0	0	n/a	---	---	---
GRAND CHEROKEE LAREDO	4x4	SU-4DR	No	---	3.7L V6	2950	3200	6100	HB3/HB4 use 8438 & 28027	42021	3,8	0	0	n/a	---	---	---
GRAND CHEROKEE LIMITED	4x4	SU-4DR	No	---	4.7L V8	2950	3200	6150		42021	3,8	0	0	n/a	---	---	---
GRAND CHEROKEE LIMITED	4x4	SU-4DR	No	---	5.7L V8	2950	3200	6150		42021	3,8	0	0	n/a	---	---	---
GRAND CHEROKEE OVERLAND	4x4	SU-4DR	No	---	5.7L V8	2950	3200	6100		42021	3,8	0	0	n/a	---	---	---

- Notes:**
1. Ballast amounts are based on a "Representative Vehicle," defined in the vehicle selection guide instructions, and must be modified for all other configurations for axle and GVWR compliance.
 3. Requires bumper notching.
 8. These Snowplows Are For Personal/Homeowner Use Only.

2006 Mitsubishi

Section 2

PRO-PLOW®, PRO PLUS® & Heavy Weight Blades

UltraMount								
PRO-PLOW®					PRO PLUS®			
7'-6" STEEL	7'-6" POLY	8'-0" STEEL	8'-0" POLY	8'-6" STEEL	7'-6" STEEL	8'-0" STEEL	8'-6" STEEL	9'-0" STEEL
IUTP75	IUTPY75	IUTP80	IUTPY80	IUTP85	IUTPP75	IUTPP80	IUTPP85	IUTPP90
60381	62400	60390	62450	60308	64750	66980	66974	66901
67950				66490				
67951-2					64588			
64588					64999			
28800					28800			
56369					56369			
56462					56462			

UniMount	
Heavy Weight	
9'-0" STEEL	10'-0" STEEL
IUHW90	IUHW10
62301	62302
62298-1	
62299-1	
64400	
28800	
56369	
56462	

Model	Body Style	DRW	Box Option	Engine Type	Min F G A W R	Min R G A W R	Min G V W R	Harness Kit	UltraMount® system		Ballast Guidelines, lbs (1)								UniMount® system		Ballast Guidelines, lbs (1)	
									Mount Kit	Notes	1	2	3	4	5	6	7	8	9	10	11	12
FG	4x4	All	Yes	Chassis	All	All	10001	HB5 use 8436 & 28860	33109	---	---	---	---	?	---	---	?	?	n/a	---	---	---

Notes:
 1. Ballast amounts are based on a "Representative Vehicle," defined in the vehicle selection guide instructions, and must be modified for all other configurations for axle and GVWR compliance.

2006 Mitsubishi

Section 3

MVP® & MVP PLUS™ Blades

UltraMount						
MVP®	MVP PLUS™					
8'-6" STEEL	7'-6" STEEL	7'-6" POLY	8'-6" STEEL	8'-6" POLY	9'-6" STEEL	9'-6" POLY
Plow	IUMVP85	IUTHVPP75	IUTHVPPY75	IUTHVPP85	IUTHVPPY85	IUTHVPPY95
Blade Assembly	63819	44475	44575	44485	44585	44495
AQ&L Assembly Box 1	63910					
AQ&L Assembly Box 2	67951-2	44225				
Hydraulic Kit	64777					
Light Kit	28800					
Choose a Joystick Control or Hand-Held Control	96369	96700				
	96462	96600				

Model	Body Style	DRW	Box Option	Engine Type	Min FGAWR	Min RGAWR	Min GVWR	Harness Kit	UltraMount® system		?	---	---	?	?	---	---
									Mount Kit	Notes							
FG	4x4	All	Yes	Chassis	All	All	10001	HB5 use 8436 & 28860	33109	---	?	---	---	?	?	---	---

Notes:
 1. Ballast amounts are based on a "Representative Vehicle," defined in the vehicle selection guide instructions, and must be modified for all other configurations for axle and GVWR compliance.

2006 Nissan

Section 1 Suburbanite™ & MIDWEIGHT™ Blades

 Suburbanite™	
6'-8" POLY	7'-4" POLY
SUB68	SUB74
Plow	
Blade Assembly	
AQ&L Assembly Box 1	27546 27548
AQ&L Assembly Box 2	27550
Hydraulic Kit	n/a
Light Kit	27516
Choose a Joystick Control or Hand-Held Control	64100
	56369
	56462

 UltraMount™	
MIDWEIGHT™	
7'-6" STEEL	7'-6" POLY
IUTH75	IUTHY75
	64340 64330
	64336
	67992
	64620
	28800
	56369
	56462

Model	4x4	Body Style	DRW	Box Option	Engine Type	Min F G A W R	Min R G A W R	Min G V W R	Harness Kit	Personal Plow system		Ballast Guidelines, lbs (1)	UltraMount® system		Ballast Guidelines, lbs (1)		
										Mount Kit	Notes		Mount Kit	Notes			
TITAN XE	4x4	King Cab	No	6.5 Box	5.6L V8	3577	3800	6522	HB3/HB4 use 27480-1 & 28027	31303	8,40	---	0	n/a	---	---	---
TITAN XE	4x4	Crew Cab	No	6.5 Box	5.6L V8	3577	3800	6522		31303	8,40	---	0	n/a	---	---	---
TITAN SE	4x4	King Cab	No	6.5 Box	5.6L V8	3577	3800	6522		31303	8,40	---	0	n/a	---	---	---
TITAN SE	4x4	Crew Cab	No	6.5 Box	5.6L V8	3577	3800	6522		31303	8,40	---	0	n/a	---	---	---
TITAN LE	4x4	King Cab	No	6.5 Box	5.6L V8	3577	3800	6522		31303	8,40	---	0	n/a	---	---	---
TITAN LE	4x4	Crew Cab	No	6.5 Box	5.6L V8	3577	3800	6522		31303	8,40	---	100	n/a	---	---	---

- Notes:**
- Ballast amounts are based on a "Representative Vehicle," defined in the vehicle selection guide instructions, and must be modified for all other configurations for axle and GVWR compliance.
 - These Snowplows Are For Personal/Homeowner Use Only.
 - Removal of skid plate or splash guard required.

2006 Toyota

Section 1 Suburbanite™ & MIDWEIGHT™ Blades

 Suburbanite™	
6'-8" POLY	7'-4" POLY
SUB68	SUB74
Plow Blade Assembly	27546 27548
AQ&L Assembly Box 1	27550
AQ&L Assembly Box 2	n/a
Hydraulic Kit	27516
Light Kit	64100
Choose a Joystick Control or Hand-Held Control	56369 56462

 UltraMount™	
MIDWEIGHT™	
7'-6" STEEL	7'-6" POLY
IUTH75	IUTHY75
64340	64330
64336	
67992	
64620	
28800	
56369	
56462	

Model	4x4	Body Style	DRW	Box Option	Engine Type	Min F G A W R	Min R G A W R	Min G V W R	Harness Kit	Personal Plow system		Ballast Guidelines, lbs (1)	UltraMount® system		Ballast Guidelines, lbs (1)		
										Mount Kit	Notes		Mount Kit	Notes			
TACOMA	4x4	Reg Cab	No	6.1 Box	2.7L I4	2755	3110	5100	HB2 use 8439	32323	8	0	0	n/a	---	---	---
TACOMA	4x4	Access Cab	No	6.1 Box	2.7L I4	2755	3110	5350		32323	8	0	50	n/a	---	---	---
TACOMA	4x4	Access Cab	No	6.1 Box	4.0L V6	2755	3110	5350		32323	8	150	250	n/a	---	---	---
TACOMA	4x4	Double Cab	No	5.0 Box	4.0L V6	2755	3110	5450		32323	8	350	500	n/a	---	---	---
TACOMA	4x4	Double Cab	No	6.1 Box	4.0L V6	2755	3110	5450		32323	8	600	700	n/a	---	---	---
TUNDRA	4x4	Reg Cab	No	8.0 Box	4.7L V8	3160	3760	6300		2303	8	---	0	n/a	---	---	---
TUNDRA SR5	4x4	Ext Cab	No	6.1 Box	4.7L V8	3160	3760	6300		2303	8	---	300	n/a	---	---	---
TUNDRA SR5	4x4	Double Cab	No	6.1 Box	4.7L V8	3500	3760	6600		2303	8	---	0	n/a	---	---	---
TUNDRA LIMITED	4x4	Ext Cab	No	6.1 Box	4.7L V8	3160	3760	6300		2303	8	---	200	n/a	---	---	---
TUNDRA LIMITED	4x4	Double Cab	No	6.1 Box	4.7L V8	3500	3760	6600		2303	8	---	0	n/a	---	---	---

- Notes:**
- Ballast amounts are based on a "Representative Vehicle," defined in the vehicle selection guide instructions, and must be modified for all other configurations for axle and GVWR compliance.
 - These Snowplows Are For Personal/Homeowner Use Only.

HEADLAMP REFERENCE GUIDE

NOTE: The lamp type is usually embossed in the headlamp lens.

NOTE: Blue ground wires may be LT or DK BLU, w/ or w/o WHT stripe, depending on harness.

Headlamp Type	Bulb Type	Headlamp Type	Bulb Type
LF	H4703	2E1	H6545
UF	H4701	H13	9008
1A1	H4651	HB1	9004
2A1	H4652(GMC/Chevy)	HB2	9003
2A1	H4656 (Mitsubishi)	HB3	9005
2B1	H6054	HB4	9006
2D1	H6024	HB5	9007

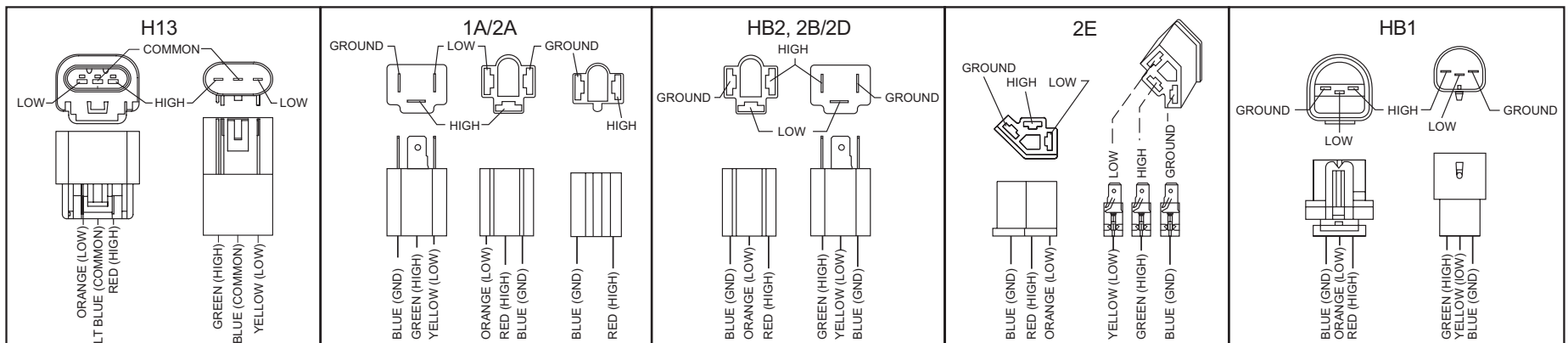
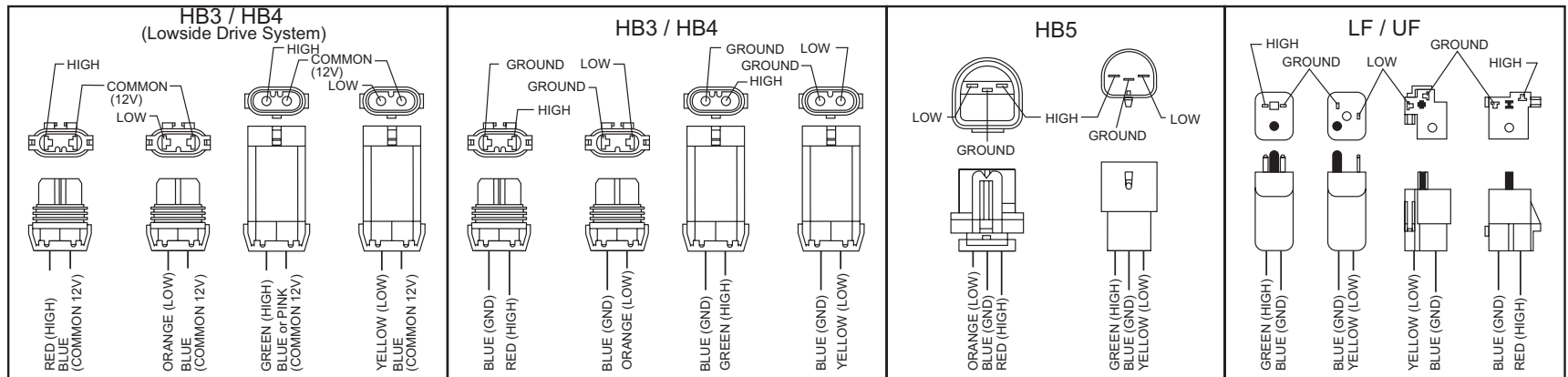

WEIGHT AND DIMENSIONAL CHARTS

Plows and Accessories Information										
Plows		Accessories – Part Number (Effective Added Weight in lb)								Var.
Size	Wt. (lb)	HD Poly Deflector	Rubber Deflector	Cutting Edge 1/2"	Back Drag Edge 1/4"	Wing Kit	Shoes	Curb Guard	Dolly Wheel	Z (in)
SUB68	239	—	—	—	—	—	27710 (5.7)	—	—	20.4
SUB74	257	—	—	—	—	—	27710 (5.7)	—	—	20.8
IUTM75	540	63700 (19.1)	62123 (29.6)	—	64758 (47.0)	—	64392 (21.1)	44404 (61.3)	—	20.4
IUTMY75	532	63700 (19.1)	62123 (29.6)	—	64758 (47.0)	—	64392 (21.1)	44404 (61.6)	—	20.3
IUTP75	682	63700 (19.2)	62123 (29.7)	49346 (25.8)	64758 (47.0)	—	—	44403 (63.8)	—	20.8
IUTPY75	719	—	—	49350 (24.8)	64758 (47.0)	—	—	44403 (58.4)	—	22.7
IUTP80	699	63670 (20.1)	62530 (33.8)	49347 (27.4)	66892 (60.6)	—	—	44403 (62.3)	—	21.3
IUTPY80	727	—	—	49351 (26.9)	66892 (60.6)	—	—	44403 (59.0)	—	22.5
IUTP85	715	63670 (21.1)	62220 (35.5)	49348 (28.8)	66999 (63.5)	—	—	44403 (61.7)	—	21.5
IUTPP75	789	63700 (12.4)	62123 (28.9)	—	64758 (59.7)	64410 (90)	—	44404 (41.2)	—	26.1
IUTPP80	805	63670 (13.3)	62530 (32.2)	—	66892 (63.2)	64410 (90)	—	44404 (40.7)	—	26.4
IUTPP85	821	63670 (14.2)	62220 (35.5)	—	66999 (66.2)	64410 (90)	—	44404 (40.3)	—	26.7
IUTPP90	837	63670 (15.0)	62220 (37.1)	—	66991 (69.2)	64410 (90)	—	44404 (39.8)	—	27.0
IMVP85	899	—	—	28409 (41.6)	—	—	—	—	—	24.0
IUTMVPP75	827	—	44278 (*)	44284 (*)	—	44276 (*)	44277 (*)	44404 (25.2)	—	18.4
IUTMVPPY75	799	—	44278 (*)	44284 (*)	—	44276 (*)	44277 (*)	44404 (25.5)	—	18.4
IUTMVPP85	880	—	44279 (*)	44285 (*)	—	44276 (*)	44277 (*)	44404 (24.0)	—	18.3
IUTMVPPY85	847	—	44279 (*)	44285 (*)	—	44276 (*)	44277 (*)	44404 (24.1)	—	18.3
IUTMVPP95	1006	—	44280 (*)	—	—	44276 (*)	44277 (*)	44404 (22.8)	—	18.8
IUTMVPPY95	964	—	44280 (*)	—	—	44276 (*)	44277 (*)	44404 (23.5)	—	18.8
IUHW90	1048	—	62220 (37.8)	—	—	—	—	44404 (33.7)	62430 (24.8)	33.0
IUHW10	1106	—	62124 (45.8)	—	—	—	—	44404 (33.1)	62430 (24.8)	33.6
—	—	UltraMount to UniMount Conversion Kit 27170 (94.0)								Varies

* This part number is currently not available for purchase, thus finalized weights have not been established. Once weights are established and product is available, finalized weights will be published.

Mount Information							
Mount	Weight (lb)	X (in)	Y (in)	Mount	Weight (lb)	X (in)	Y (in)
Suburbanite™ Mounts							
1203	34.0	27.0	6.0	2313	30.0	27.0	5.0
1213-1	23.0	26.0	6.0	3713-1	20.0	26.0	5.0
1223	40.0	28.0	7.0	3723	35.0	21.4	5.0
1233	34.0	32.0	7.1	31303	43.0	27.9	4.8
1503	26.0	27.0	6.0	31543	20.0	28.5	7.1
1523	26.0	30.0	6.0	32323	36.0	30.0	7.3
1533-1	31.0	26.0	5.0	33903	45.0	31.0	7.8
2303	41.0	29.0	6.0	42021	37.0	29.0	8.0
UniMount® and UltraMount® Mounts							
1369	80.0	32.9	8.3	63760	40.0	30.0	8.0
1379	83.0	32.9	8.3	63883-2	47.0	37.0	6.9
3249	65.0	30.4	9.8	63900	87.0	29.6	12.5
3919	47.0	30.1	8.5	64110	115.0	38.0	10.0
33109	110.0	38.0	7.0	64500	33.0	32.5	8.9
33259	43.0	33.5	10.8	67810	44.0	35.1	8.7
33559	115.0	38.0	10.0	67865	41.0	31.3	7.6
33929	39.0	32.5	8.1	67960-1	34.0	29.1	7.6
30999	40.0	33.5	8	67980	51.0	35.0	8.5
62275	Varies			67981-2	54.0	32.4	11.4
63710-1	87.0	27.8	5.7	67982	69.0	30.4	9.0

NOTE: The addition of accessories to a snowplow or vehicle will require additional ballast above any amount published in this guide in order to maintain FMVSS compliance. Completed vehicle with additional accessories shall not exceed GVWR or GAWR.

NOTE: An abbreviation key is on page 2.

NOTE: See next page for variable definitions.

DIMENSIONAL DIAGRAM

Variables:

X = Distance from center of front axle to receiver pin

Y = Distance from receiver pin to CG of mount.

Z = Distance from receiver pin to CG of snowplow.

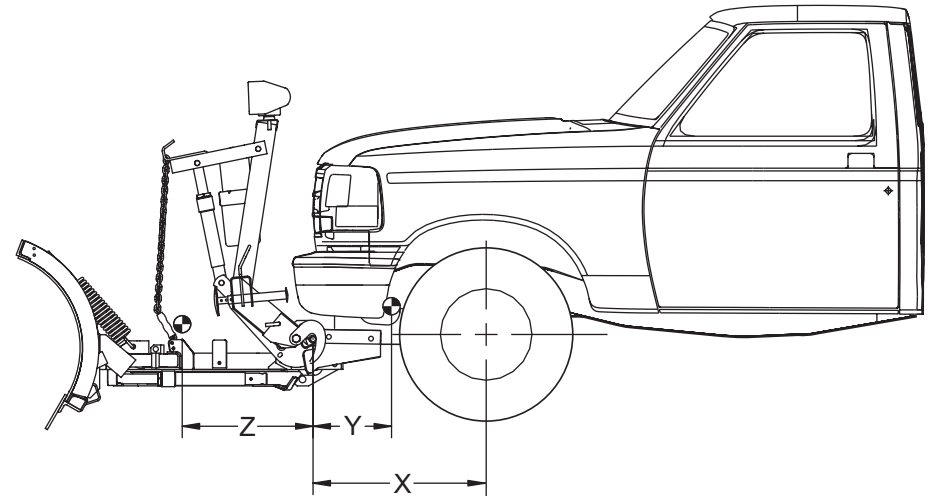

Example: Weight that one would use if they had an IUTP75 with the poly deflector and a 1/2" cutting edge.

The weight of the plow alone with no accessories would be 682 lb with its center of gravity 20.8 in from the coupling point. To add the weight of the accessories, look in the row with the IUTP75 blade to find the effective poly deflector weight of 19.2 lb and the effective cutting edge weight of 25.8 lb.

The total weight of the blade and accessories will be:

$$\begin{array}{r}
 682.0 \\
 19.2 \\
 + 25.8 \\
 \hline
 727.0
 \end{array}$$

with its center of gravity still at 20.8 in from the coupling point

ALWAYS comply with the vehicle manufacturer's stated gross vehicle and axle weight ratings (found on

the driver-side door jamb of the vehicle) and front and rear weight distribution ratio with the snowplow installed. In some cases, rear ballast may be required to achieve these requirements.

Available vehicle capacities for aftermarket equipment and components can be determined by using the above information along with information provided by the vehicle manufacturer's Body Builder Guides. Follow all requirements and recommendations as stated by vehicle manufacturer.

NOTE: An abbreviation key is on page 2.

VEHICLE AND PLOW APPLICATION INQUIRY SHEET



Western Products
7777 North 73rd Street
Milwaukee, WI 53223

Telephone (414) 354-2310
Fax (414) 354-6664

DISTRIBUTOR		TEL
		FAX

CUSTOMER	
VIN	DATE BUILT

SELECT MOUNT TYPE	<input type="checkbox"/> UniMount [®]	<input type="checkbox"/> UltraMount [®]	<input type="checkbox"/> Conversion Kit
	<input type="checkbox"/> Suburbanite [™]		

VEHICLE INFORMATION

YEAR			
MAKE			
MODEL			
DRIVE TRAIN	<input type="checkbox"/> 4x2 (over 10,000 lb. GVW only)	<input type="checkbox"/> 4x4	<input type="checkbox"/> ALL WHEEL <input style="width: 50px;" type="text"/> OTHER
DRW (Dual Rear Wheels)	<input type="checkbox"/> YES	<input type="checkbox"/> NO	
BODY STYLE	<input type="checkbox"/> REG CAB	<input type="checkbox"/> EXT CAB	<input style="width: 50px;" type="text"/> OTHER
BOX OPTION (S)	<input type="checkbox"/> DUMP BOX	<input type="checkbox"/> STAKE BED	<input style="width: 50px;" type="text"/> OTHER
ENGINE TYPE			
GFAWR			
GRAWR			
GVWR			

HORIZONTAL DISTANCE DESCRIPTION

L31	DRIVERS hip point; in MIDDLE position, to Centerline of FRONT axle	(in.)
L101	Between axles (Wheelbase)	(in.)
L104	Middle of FRONT bumper to centerline of FRONT axle	(in.)
	Middle of ballast location to centerline of REAR axle	(in.)

VEHICLE WEIGHT (TRUCK MUST BE WEIGHED COMPLETE AND EMPTY (-) OCCUPANTS, PLOW & MOUNT)

FRONT (lb.)	REAR (lb.)

FUEL TANKS (ONLY NEEDED IF WEIGHED VEHICLE NOT FULLY FUELED)

	LEVEL (see below)	CAPACITY (gal.)	LOCATION FROM AXLE TO CENTER OF TANK(in.)
FRONT OF AXLE			
REAR OF AXLE			

FUEL LEVEL (EMPTY = 0, HALF = 1/2, FULL = 1)

THIS FORM *MUST* BE COMPLETED IN ITS ENTIRETY. ANY FORMS CONTAINING INCOMPLETE INFORMATION *WILL NOT BE CONSIDERED*. PLEASE RETURN VIA FAX (414) 354-6664.

Western Products or the vehicle manufacturer may require or recommend optional equipment for snow removal.
See the WESTERN[®] Selection List for additional product information.

UltraMount® SYSTEM TO UniMount® SYSTEM CONVERSION KIT (PN 27170)

⚠ WARNING

Conversion kit use is limited to vehicles up to 19,500 lb GVWR.

⚠ WARNING

Do not exceed GVWR or GAWR, including blade and ballast. The rating label is found on the driver-side vehicle door cornerpost.

This easy to use UltraMount system to UniMount system conversion kit enables you to attach a UniMount plow to a vehicle equipped with an UltraMount mount.

Simply remove the receivers from your UltraMount system mount, and pin the conversion plate in place. This accessory is perfect for customers with multiple snowplows, providing their fleet with versatility while changing to the UltraMount system.

This new kit is also ideal for transferring an old UniMount plow to a new truck. As new trucks are released, we will develop only new UltraMount mounts for these plow applications. This will allow the customer to transfer an existing UniMount plow to the late model vehicle. In addition, when customers are ready to replace their old UniMount plow, the truck will already have the mount and wiring for an UltraMount plow.

TO QUALIFY THE VEHICLE AND DETERMINE BALLAST, YOU MUST FILL OUT THE VEHICLE AND PLOW APPLICATION INQUIRY SHEET.

NOTE: When ballast is required, it should be secured behind the rear wheels in a manner which prevents it from sliding during normal driving. Western Products offers an options ballast retainer kit (PN 62849) for this purpose.

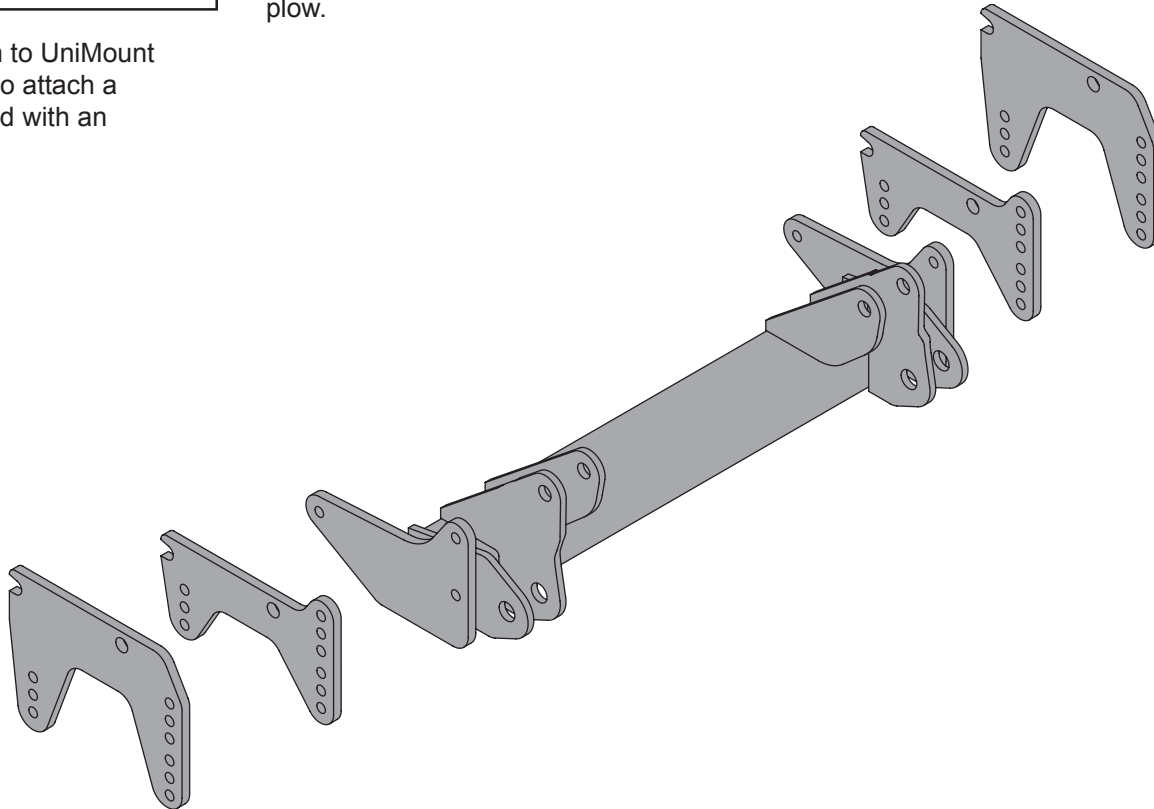

Notes:



WESTERN PRODUCTS
P.O. BOX 245038
MILWAUKEE, WI 53224-9538

 A DIVISION OF DOUGLAS DYNAMICS, L.L.C.

Western Products reserves the right under its product improvement policy to change construction or design details and furnish equipment when so altered without reference to illustrations or specifications used. Western Products or the vehicle manufacturer may require or recommend optional equipment for snow removal. Do not exceed vehicle ratings with a snowplow. Western Products offers a limited warranty for all snowplows and accessories. See separately printed page for this important information. The following are registered (®) or unregistered (™) trademarks of Douglas Dynamics, L.L.C.: MIDWEIGHT™, MVP®, MVP PLUS™, POLY PRO-PLOW®, PRO-PLOW®, PRO PLUS®, Suburbanite™, UltraMount®, UniMount®, WESTERN®.

Printed in U.S.A.