

1533-1

MOUNT KIT PERSONAL PLOW

Chevrolet Trailblazer

2002 - 09

GMC Envoy

2002 - 09

Installation Instructions

⚠ CAUTION

Read this document before installing the snowplow.

⚠ CAUTION

See your sales outlet/website for specific vehicle application recommendations before installation. The online selection system has specific vehicle and snowplow requirements.

SAFETY DEFINITIONS

⚠ WARNING
 Indicates a potentially hazardous situation that, if not avoided, could result in death or serious personal injury.

⚠ CAUTION
 Indicates a potentially hazardous situation that, if not avoided, may result in minor or moderate injury. It may also be used to alert against unsafe practices.

NOTE: Indicates a situation or action that can lead to damage to your snowplow and vehicle or other property. Other useful information can also be described.

WARNING/CAUTION & INSTRUCTION LABELS

Become familiar with and inform users about the warning/caution and instruction labels on the back of the blade.

NOTE: If labels are missing or cannot be read, see your sales outlet.

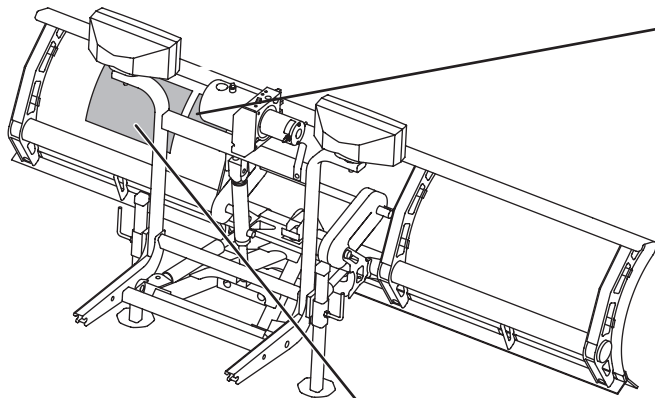

Warning/Caution Label

⚠ WARNING	
	Lower blade when vehicle is parked.
	Do not exceed GVWR or GAWR including blade and ballast.
⚠ CAUTION	
	Read Owner's Manual before operating or servicing snowplow.
	Transport speed should not exceed 45 mph (72 km/h). Further reduce speed under adverse travel conditions.
	Plowing speed should not exceed 10 mph (16 km/h).
	See your sales outlet/Web site for specific vehicle application recommendations.

Instruction Label

This snowplow is for personal/homeowner use only.

<p>ATTACH INSTRUCTIONS</p> <ol style="list-style-type: none"> 1. Make certain both connecting pins are fully retracted. 2. Drive vehicle slowly to completely insert attachment arms into receiver assembly slots. 	<ol style="list-style-type: none"> 3. Twist both connecting pins to release spring tension, then push plow gear toward vehicle so connecting pins fully engage holes in attachment arms. 4. Loosen one jack handle and slide jack sleeve down below jack retainer. Remove jack and retighten jack handle. Repeat for other jack and store them. 5. Connect all electrical cables from vehicle to snowplow.
<ol style="list-style-type: none"> 5. Back vehicle away from snowplow. 6. See Owner's Manual for proper snowplow storage. 	<p>DETACH INSTRUCTIONS</p> <ol style="list-style-type: none"> 1. Put blade on ground using LOWER/FLOAT on snowplow control. Leave control ON and in FLOAT. 2. Attach jacks. Loosen jack handle, put jack on ground, and raise jack sleeve until fully engaging jack retainer. Tighten jack handle. Repeat for other jack. 3. While pushing plow gear toward vehicle to release connecting pin tension, pull connecting pin out on one side and twist pin handle to keep pin retracted. Repeat procedure for other connecting pin. 4. Disconnect all electrical cables.

U.S. patents 6,253,470; 6,941,685; 7,400,058; 7,737,576; and other patents pending.

Read Owner's Manual for complete instructions.

SAFETY PRECAUTIONS

Improper installation and operation could cause personal injury and/or equipment and property damage. Read and understand labels and the Owner's Manual before installing, operating or making adjustments.

⚠ WARNING

Lower the blade when vehicle is parked. Temperature changes could change hydraulic pressure, causing the blade to drop unexpectedly or damaging hydraulic components. Failure to do this could result in serious personal injury.

⚠ WARNING

The driver shall keep bystanders clear of the blade when it is being raised, lowered or angled. Do not stand between the vehicle and the blade or within 8 feet of a moving blade. A moving or falling blade could cause personal injury.

⚠ WARNING

Keep hands and feet clear of the blade and A-frame when mounting or removing the snowplow. Moving or falling assemblies could cause personal injury.

⚠ WARNING

Do not exceed GVWR or GAWR including the blade and ballast. The rating label is found on the driver-side vehicle door cornerpost.

⚠ WARNING

To prevent accidental movement of the blade, always turn the control OFF whenever the snowplow is not in use. The power indicator light will turn OFF.

⚠ WARNING

Remove blade assembly before placing vehicle on hoist.

⚠ CAUTION

Refer to the online selection system for minimum vehicle recommendations and ballast requirements.

PERSONAL SAFETY

- Remove the ignition key and put the vehicle in park or in gear to prevent others from starting the vehicle during installation or service.
- Wear only snug-fitting clothing while working on your vehicle or snowplow.
- Do not wear jewelry or a necktie, and secure long hair.
- Wear safety goggles to protect your eyes from battery acid, gasoline, dirt and dust.
- Avoid touching hot surfaces such as the engine, radiator, hoses and exhaust pipes.
- Always have a fire extinguisher rated BC handy, for flammable liquids and electrical fires.

FIRE AND EXPLOSION

⚠ WARNING

Gasoline is highly flammable and gasoline vapor is explosive. Never smoke while working on vehicle. Keep all open flames away from gasoline tank and lines. Wipe up any spilled gasoline immediately.

Be careful when using gasoline. Do not use gasoline to clean parts. Store only in approved containers away from sources of heat or flame.

CELL PHONES

A driver's first responsibility is the safe operation of the vehicle. The most important thing you can do to prevent a crash is to avoid distractions and pay attention to the road. Wait until it is safe to operate Mobile Communication Equipment such as cell phones, text messaging devices, pagers or two-way radios.

VENTILATION

⚠ WARNING

Vehicle exhaust contains lethal fumes. Breathing these fumes, even in low concentrations, can cause death. Never operate a vehicle in an enclosed area without venting exhaust to the outside.

NOISE

Airborne noise emission during use is below 70 dB(A) for the snowplow operator.









VIBRATION

Operating snowplow vibration does not exceed 2.5 m/s² to the hand-arm or 0.5 m/s² to the whole body.

TORQUE CHART

⚠ CAUTION

Read instructions before assembling. Fasteners should be finger tight until instructed to tighten according to the torque chart. Use standard methods and practices when attaching snowplow, including proper personal protective safety equipment.

Recommended Fastener Torque Chart					
Inch Fasteners Grade 5 and Grade 8					
Size	Torque (ft-lb)		Size	Torque (ft-lb)	
	 Grade 5	 Grade 8		 Grade 5	 Grade 8
1/4-20	8.4	11.9	9/16-12	109	154
1/4-28	9.7	13.7	9/16-18	121	171
5/16-18	17.4	24.6	5/8-11	150	212
5/16-24	19.2	27.3	5/8-18	170	240
3/8-16	30.8	43.6	3/4-10	269	376
3/8-24	35.0	49.4	3/4-16	297	420
7/16-14	49.4	69.8	7/8-9	429	606
7/16-20	55.2	77.9	7/8-14	474	669
1/2-13	75.3	106.4	1-8	644	909
1/2-20	85.0	120.0	1-12	704	995
Metric Fasteners Class 8.8 and 10.9					
Size	Torque (ft-lb)		Size	Torque (ft-lb)	
	 Class 8.8	 Class 10.9		 Class 8.8	 Class 10.9
M6 x 1.00	7.7	11.1	M20 x 2.50	325	450
M8 x 1.25	19.5	26.9	M22 x 2.50	428	613
M10 x 1.50	38.5	53.3	M24 x 3.00	562	778
M12 x 1.75	67	93	M27 x 3.00	796	1139
M14 x 2.00	107	148	M30 x 3.50	1117	1545
M16 x 2.00	167	231	M33 x 3.50	1468	2101
M18 x 2.50	222	318	M36 x 4.00	1952	2701

These torque values apply to fasteners except those noted in the instructions.

INSTALLATION INSTRUCTIONS

NOTE: For easier assembly and installation, vehicle and all snowplow components should be on a smooth, level, hard surface, such as concrete.

1. Remove plastic grille by gently pulling on grille until push clips release.
2. Remove two plastic push button retainers from lower corners of front bumper cover. Remove four plastic push rivets from below and behind the license plate bracket. Remove the two bolts from the top of the bumper cover and remove the plastic bumper cover.
3. Remove the bumper by removing the two larger bumper fasteners.
4. Next remove the tow hooks, and the plastic air box from the bumper.
5. Reinstall the bumper using the 1/2" x 7" cap screw and 1/2" hardened washer. Do not install the nuts on these fasteners.
6. Install the mount to the bottom of the vehicle using the previously installed bumper fasteners, and 1/2" locknuts.

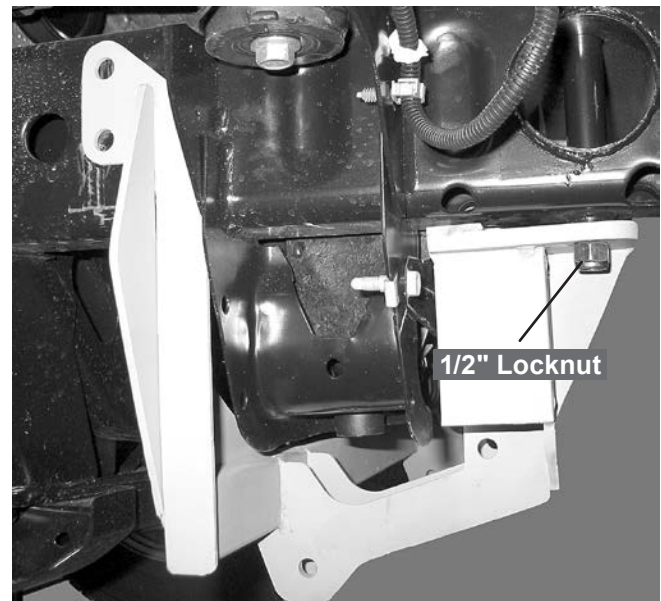

7. Loosely install the supplied 3/8" x 1-1/4" cap screw with 3/8" washer and 3/8" locknut in the inner mount holes.

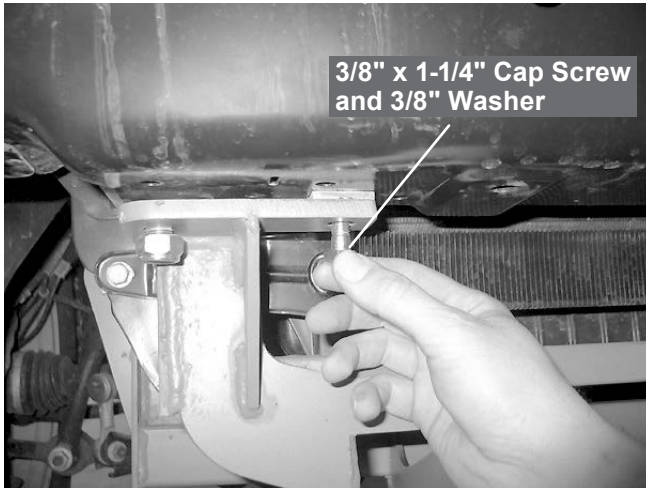

8. Make sure mount is tight to the bottom of the vehicle frame, and tighten the previously installed inner mount fasteners, followed by the bumper fasteners.

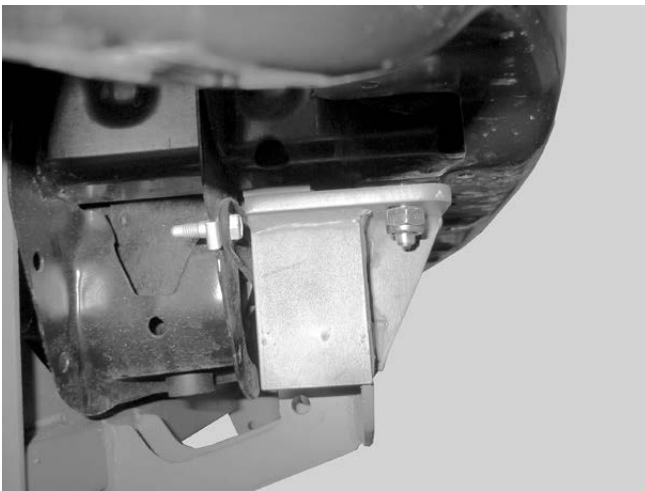

9. Hold rear of mount tight to the bottom of frame using a floor jack.

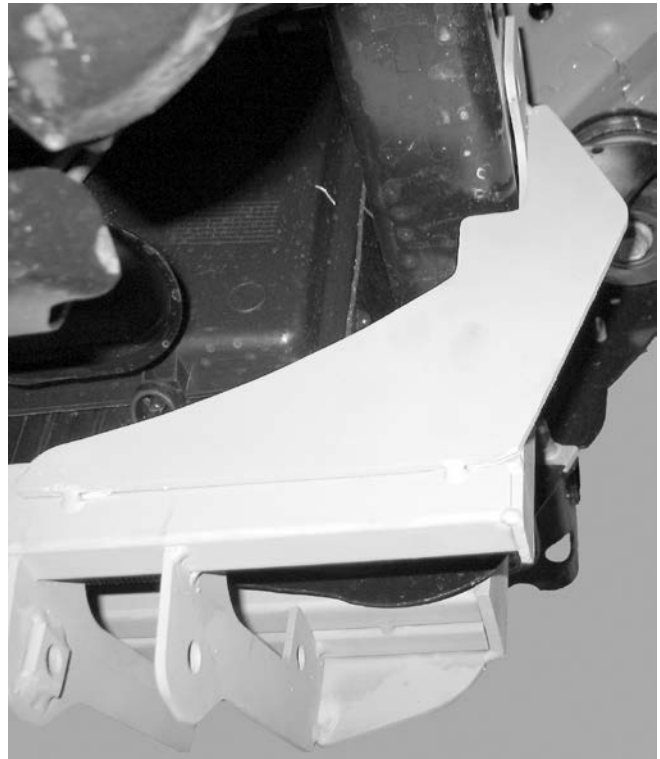

10. Using the holes in the rear of the mount as a template, drill four 9/16" holes in vehicle frame.



11. Using large access hole in the vehicle frame behind the mount install the supplied cap screws with handles, 1/2" washers and 1/2" locknuts through the previously drilled holes.

Trim off any excess handle length that may interfere with moving parts of the vehicle.

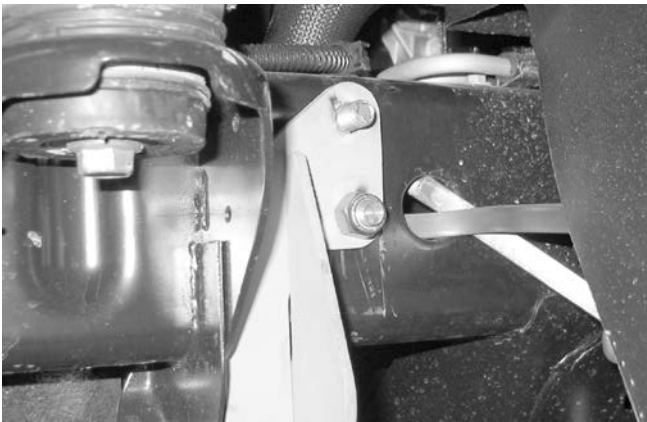

12. Tighten all fasteners according to the torque chart.
13. Trim plastic radiator air box as shown, and reinstall on vehicle.

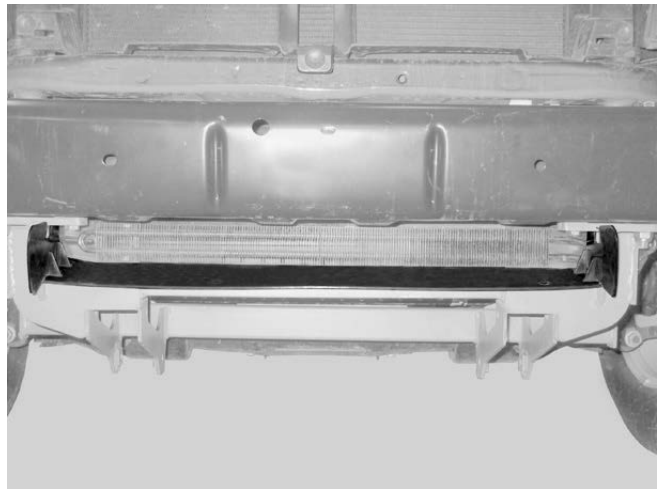
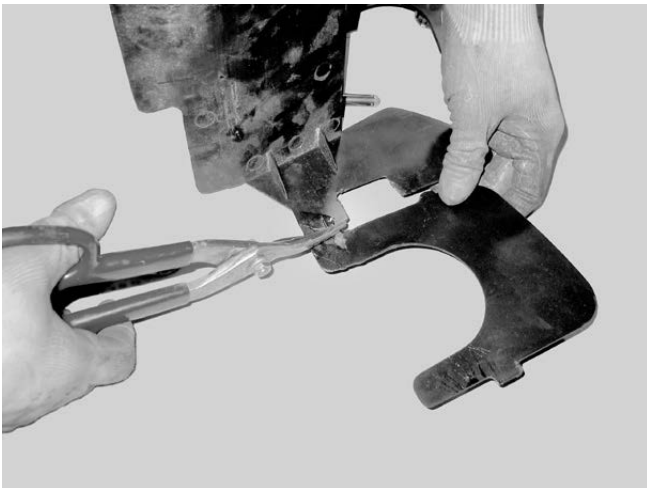

14. Reinstall bumper cover and grille.
15. Remove or trim air dam as required.

NOTE: After five to ten hours of snowplow usage, retorque all mount assembly fasteners.

The company reserves the right under its product improvement policy to change construction or design details and furnish equipment when so altered without reference to illustrations or specifications used. This equipment manufacturer or the vehicle manufacturer may require or recommend optional equipment for snow removal. Do not exceed vehicle ratings with a snowplow. The company offers a limited warranty for all snowplows and accessories. See separately printed page for this important information.

Printed in U.S.A.
